

The Keadby 3 Low Carbon Gas Power Station Project

Document Ref: 6.3

Planning Inspectorate Ref: EN010114

The Keadby 3 (Carbon Capture Equipped Gas Fired Generating Station) Order

**Land at and in the vicinity of the Keadby Power Station site,
Trentside, Keadby, North Lincolnshire**

Environmental Statement

Volume II - Appendix 13A: Phase 1 Desk Based Assessment

The Planning Act 2008

**The Infrastructure Planning (Environmental Impact Assessment)
Regulations 2017**

Applicant: Keadby Generation Limited

Date: May 2021

DOCUMENT HISTORY

Document Ref	6.3.23/Appendix 13A
Revision	VP1.0
Document Owner	AECOM

CONTENTS

1.0	Introduction.....	1
1.1	Overview	1
1.2	Report Objectives.....	2
1.3	Sources of Information	2
1.4	Study Area.....	4
2.0	Site Description and Setting	6
2.1	Site Setting and Surrounding Land Use	6
3.0	Site Inspection	8
3.1	Overview	8
3.2	Proposed PCC Site (Area to accommodate CCGT and CO ₂ Capture Plant) 8	
3.3	Keadby 1 Power Station Site.....	8
3.4	Electrical Connection Area	11
4.0	Environmental Setting	12
4.1	Introduction.....	12
4.2	Soils Classification	12
4.3	Geology	12
4.4	Soil Chemistry	14
4.5	Hydrogeology	14
4.6	Hydrology	16
4.7	Minerals Safeguarding and Mineral Extraction	20
4.8	Radon.....	21
4.9	Unexploded Ordnance.....	21
4.10	Utilities.....	21
5.0	Regulated Activities	23
5.1	Introduction.....	23
5.2	Regulated Processes	23
5.3	Waste Management Facilities	25
5.4	Hazardous Substances	28
5.5	Contemporary Trade Directory Entries	29
5.6	Pollution Incidents	29
5.7	Sensitive Land Uses.....	29
6.0	Historical Development.....	32
6.1	Introduction.....	32
6.2	Proposed Development Site.....	32
6.3	Study Area.....	33
6.4	A18 Access Road and Study Area	34
7.0	Previous Ground Investigations.....	35
7.1	Introduction.....	35
7.2	URS (2018) Design of a Site Protection and Monitoring Programme for Keadby Generation Ltd, Keadby Power Station	35
7.3	Structural Soils (2017) Keadby Power Station, Geo-environmental Report37	
7.4	Environmental Resources Management (2017) Project Keadby Power Station: Phase 1 Desk Study Report.....	38

7.5	Environmental Resources Management (2017) Phase II Baseline Investigation Keadby	40
7.6	Environmental Resources Management (2016) Keadby 2 Power Station Environmental Statement	42
7.7	Structural Soils (2016) Interpretive Geotechnical Assessment on Ground Investigation	45
7.8	Structural Soils (2016) Additional Geotechnical Reports	45
7.9	RSK (2016) Keadby Power Station, Preliminary Risk Assessment	46
7.10	URS (2012) SSE Keadby, High pH (Alkaline) Drainage Water Options Appraisal	47
7.11	URS (2010) Keadby Power Station, Environmental Site Assessment	48
7.12	Exploration Associates (2002) Settlement Monitoring, Keadby Power Station	49
7.13	SSE (1999) Keadby Power Station, Permitted Preliminary Works and Access Road, Discovery of Asbestos 11 September 1998 – Close Out Report	49
7.14	Mouchel (1992) Geotechnical Interpretative Report	50
7.15	Mott MacDonald (1991) Report on Pile Testing and Concrete Coring/Laboratory Testing	51
7.16	Mott MacDonald (1991) Project Phoenix, Proposed Groundwater Abstraction	51
8.0	Initial Conceptual Site Model	53
8.1	Introduction	53
8.2	Sources of Potential Contamination	53
8.3	Potential Pathways	56
8.4	Potential Receptors	56
9.0	Environmental Risk Assessment	58
9.1	Risk Assessment Principles	58
9.2	Preliminary Risk Assessment	60
9.3	Discussion of Risks to Construction Workers and Off-site Receptors during Construction Works	70
10.0	Preliminary Ground Engineering Risk Assessment	71
11.0	Conclusions	75
11.1	Summary	75
12.0	Recommendations	77
12.1	Summary	77
13.0	References	78
ANNEX A	Figures	81
ANNEX B	Historical Maps provided by Envirocheck	82
ANNEX C	Preliminary UXO Threat Assessment	83
ANNEX D	Utility Plans	84

TABLES

Table 1: Features surrounding the Proposed Development Site	7
Table 2: Geological succession from published mapping and historical borehole logs	13

Table 3: Estimated soil chemistry.....	14
Table 4: Surface water features	16
Table 5: Environment Agency licensed surface water abstractions	18
Table 6: Summary of indicated services.....	21
Table 7: Summary of regulatory information – industrial processes.....	23
Table 8: Summary of regulatory information – waste management processes	26
Table 9: Summary of sensitive land uses.....	29
Table 10: Potential sources of contamination.....	54
Table 11: Potential Pathways.....	56
Table 12: Potential receptors	56
Table 13: Severity of the risk.....	58
Table 14: Likelihood of risk occurrence.....	59
Table 15: Risk based on comparison of likelihood and severity	60
Table 16: Preliminary risk assessment.....	61
Table 17: Summary of the ground-related risks	71

1.0 INTRODUCTION

1.1 Overview

1.1.1 This Appendix supplements **Chapter 13: Geology, Hydrogeology and Land Contamination (ES Volume I - Application Document Ref. 6.2)** and presents the phase 1 desk-based geo-environmental assessment for the Proposed Development.

1.1.2 The Proposed Development is for a Low Carbon Combined Cycle Gas Turbine (CCGT) Generating Station on land at, and in the vicinity of, the existing Keadby Power Station.

1.1.3 The Proposed Development Site is located to the west of Trent Side Road (B1392), to the west of the village of Keadby, near Scunthorpe. The town of Scunthorpe is located approximately 5km to the east. The Proposed Development Site is centred on approximate National Grid Reference SE828116. The site location plan is presented as **Figure 13A.1** (ES Volume II - **Application Document Ref. 6.3**) and a site layout plan is presented in **Annex A** of this report as **Figure 13A.2 1** (ES Volume II - **Application Document Ref. 6.3**).

1.1.4 For the purposes of this report, the Proposed Development Site consists of a number of areas corresponding with the different parts of the Proposed Development. These are outlined below and illustrated on **Figure 13A.3 1** (ES Volume II - **Application Document Ref. 6.3**), in **Annex A** of this report:

- Proposed Power Station and Carbon Capture Site (Proposed PCC Site);
- Electrical Connection Area to National Grid 400 kilovolt (kV) Substation;
- Emergency Vehicle Access Road and Potential Electrical Connection to 132kV Substation;
- Water Connection Corridors (River Water Abstraction Option; Canal Water Abstraction Option);
- Water Discharge Corridor;
- Land within the Keadby Power Station site for the purposes of facilitating connections to the Proposed Development for natural gas supply, and other necessary infrastructure (including 'Gas Connection Corridor');
- Waterborne Transport Offloading Area;
- Additional Abnormal Indivisible Load Route;
- Construction Laydown Areas;
- A18 Junction Improvement; and
- Construction and Operational Vehicular Site Access Route and Gatehouse.

1.2 Report Objectives

1.2.1 This report has been used to establish the baseline conditions at the Proposed Development Site; it is also a necessary precursor to any ground investigation that may be required to support the preliminary design following the Development Consent Order (DCO) application submission.

1.2.2 Current industry guidance supports the preparation of a development-specific desk study as a necessary precursor to any intrusive works for new development. The desk study defines the plausible risks that may be present on a site, and hence the need for any further remediation or investigation. By undertaking a desk study first, this ensures that subsequent intrusive works (if required) are proportionate, cost effective and designed specifically for the ground conditions expected.

1.2.3 The scope of this Appendix is to:

- review the Proposed Development Site's geological, hydrological and hydrogeological setting, and other geo-environmental information obtained from the Landmark Information Group (April 2020) to build up an understanding of the environmental setting and sensitivity;
- review the historical development and land use at the Proposed Development Site and in the surrounding area, with an emphasis on identifying potential on-site and off-site contamination sources;
- carry out a site inspection to identify any current potential contamination sources as well as possible indicators of contamination;
- review any previous investigation reports or studies;
- review any geo-hazards or outline geotechnical constraints;
- develop an initial Conceptual Site Model (CSM) describing significant source-pathway-receptor linkages followed by a preliminary risk assessment; and
- outline the scope of any further investigation or remediation, as required.

1.3 Sources of Information

1.3.1 This Appendix draws on information from a combination of the following sources:

- historical mapping included as part of a professional Envirocheck Report provided by the Landmark Information Group (April 2020) presented in **Annex B**;
- standard Envirocheck data and site sensitivity information provided by the Landmark Information Group (in GIS data format – April 2020);
- British Geological Survey (BGS) Geological Mapping and Memoirs <https://www.bgs.ac.uk/data/maps/maps.cfc?method=listResults&MapName=&series=E50k&scale=&pageSize=100&getLatest=Y>;

- Environment Agency website;
- BGS Geoindex website <https://www.bgs.ac.uk/geoindex/>;
- Cranfield Soil and AgriFood Institute (CSAI) Soilscales website <http://www.landis.org.uk/soilscales/>;
- stakeholder consultation;
- Trent and Peak Archaeology. A geoarchaeological hand auger survey at Keadby 3 Low Carbon Gas Power Station, Lincolnshire (2021);
- Magnitude Surveys. Geophysical Survey Report for Keadby, North Lincolnshire (2021);
- URS. Design of a Site Protection and Monitoring Programme for Keadby Generation Ltd, Keadby Power Station (2018);
- Structural Soils. Keadby Power Station, Geo-environmental Report (2017);
- Environmental Resources Management. Phase II Baseline Investigation Keadby (2017);
- Environmental Resources Management. Project Keadby Power Station: Phase 1 Desk Study Report (2017);
- Environmental Resources Management. Keadby 2 Power Station Environmental Statement (2016);
- Structural Soils. Interpretive Geotechnical Assessment on Ground Investigation (2016);
- Structural Soils. Additional Geotechnical Reports (2016);
- RSK. Keadby Power Station, Preliminary Risk Assessment (2016);
- URS. SSE Keadby, High pH (Alkaline) Drainage Water Options Appraisal (2012);
- URS. Environmental Site Assessment (2010);
- Exploration Associates. Settlement Monitoring: Keadby Power Station (2002);
- SSE. Keadby Power Station, Permitted Preliminary Works and Access Road, Discovery of Asbestos 11 September 1998 – Close Out Report (1999);
- Mouchel. Geotechnical Interpretative Report (1992);
- Mott MacDonald. Report on Pile Testing and Concrete Coring/Laboratory Testing (1991);
- Mott MacDonald. Project Phoenix, Proposed Groundwater Abstraction (1991);
- National Library of Scotland website (accessed February 2021), <https://www.nls.uk/>;

- Current and recent-historical mapping from Google Earth Pro (accessed February 2021);
- Department for Environment Food and Rural Affairs (DEFRA) Magic website <https://magic.defra.gov.uk/>;
- UK radon website provided by Public Health England <https://www.ukradon.org/information/ukmaps/>;
- Zetica website for preliminary information on unexploded ordnance (UXO) <https://zeticauxo.com/downloads-and-resources/risk-maps/>; and
- 6 Alpha Associates – Preliminary UXO Threat Assessment

1.4 Study Area

- 1.4.1 For the purposes of determining the local baseline conditions with respect to geology and land contamination, a study area that extends 250m from the boundary of the Proposed Development Site is adopted (see **Figure 13A.2 1** (ES Volume II - **Application Document Ref. 6.3**) in **Annex A** of this report). This is extended for hydrogeology to 1km from the boundary of the Proposed Development Site. This is appropriate to assess the local geological and hydrogeological setting, and any influence that potential contaminated land might have on the Proposed Development or local receptors. However, the baseline conditions in terms of soil chemical quality, where available, will be based on information directly within the Proposed Development Site only.
- 1.4.2 The proposed access road from the A18 and the potential laydown areas in adjacent agricultural fields are included in the Proposed Development Site as illustrated on **Figure 3.3: Areas Referred to in the Environmental Statement** (ES Volume III – **Application Document Ref. 6.4**). Additional third-party data from the Landmark Information Group has not been obtained for all of this area, and specific additional stakeholder engagement has not been carried out. However, a review of publicly available data sources has been undertaken to supplement the baseline conditions information for these areas and this has included a review of potential sources of contamination. The data sources referenced are indicated in Section 13.3.17, Structure of this Report
- 1.4.3 The following figures are provided to support this Appendix at the end of this report:
- **Figure 13A.1** – Site Location Plan;
 - **Figure 13A.2** – DCO Site; and
 - **Figure 13A.3** – Indicative Work Areas Referred to in the ES.
- 1.4.4 The following annexes are provided to support this Appendix (also at the end of this report):
- **Annex A:** Plans and Site Walkover Record;
 - **Annex B:** Historical Mapping;

- **Annex C:** Unexploded Ordnance Report; and
- **Annex D:** Utility Information.

2.0 SITE DESCRIPTION AND SETTING

2.1 Site Setting and Surrounding Land Use

2.1.1 The Proposed Development Site covers an area of approximately 69.4 hectares (ha) and is currently occupied by the following:

- Keadby Power Station, including numerous above ground tanks in the central/ eastern area;
- a large 400kV electricity substation operated by National Grid in the northern area;
- predominantly open land in the west (Keadby Common) including areas of former agricultural land¹ (used by the Keadby 2 Power Station construction project as lay-down and temporary spoil storage) with further open land on the eastern spurs (proposed Water Connection Corridor) and access road from the A18 and potential laydown options in adjacent agricultural fields; and
- a pumping station and residential housing are located on the eastern-most extent of the eastern spur and a pumping station is also located on the north-eastern spur.

2.1.2 A further 20.7ha of land is included as potential construction laydown, and has been subject to options appraisal, and assessment.

2.1.3 Land within and surrounding the Proposed Development Site is generally low lying at elevations below 10m Above Ordnance Datum (mAOD) and with very shallow gradients. According to the Environment Agency Digital Terrain Model, the ground level varies from a low point of approximately 0m AOD, to a high point of 4m AOD within the Proposed PCC Site. The majority of the Proposed Development Site lies between 0 and 2m AOD, including the Proposed PCC Site.

2.1.4 A notable steep ridge is present immediately to the west of the Proposed PCC Site (outside the Proposed Development Site boundary) where land associated with the former Ash Tip is in excess of 19m AOD.

2.1.5 Levels on the Keadby 1 and Keadby 2 Power Station sites are slightly elevated compared to the surrounding land within the Proposed Development Site, with levels typically between 1 and 3m AOD. Levels within the construction laydown areas (farmland) are typically circa 1m AOD.

¹ The part of Keadby Common on which the Proposed PCC Site is to be located was previously occupied by a tenant farmer and used for agricultural purposes. The Applicant released the land from the tenancy in 2018 and it is therefore now back under the Applicant's full control.

2.1.6 Relevant features immediately surrounding the Proposed Development Site (within the study area) are summarised in Table 1, below.

Table 1: Features surrounding the Proposed Development Site

Direction	Summary
North	Keadby Wind Farm, additional areas of Keadby Common, agricultural land and watercourses (see Section 4.6 for further details).
South	Scunthorpe to Doncaster passenger railway line adjacent to the south-west of the Proposed PCC Site. Sheffield and South Yorkshire Navigation (canal), Stainforth and Keadby Canal and other watercourses (see Section 4.6 for further details) and agricultural land beyond this, and beyond the A18 junction.
East	Keadby village, Trent Side Road (B1392), River Trent, PD Ports (Marina) and wharf, pumping stations, electricity substations, a depot.
West	Open land (former Keadby Ash Tip and agricultural land).

3.0 SITE INSPECTION

3.1 Overview

- 3.1.1 An external inspection of the Proposed Development Site was completed by a suitably qualified and experienced AECOM Engineer on 16 July 2020. The aim of the visit was to identify the range of activities carried out at the Proposed Development Site and to note any visible potential sources of ground contamination or geotechnical issues.
- 3.1.2 During the site visit, the AECOM Engineer was accompanied by representatives of the Applicant who provided a tour of the operational parts of the Keadby 1 Power Station site. Areas excluded from the walkover due to safety constraints included the Keadby 2 construction site and the Keadby 2 Laydown Area.
- 3.1.3 A summary of the principal observations made during the site inspection is provided below. A photographic record of the visit is included as **Annex B**.

3.2 Proposed PCC Site (Area to accommodate CCGT and CO₂ Capture Plant)

- 3.2.1 The Proposed PCC Site on which both the CCGT and Carbon Capture Plant (CCP) are situated is occupied by former agricultural land associated with Keadby Common and lies north and north-west of the Keadby 2 Laydown Area.
- 3.2.2 During the walkover, it was noted that the southern portion of this area has been converted to temporary spoil storage whereas the northern portion has been left untouched.
- 3.2.3 The spoil storage was noted to be formed of mounds and excavations; deeper excavations were found to exist to the west of the area compared to the east. The highest mounds were also recorded to the west of the area compared to the east.
- 3.2.4 A watercourse was noted to span the southern and western perimeter of both areas. On the spoil heap, a blue pipe was noted to be present that was positioned in the spoil heap and in the adjacent watercourse. Although unconfirmed by site representatives, it appeared to potentially be related to dewatering the spoil storage area.
- 3.2.5 On the spoil heap, surface erosion was recorded in the form of rills. No gullies were noted to be present.

3.3 Keadby 1 Power Station Site

- 3.3.1 Entrance to the Keadby 1 Power Station was via the gate house located to the north-east of the Proposed Development Site off Trent Road.
- 3.3.2 To the south-east of this area, a waste oil and gas cylinder storage area was noted to be present along with a water treatment works. Three cages of

propane and butane gas cylinders were recorded with a waste oil area positioned adjacent. Contents of the waste oil area included one bunded waste oil container, two 1000 litre waste oil containers, intermediate bulk containers (IBC), thirteen 250 litre barrels of insulating oil that were stood upright and placed on top of pallets directly onto the concrete beneath and various smaller containers of waste lubricating oil that were also placed directly onto the concrete. The condition of the concrete in the waste oil area was noted to be in good condition with no cracks present nor was there any evidence of surface staining. However, cracks in the hardstanding adjacent to the waste oil area were noted.

- 3.3.3 The area of the Water Treatment Works was found to contain five above ground storage tanks (AST). Two of the tanks were labelled as containing sodium hypochlorite, however these were reported to be empty by the site representative. A third tank contained caustic soda, the fourth contained sulphuric acid and the fifth contained alum for use in waste purification. All the tanks were contained within a concrete bund.
- 3.3.4 Further east, a scaffold storage area was noted together with a cage of gas cylinders stored in this area. A fabrication workshop was also noted adjacent to the scaffold area.
- 3.3.5 Running along the southern perimeter of Keadby 1 Power Station site are four large AST for the storage of demineralised water.
- 3.3.6 To the south of the Keadby Power Station site a fire fighting pump house was noted, which contained two pumps, each of which had diesel tanks positioned on top of each pump. The tanks appeared to be in good order and no surface staining of fuel was noted on the ground. It was reported by site representatives that fire-fighting exercises are carried out at Keadby 1 Power Station; however, the site representative informed AECOM that the use of fire-fighting foams e.g. Aqueous Film Forming Foams (AFFF) are not used during the exercises. Quantities of AFFF are stored at the Keadby Power Station site, however the location and quantities stored were not reported during the walkover.
- 3.3.7 Two gas heaters were located to the south-west of the Keadby 1 Power Station site.
- 3.3.8 In the western part of the Keadby 1 Power Station site is the auxiliary boiler house, adjacent to which four AST were noted. Two were for the storage of waste lubricating oil, with the remaining two for the storage of clean lubricating oil. All four AST were located inside a concrete bund.
- 3.3.9 The western perimeter of the Keadby 1 Power Station site was fenced off with herras fencing demarking the boundary between Keadby 1 Power Station and the current boundary of the Keadby 2 Power Station construction site. Observations were made from Keadby 1 Power Station site towards Keadby 2 Power Station construction site and noted a single large AST to the south-west of Keadby 1 Power Station and three large AST grouped together to the

west. The contents of the AST are unknown. As this part of the Keadby 2 construction site could not be accessed, during the site inspection, the state and condition of these AST and bunding is not known.

- 3.3.10 In the north-west of the Keadby 1 Power Station, a fenced off compound is present for the storage of multiple hydrogen cylinders and an AST of liquid carbon dioxide.
- 3.3.11 To the north of the Keadby 1 Power Station site, 400kV transformers were noted for the distribution of electricity off-site. The transformers were reportedly built in the early 1990's and therefore, present a low risk for containing polychlorinated biphenyls (PCB). East of the transformers was an open area where a network of closed cycle cooling water pipes exists.
- 3.3.12 To the centre of the Keadby 1 Power Station site was the main boiler house. The main boiler house was not entered during the site inspection. Adjacent to the main boiler house to the east were two buildings housing emergency diesel generators. Access to the diesel generators was not conducted during the site inspection. An additional waste area was present at the centre of the Keadby 1 Power Station site and contained non-hazardous general waste, plastic recycling, a small battery waste container, a large battery waste container, a cabinet containing empty chemical drums, a cabinet containing Waste Electrical and Electronic Equipment (WEEE) and a container for hazardous fluorescent tubes. Hazardous lamps storage and aerosol containers (some spent) were also present. The condition of the hardstanding in this area was noted to be in a good condition with no cracks present. A building housing a hot works area was also present. A small area of ponded water was present at the centre of the Keadby 1 Power Station site; however, this was noted to be due to a rise in elevation of the roadway.
- 3.3.13 To the north-east of the Keadby 1 Power Station site, a large AST containing distillate fuel oil was present for use in gas turbine 3 to the west. The AST is contained in a large concrete bund. Adjacent to the AST is an additional waste oil storage area. The waste oil areas contained three 1000 litre capacity IBC and a 1000 litre capacity IBC containing glycol. The IBC were not bunded, however the hardstanding was observed to be in good condition and no staining on the ground was observed.
- 3.3.14 No constraints for any potential ground investigation were recorded for Keadby 1 Power Station, however considerations must be taken to ensure services are cleared prior to the progression of exploratory locations. A discharge point was also recorded off site north-east of the gate house, approximately 25m from the Proposed Development Site boundary that discharges to the drainage ditches that extend off site within agricultural fields. Access to the discharge point could not be granted at the time of the site inspection.

3.4 Electrical Connection Area

- 3.4.1 The majority of this area is occupied by road/ track and open land. In the eastern extent is a large corrugated metal and brick building with adjacent car park and metal fencing around, including warning signs for electric shock risk. Approximately 60m to the west of this building is a disused farm (adjacent to the Proposed Development Site boundary).

4.0 ENVIRONMENTAL SETTING

4.1 Introduction

- 4.1.1 The environmental setting including the topography, geology, hydrogeology and hydrology are the key factors that influence the way in which contaminants in the soil or groundwater can be transported on or off site, and the way in which contamination can affect users of the Proposed Development Site.
- 4.1.2 The environmental setting of the Proposed Development Site has been assessed by making reference to the information sources detailed in Section 1.4.

4.2 Soils Classification

- 4.2.1 Information obtained from Cranfield Soil and AgriFood Institute (CSAI) Soilscales website (CSAI, 2020) describes the soils on the Proposed Development Site to be loamy and clayey soils of coastal flats with naturally high groundwater (Soilscape identification description number 21). Land within this soil type is described as generally draining to local groundwater and mostly drained. Shallow groundwater and marginal ditches to most fields mean that the water resource is vulnerable to pollution from nutrients, pesticides and wastes that may be applied to the land.
- 4.2.2 According to the Landmark Information Group GIS data, Natural England reports the Agricultural Land Classification (ALC) to be Grade 2 for the Proposed Development Site. This is classed as soil of '*very good quality*'. This land is further described as having only minor limitations which affect crop yield, cultivations or harvesting. It can support a wide range of agricultural and horticultural crops but there can be some reduced flexibility on land within the grade, which causes difficulty in the production of more demanding crops e.g. winter harvested vegetables and arable root crops.
- 4.2.3 The ALC within and around the proposed access road from the A18 and the construction laydown areas in adjacent agricultural fields is Grade 1. This is classed as soil of '*excellent quality*'. This land is further described as having no or very minor limitations. A very wide range of agricultural and horticultural crops can be grown.

4.3 Geology

- 4.3.1 The BGS Geoindex website and published 1:50,000 scale geological maps of the area (Sheet 88, Doncaster and Sheet 79, Goole) have been reviewed, alongside the historical borehole records available from the Proposed PCC Site. The historical ground investigations are described in greater detail in Section 7.0. These records indicate that the Proposed Development Site is underlain by the geological succession summarised in Table 2.

Table 2: Geological succession from published mapping and historical borehole logs

Geology	Expected Location	Anticipated thickness	British Geological Survey (BGS) lithological description
Made Ground	Although not mapped at the site, Made Ground is expected across the Proposed Development Site given the historical site use.	Up to 2m	Artificial deposits on the natural ground's surface.
Warp (artificially induced Alluvium)	Across the majority of the Proposed Development Site and the study area.	12 – 17m	Clay and silt.
Cohesive Alluvium	Eastern extent of the Proposed Development Site and study area.		Normally soft to firm consolidated, compressible silty clay, but can contain layers of silt, sand, peat and basal gravel.
Granular Alluvium	Beneath the Cohesive Alluvium.		Sands, silts and clays, with occasional peat layers (peat layers recorded between 0.45m and 1.6m thickness). Sands sometimes described as ' <i>blown sands</i> ' ¹ .
Mercia Mudstone Group (bedrock)	Across the Proposed Development Site and study area, beneath the superficial deposits.	Up to 200m	Dominantly red, less commonly green-grey, mudstones and subordinate siltstones with thick halite-bearing units in some basal areas. Thin beds of gypsum/anhydrite widespread; sandstones are also present.

¹ Blown sand; defined by BGS as sand that has been transported by wind, or sand consisting predominantly of wind-borne particles

4.3.2 No faults have been identified in the vicinity of the Proposed Development Site.

4.4 Soil Chemistry

4.4.1 BGS Soil Chemistry datasets detail the topsoil concentrations of five potentially harmful elements (PHE): arsenic (As), cadmium (Cd), copper (Cu), nickel (Ni) and lead (Pb). Elevated concentrations of these PHE can exist because of natural geological conditions or possible anthropogenic sources. The estimated soil chemistry levels attributed to the Proposed Development Site are set out in Table 3.

Table 3: Estimated soil chemistry

Potentially Harmful Element	Estimated geometric mean concentration range within the Proposed Development Site boundary (mg/kg)
Arsenic	South-western area (around the northern area of the proposed A18 access road and laydown area) – 18.9 – 25.8 Remainder of the Proposed Development Site and study area – 14.1 – 18.9
Cadmium	South-central area of the Proposed Development Site – 0.49 – 0.85 Remainder of the Proposed Development Site and study area – <0.33
Copper	Whole of the Proposed Development Site and study area – 15.4 – 35.0
Lead	South-western area (around the northern area of the proposed A18 access road and laydown area) – 99.5 – 242 Remainder of the Proposed Development Site and study area – 47.1 – 99.5
Nickel	South-western area (around the northern area of the proposed A18 access road and laydown area) – 31.9 – 40.1 Remainder of the Proposed Development Site and study area – 23.5 – 31.9

4.5 Hydrogeology

Aquifer Classification

4.5.1 The Environment Agency's Groundwater Protection Policy (Environment Agency, 2018) adopts aquifer designations that are consistent with the Water Framework Directive (WFD) (Water Framework Directive 2000/60/EC).

4.5.2 The superficial geology (Alluvium/ Warp) is classified as a Secondary A aquifer. These are permeable layers capable of supporting water supplies at a local rather than strategic scale, and in some cases forming an important source of base flow to rivers. Based on the WFD, this groundwater body currently is at "Good Overall Status" (quality). Further details are provided in **Chapter 12: Water Resources and Flood Risk (ES Volume I - Application**

Document Ref. 6.2) (Section 12.4.10) and accompanying WFD Assessment (**Appendix 12B** (ES Volume II – **Application Document Ref. 6.3**)).

- 4.5.3 The bedrock geology (Mercia Mudstone Formation) is classified as a Secondary B aquifer. These are predominantly lower permeability layers which may store and yield limited amounts of groundwater due to localised features such as fissures, thin permeable horizons and weathering. These are generally the water-bearing parts of the former non-aquifers. Based on the WFD this groundwater body currently is at “Good Overall Status” (quality). Further details are provided in **Chapter 12: Water Resources and Flood Risk** (ES Volume I - **Application Document Ref. 6.2**) (Section 12.4.10) and accompanying WFD Assessment (**Appendix 12B** (ES Volume II – **Application Document Ref. 6.3**)).

Groundwater Vulnerability

- 4.5.4 The Environment Agency’s simplified Groundwater Vulnerability Map (Environment Agency 2017) shows that the Proposed Development Site is located in an area where the groundwater vulnerability to pollution is classified as medium-high. These are high priority groundwater resources that have limited natural protection. These areas are likely to be characterised by generally high leaching soils. This results in a medium-high overall pollution risk to groundwater from surface activities. Activities in these areas may require additional measures over and above good practice to ensure they do not cause groundwater pollution.

Groundwater Source Protection Zones

- 4.5.5 The Proposed Development Site does not lie within a Source Protection Zone (SPZ). There are no SPZ within 1km of the Proposed Development Site.

Groundwater Abstractions

- 4.5.6 According to the Envirocheck report, there is one licenced groundwater abstraction recorded within the Proposed Development Site and none within the extended 1km study area for groundwater abstractions. The abstraction point is indicated to be within the footprint of the existing Keadby Power Station (National Grid Reference 482619, 411656). It has multiple variations to the licence, with the most recent licensed to ‘*Siemens Public Limited Company*’ (Md/028/0083/040). The abstraction is listed as being for ‘*industrial/ commercial/ public services/ dewatering*’ and is related to the Keadby 2 Power Station (under construction).
- 4.5.7 Based on local authority consultation carried out, there are no records of private water abstractions within a 1km radius of the Proposed Development Site.

Groundwater Levels

4.5.8 Groundwater levels within the historical borehole records indicate generally shallow groundwater levels within the superficial geology of between 0.9m - 3.0m below ground level (bgl). Occasionally, deeper groundwater strikes were recorded between 5.4m - 6.9m bgl. There is insufficient information to conclude at this stage whether these levels are representative of true groundwater levels across the wider area. The Environment Agency does not hold any groundwater level monitoring data within a 1km radius from the Proposed Development Site boundary.

4.6 Hydrology

Surface Watercourses and Drainage

4.6.1 There are numerous surface water features located within the Proposed Development Site and wider study area. These are detailed, along with river quality information (where available) in Table 4.

Table 4: Surface water features

Surface water feature name	Location	River Quality Information
Various unnamed drains	Located on-site and within the study area; various directions.	Not available.
River Trent (tidal river) (Humber Upper)	Overlaps slightly onto the eastern spurs of the Proposed Development Site; north-south direction.	Reach: A631 Gainsborough To Keadby River Quality C Flow greater than 80 cumecs Year: 2000
Paupers Drain (includes Warping Drain and Eastoft Moors Drain) ² / Eastoft Moors (Warping) Drain (inland river) ³	Overlaps slightly onto the north-eastern spur of the Proposed Development Site; west-east direction.	Reach: Track Bridge to Confluence of River Trent River Quality D Flow less than 0.31 cumecs Year: 2000
Sewer Drain (drain)	Overlaps slightly onto the north-eastern spur of the Proposed	Not available.

² Source, Water Framework Directive (WFD)

³ Source, Envirocheck data

Surface water feature name	Location	River Quality Information
	Development Site; west-east direction.	
North Soak Drain (inland river)	Overlaps slightly onto the southern boundary of the Proposed Development Site and crosses the northern section of the A18 access road; west-east direction.	Reach: Medge Hall To Confluence of South Soak Drain River Quality E Flow less than 0.31 cumecs Year: 2000
Sheffield and South Yorkshire Navigation/ Stainforth and Keadby Canal (canal)	Overlaps slightly onto the southern boundary of the Proposed Development Site and crosses the northern section of the A18 access road; west-east direction.	Reach: Thorne Lock to Trent River Quality C Flow greater than 80 cumecs Year: 2000 Reach: River Don Navigation to Thorne Lock River Quality Chemistry General Quality Assessment (GQA) Grade A - Very Good Year: 2009 Reach: Thorne Lock to Trent River Quality Chemistry GQA Grade A - Very Good Year: 2009
South Soak Drain (inland river)	Crossed by the Construction and Operational Access Route and crosses the northern section of the A18 access road at its closest point; west-east direction.	Reach: Moors Bridge to Confluence of Three Rivers River Quality D Flow less than 0.31 cumecs Year: 2000
Torne/Three Rivers (includes South Engine Drain and Folly Drain) ⁴ / Three	100m south of the Waterborne Transport Off-loading Area at its closest point; south-west to north-east direction	Reach: Pilfrey Bridge to Keadby Pumping Station River Quality C Flow less than 1.25 cumecs Year: 2000

⁴ Source, WFD

Surface water feature name	Location	River Quality Information
Rivers (inland river) ⁵		Reach: Pilfrey Bridge to Keadby Pumping Station River Quality Chemistry GQA Grade D - Fair Year: 2009
Hatfield Waste Drain	Adjacent to the A18 junction and crossed by Mabey Bridge, to be replaced	Reach: Goodcop Farm to Pilfrey Bridge River Quality E Flow less than 1.25 cumecs Year: 2000
North Level Engine Drain	5m south of the A18 junction	Reach: Woodcarr Pumping Station to Pilfrey Bridge River Quality E Flow less than 0.31 cumecs Year: 2000
River Torne	20m south of the A18 junction	Reach: B1396 Rd Br Auckley To Pilfrey Bridge River Quality D Flow less than 1.25 cumecs Year: 2000
South Level Engine Drain	100m south of the A18 junction	Reach: Bull Hassocks Pump Station To Pilfrey Bridge River Quality D Flow less than 0.31 cumecs Year: 2000

- 4.6.2 Further information on the quality and status of relevant watercourses can be found in **Chapter 12: Water Resources and Flood Risk** (ES Volume I - **Application Document Ref. 6.2**) and **Appendix 12B: WFD Assessment** (ES Volume II - **Application Document Ref. 6.3**).

Surface Water Abstractions

- 4.6.3 Seven surface water abstractions have been identified within 250m of the Proposed Development Site. These are listed in Table 5.

Table 5: Environment Agency licensed surface water abstractions

⁵ Source, Envirocheck data

References (Figure 12.1 (ES Volume III - Application Document Ref. 6.4))	National Grid Reference	Approximate distance	Licence number and operator	Use
A5/6	483540, 411640	On the Proposed Development Site, located on the eastern extent of the eastern spur	03/28/85/0007 Keadby Generation Ltd	Production of energy: boiler feed; and Amenity: spray irrigation – direct
A13	481780, 412230	23m north-west	03/28/84/0008 Mr W Foster-Thornton	General agriculture: spray irrigation - direct
A7	482790, 411490	10m south	03/28/83/0171 Canal and River Trust/ British Waterways	Production of energy: boiler feed
A1	482790, 411490	10m south	Md/028/0083/014 Canal and River Trust	Mechanical non-electrical; evaporative cooling
A14	481800, 411400	160m south	03/28/83/0094 J A Chapman Farms	General agriculture: spray irrigation - direct
A15	483700, 411795	190m east	03/28/85/0006/1 Holly Hall Farms Ltd	Spray irrigation
A16	483700, 411795	190m east	03/28/85/0010 T F Belton Limited	General agriculture: spray irrigation - direct
A12	483171, 412204	230m north	Md/028/0084/005 RJ & AE Godfrey	General agriculture:

References (Figure 12.1 (ES Volume III - Application Document Ref. 6.4))	National Grid Reference	Approximate distance	Licence number and operator	Use
				spray irrigation - direct

Permit end dates for these abstractions are specified as 'not supplied', and therefore all are assumed to be active abstractions.

Nitrate Vulnerable Zones

4.6.4 The Proposed Development Site and the study area are located within a nitrate vulnerable zone – surface water. Designations of nitrate vulnerable zones occur where land drains contribute to nitrate concentrations found in polluted water. Polluted waters include:

- surface waters that contain at least 50mg/l of nitrate;
- surface waters that are likely to contain at least 50mg/l of nitrate if no action is taken; and
- waters which are eutrophic, or are likely to become eutrophic, if no action is taken.

Drinking Water Protected Areas

4.6.5 The Proposed Development Site and the study area are not located within a Drinking Water Protected Area (surface water).

4.7 Minerals Safeguarding and Mineral Extraction

4.7.1 The National Planning Policy Framework (NPPF) (Ministry of Housing, Planning & Local Government, 2019) for England requires minerals planning authorities to promote sustainable use of mineral resources in their Local Plans. North Lincolnshire Council is the local authority responsible for minerals planning in Keadby.

4.7.2 The adopted 2003 Local North Lincolnshire Plan does not refer to any minerals safeguarding or consultation areas in the study area. The 2003 Local North Lincolnshire Plan is due to be replaced by the North Lincolnshire Local Plan which will run to 2037. This is currently at Preferred Options Consultation stage.

4.7.3 Based on available data and local authority consultation carried out there are no records of aggregate/ mineral quarrying or mining, non-coal mining or coal mining within 500m of the study area of the Proposed Development Site.

4.7.4 As such, the risk from quarrying and mining can be considered negligible.

4.8 Radon

4.8.1 The Envirocheck report and the Public Health England (PHE) Radon UK map indicate that the Proposed Development Site is within an area where the risk from radon is generally considered to be low. Less than 1% of homes are above the UK 'Action Level'.

4.8.2 No radon protective measures are necessary (applicable in the construction of new dwellings or extensions.)

4.9 Unexploded Ordnance

4.9.1 According to the Zetica website (2020), the Proposed Development Site lies within a zone that experiences a low risk of UXO.

4.9.2 The Preliminary UXO Threat Assessment provided by 6 Alpha Associates indicates that the potential for encountering UXO at the site is 'unlikely'. This report is presented in **Annex C**.

4.10 Utilities

4.10.1 Utility plans are included in **Annex D**. The confirmed utilities at the location of the Proposed PCC Site are summarised in Table 6 below.

Table 6: Summary of indicated services.

Utility Type	Utility Company	Location
Telecoms	Open Reach	Open Reach line and boxes to the east of the site. Open Reach line also runs parallel to the track to the south of the site.
Power	Northern Power Grid	Underground conductor runs east-west along the boundary separating the northern and southern sections of the site. Overhead conductor runs parallel to the track to the south of the site. Underground conductor cuts across and runs parallel to the track to the south of the site.
Water	Yorkshire Water	None shown within the site.
Gas	Cadent	Gas pipe cuts across and runs parallel to the track to the south of the site.

4.10.2 Utility data for the A18 junction has also been sourced to inform the design of the carriageway improvement proposals (**Application Document Ref. 4.6**),

including replacement Mabey Bridge (**Application Document Ref. 4.16**). This is included for completeness in **Annex D**.

5.0 REGULATED ACTIVITIES

5.1 Introduction

- 5.1.1 The key relevant features that characterise the Proposed Development Site and surrounding area are summarised in this section, along with an indication of the risk to land quality of the Proposed Development Site. Information detailed in the following section has been taken from the Landmark Information Group Envirocheck Report obtained for the Proposed Development Site.
- 5.1.2 Information on groundwater and surface water abstractions is detailed in Section 4.5 and 4.6 and is not repeated here.
- 5.1.3 Generally, any regulated processes, registered radioactive substances, licensed waste management facilities and landfills, hazardous substances, fuel station entries and any other contemporary trade directory entries within 250m of the Proposed Development Site could, depending upon the nature of their activities represent potential sources of contamination.

5.2 Regulated Processes

- 5.2.1 Table 7 summarises information on regulated processes which has been collated from Environment Agency and Local Authority datasets presented within the Landmark Information Group GIS data.

Table 7: Summary of regulatory information – industrial processes

Consent	Number present in relation to Proposed Development Site		Details
	On-site	0-250m	
Discharge Consents	9	14	<p><u>On-site:</u> Various locations, concerning sewage/ trade effluent/ trade discharge (process water) to underground strata/ surface water/ unknown (receiving water not supplied)</p> <p><u>Off-site:</u> Various locations, concerning sewage/ trade effluent/ contaminated water/ trade discharge (process water and cooling water) to underground strata/ surface water/ unknown (receiving water not supplied)</p>

Consent	Number present in relation to Proposed Development Site		Details
	On-site	0-250m	
Integrated Pollution Controls	1	11	<p><u>On-site:</u> Located within the footprint of the Additional Abnormal Indivisible Load Route.</p> <p><u>Off-site:</u> All located within the footprint of the current Keadby Power Station (adjacent). Name: Keadby Generation Limited Concerning combustion processes within the Fuel & Power Industry Status: Authorisation superseded by a substantial or non substantial variation (11 no.) and revoked (1 no.)</p>
Integrated Pollution Prevention and Control	7	6	<p><u>On-site and off-site (adjacent):</u> All located within the footprint of the current Keadby 1 Power Station.</p> <p>Name: Keadby Generation Limited Concerns combustion; any fuel greater or equal to 50Mw and gasification, liquefaction and refining; odourising natural gas/ LPG Status: Valid (2 no.), superseded by variation (7 no.), effective (1 no.)</p> <p>Name: National Grid Gas plc Concerns gasification, liquefaction and refining; odourising natural gas/ LPG Status: Valid (2 no.), effective (1 no.)</p>
Local Authority Pollution Prevention and Controls	0	4	<p><u>Off-site:</u> 20m south, located within the footprint of the current Keadby 1 Power Station Type: air pollution control Process: PG1/15 Odourising natural gas and liquified petroleum gas Status: authorised 30m south-west of the Waterborne Transport Off-Loading Area</p>

Consent	Number present in relation to Proposed Development Site		Details
	On-site	0-250m	
			<p>Type: air pollution control Process: PG3/5 Coal, coke and coal product processes Status: authorised</p> <p>20m south of the Additional Abnormal Indivisible Load Route Type: Local Authority Pollution Prevention and Control Process: PG3/5 Coal, coke and coal product processes Status: permitted</p> <p>215m south-east of the Waterborne Transport Off-Loading Area Type: air pollution control Process: PG3/5 Coal, coke and coal product processes Status: authorised</p>

5.3 Waste Management Facilities

5.3.1 Table 8 summarises information on licensed and historical waste management facilities collated from the Environment Agency and Local Authority datasets presented within the Landmark Information Group GIS data.

Table 8: Summary of regulatory information – waste management processes

Subject	Number present in relation to Proposed Development Site		Details
	On-site	0-250m	
Landfill Sites	4	4	<p><u>On-site:</u></p> <p><i>BGS recorded landfill site and historical landfill site;</i></p> <p>Keadby Power Station landfill located in the northern area of the Proposed Development Site and extends beyond the Proposed Development Site boundary to the west. Operated by the Central Electricity Generating Board with the first waste input recorded in 1958. Identified as having received inert and industrial waste.</p> <p><i>Historical landfill site;</i></p> <p>Keadby Central Electricity Generating Board slightly overlaps into the south-western boundary of the Proposed Development Site, and licensed between 1977 and 1990, but with the first recorded input to have been in 1958 and last input in 1990. This landfill is indicated to have received inert, commercial, industrial and household waste. Also, know to have received Ash (from Keadby Power Station after lagoon settlement), construction, colliery tailings, refractories (from Keadby Power Station) and asbestos.</p> <p><i>Licensed waste management facility and historical landfill site:</i></p> <p>Keadby Power Station landfill slightly overlaps into the south-western boundary of the Proposed Development Site and licensed in 1992. First recorded input in 1992 and last recorded input in 1993. This landfill is indicated to have received inert, commercial and</p>

Subject	Number present in relation to Proposed Development Site		Details
	On-site	0-250m	
			<p>household waste. Construction, demolition wastes of an inert nature only, comprising brick and concrete rubble arising from the demolition of Keadby Power Station.</p> <p>Operated by Keadby Power Ltd. Maximum input: Medium (equal to or greater than 25,000 and less than 75,000 tonnes per year). Status: inactive.</p> <p><i>Registered landfill site and historical landfill site;</i></p> <p>Transtore Industries/ Former Keadby Power Station landfill slightly overlaps into the south-western boundary of the Proposed Development Site. Operated by the Central Electricity Generating Board, licensed from 1987 but received date of waste was from 1981. No indicated surrender dates. This landfill is indicated to have received inert, industrial, commercial, household and special waste. Maximum input: Very Small (less than 10,000 tonnes per year). Status: licence cancelled.</p> <p><u>Off-site:</u></p> <p><i>Historical landfill site;</i></p> <p>Keadby Power Landfill located in the central part of the Keadby 1 Power Station, 15m from the Proposed Development Site, and licensed between 1992 and 2000. Reported to have received inert and industrial waste.</p> <p><i>Licensed waste management facility and historical landfill site:</i></p> <p>John Brown Engineering landfill located 15m west of the Proposed Development Site at its</p>

Subject	Number present in relation to Proposed Development Site		Details
	On-site	0-250m	
			<p>closest point. Licensed between 1994 and 2000, but with the first input in 1994 and the last input recorded in 1995. This landfill is indicated to have received inert, industrial and liquid sludge waste. Operated by J Brown Engineering Ltd. Maximum input: Large (equal to or greater than 75,000 tonnes per year). Status: inactive.</p> <p><i>Historical landfill site;</i> Pulverised Fuel Ash (PFA) Settlement Lagoon, Keadby Power Station, located to the east of the Keadby Power Station landfill and 45m west of the Proposed Development Site at its closest point. Operated by the Central Electricity Generating Board with no recorded licence details.</p> <p><i>Historical landfill site;</i> Keadby Power Station landfill located to the west of the PFA settlement lagoon and 80m west of the Proposed Development Site at its closest point. Operated by the John Brown Engineering. No licence or waste details indicated.</p>

5.4 Hazardous Substances

- 5.4.1 There is one Planning Hazardous Substances Consent located within the study area. This is located 40m south of the Additional Abnormal Indivisible Load Route and it concerns ammonium nitrate-based fertilisers which conforms to the Fertilisers Regulations 1991(a) and composite fertilisers containing phosphate and/or potash. However, its status is indicated to have been withdrawn.
- 5.4.2 There are no Registered Radioactive Substances listed on the Proposed Development Site or in the study area.

5.4.3 There are no records of COMAH (Control of Major Accidents Hazards) sites or licenses present on the Proposed Development Site or within the study area.

5.4.4 There are four historical tanks indicated on available plans within the Proposed Development Site; three above ground oil storage tanks located within the footprint of the existing Keadby Power Station (which currently forms part of the Keadby 2 Power Station construction site) and one located on the eastern spur (the Water Connection Corridor) which is assumed to be associated with the pumping station. There is one historical tank located 220m south of the Abnormal Indivisible Load Route.

5.5 Contemporary Trade Directory Entries

5.5.1 There is one contemporary trade directory entry located within the Keadby 1 Power Station footprint, adjacent to the Proposed Development Site for the Applicant and electricity generation. There are two further trade directory entries within the study area; one active entry located 40m south of the Additional Abnormal Indivisible Load Route for PD Ports and one inactive entry located 200m north and south-east of the Water Connection Corridor for SL Cleaning Services.

5.6 Pollution Incidents

5.6.1 There is one recorded pollution incident to controlled waters (Category 3) listed for the Proposed Development Site. This is indicated to have been at the eastern extent of the Water Connection Corridor and concerned raw sewage in filter pipes which impacted an abstraction. The receiving water was identified as a saline estuary (River Trent) and the incident occurred in 1999.

5.6.2 There are a further four Category 3 pollution incidents to controlled waters within the study area. The closest of these was 10m north of the Waterborne Transport Off-Loading Area and concerned oil pollutants to an unknown receiving water in 1996. Of the remaining three incidents, these are either older than 30 years or in excess of 100m from the Proposed Development Site.

5.7 Sensitive Land Uses

5.7.1 Sensitive land uses on the Proposed Development Site and within the study area are summarised in Table 9.

Table 9: Summary of sensitive land uses

Sensitive land use	Distance and direction from the Proposed Development Site	Details
Ramsar Site – Humber Estuary	On-site (eastern extent of the proposed Water Connection	Status: listed

Sensitive land use	Distance and direction from the Proposed Development Site	Details
Site of Special Scientific Interest (SSSI) – Humber Estuary	Corridors) and beyond the Proposed Development Site boundary to the east	Status: notified
Special Area of Conservation (SAC) – Humber Estuary		Status: designated
Local Wildlife Site (LWS) – Keadby Boundary Drain	Adjacent to the north-west boundary of the Proposed Development Site	Type: non-statutory Status: selected LWS
LWS – Stainforth and Keadby Canal Corridor	On-site (very slight overlap onto southern boundary (Potential Abstraction Option) and beyond the Proposed Development Site boundary to the south	Type: non-statutory Status: selected LWS
LWS – South Soak Drain, Keadby	25m south of the Proposed Development Site	Type: non-statutory Status: selected LWS
LWS – Keadby Wetland	25m south of the Proposed Development Site	Type: non-statutory Status: selected LWS
LWS – Keadby Wet Grassland	50m south of the Proposed Development Site	Type: non-statutory Status: selected LWS
LWS – Three Rivers	100m south of the Proposed Development Site	Type: non-statutory Status: selected LWS
LWS – Keadby Warping Drain	On-site (north-eastern spur of Water Connection Corridor) and beyond the Proposed Development Site boundary to the north	Type: non-statutory Status: selected LWS
LWS – Hatfield Waste Drain	On-site (A18 junction)	Type: non-statutory Status: selected LWS
LWS – North Engine Drain, Belton	1m south of A18 junction	Type: non-statutory Status: selected LWS

Sensitive land use	Distance and direction from the Proposed Development Site	Details
LWS – River Torne	25m south of the A18 junction	Type: non-statutory Status: selected LWS
LWS –South Engine Drain, Belton	110m south of the A18 junction	Type: non-statutory Status: selected LWS

6.0 HISTORICAL DEVELOPMENT

6.1 Introduction

6.1.1 Historical mapping has been reviewed to evaluate the potential for past activities, both on and adjacent to the Proposed Development Site, to have impacted upon the its environmental and land quality. Historical Ordnance Survey (OS) maps of the Proposed Development Site were obtained from the Landmark Information Group and are presented in **Annex B**. The available mapping dates were between 1885 - 2020. Where dates are given in the text, these refer to dates of maps on which the features appear, and do not necessarily refer to exact dates of construction, or operation of any particular facility.

6.2 Proposed Development Site

6.2.1 Circa 1885 – 1886, the Proposed Development Site is shown to be largely undeveloped with predominantly open fields, forming Keadby Common at the centre. Properties are present on the eastern-most spur of the Proposed Development Site, near to the western banks of the River Trent. A railway passes just over the southern boundary near to Keadby Junction. This railway runs broadly parallel adjacent to the south of the Proposed Development Site in a west-east direction.

6.2.2 No notable changes occurred until around 1967 – 1969 when a power station is shown to have been developed in the central/ eastern area. The mapping shows electricity transmission cables and pylons originating from the power station and spanning across the centre. Railway lines, orientated in a west-east direction, occupy the south-western area which lead to, and terminate, at the power station. Adjacent to the north of the railway lines is a conveyor system, presumably used for the transport of materials and fuels, such as coal, from trains to the power station. An area of marshland is present in the south-west along with a small refuse heap, with tracks leading from this to the power station and also extending beyond the site boundaries. Three mixed circular and rectangular tanks of unknown contents are present south and east of the power station. Keadby Common Farm is also present at the centre along with a wider network of drains. To the east, an increase in properties is noted. A pond and a tank are also present on the eastern-most spur of the Proposed Development Site.

6.2.3 By 1978 – 1982, circa seven mixed circular and rectangular tanks are shown to occupy the land directly south of the main power station building.

6.2.4 No notable changes occur until 1991 – 1994, at which time the power station is labelled as disused. Contained within the Proposed Development Site boundary in the east are jetties present on the River Trent, with a pumping station located inland where the pond and tanks are located. Keadby Common Farm is no longer shown.

6.2.5 From 1995 onwards, the disused power station has become an electric generation station and a change in site layout is observed. The railway and conveyor system that was previously present terminating at the power station is now absent from the landscape. A set of small tanks and a single tank is located to the west; five tanks run parallel to the south, and an additional set of tanks is located east of the electric generation station. Further west from the electric generation station, towards the centre of the Proposed Development Site, are three large tanks. The refuse heap and area of marshland to the south-west of the Proposed Development Site are now indicated to be absent. A large electric substation is now present in the north of the Proposed Development Site with electricity transmission cables and pylons connected to the electric generation station, with overhead cables leading off-site to the north, south and west. A building and mast are present to the north of the electric generation station.

6.2.6 Aerial imagery from 2003, 2008 and 2015 demonstrate no notable changes.

6.3 Study Area

6.3.1 From 1886, a railway line runs parallel and adjacent to the south of the Proposed Development Site with areas of marshland beyond this approximately 50m away from the boundary. Towards the River Trent, to the south of the Proposed Development Site boundary, is a gasometer approximately 60m away, which is absent from mapping in 1907. Occasional farms and farmland are located within the study area.

6.3.2 No additional notable features with a potential to have resulted in land contamination are noted until around 1966 – 1969. At this time and 220m west of the Proposed Development Site, a large slag heap with two sludge beds and a pond are indicated. A drain is also present adjacent to the slag heap and pond, which appears to be connected to one of the sludge beds and indicated to run onto the Proposed Development Site, passing through the centre. An additional drain is also present north of the slag heap that passes past the northern boundary of the Proposed Development Site, with a drain adjacent to the south of the slag heap which runs onto the Proposed Development Site. To the east, adjacent to the Proposed Development Site, a coal wharf is present on the banks of the River Trent, with a loading bay on train tracks further inland approximately 30m from the Proposed Development Site. An electrical substation is present in the loading bay. A pond is located adjacent to the south of the loading bay. Further south and to the east is a depot approximately 120m south, along with a set of tanks present approximately 220m from the Proposed Development Site.

6.3.3 Mapping from 1994 shows that the loading bay and associated railway previously mentioned to the south-east of the Proposed Development Site are now absent from the landscape, with the pond now assumed to have been infilled. A warehouse is now also present in the location of the former loading bay approximately 20m from the Proposed Development Site.

- 6.3.4 Historical maps from 1995 show the slag heap to the west of the Proposed Development Site as a disused spoil heap. The two sludge beds, pond and drains associated with this area are no longer apparent and are assumed to have been infilled.
- 6.3.5 No other notable off site historical contaminative features are evident from recent mapping and aerial imagery.

6.4 A18 Access Road and Study Area

- 6.4.1 Historical maps from the National Library of Scotland dated 1885, 1905 – 1906 and 1948 indicate that the location of the proposed access road from the A18 and the potential laydown options in adjacent agricultural fields were agricultural fields during this time period. Recent historical maps viewed on Google Earth Pro indicate that this area has been agricultural land and a track since 2002. On these maps, North Pilfrey Farm and Pilfrey Farm have been present since 1885. These are located approximately 100m north of the northern extent of the proposed A18 access road, and approximately 200m east of the southern extent of the proposed A18 access road, respectively.

7.0 PREVIOUS GROUND INVESTIGATIONS

7.1 Introduction

7.1.1 This section summarises a number of previous reports that have been made available to AECOM, relating to the Proposed Development Site. These have been summarised in chronological order (from the most recent to the oldest).

7.1.2 Trent and Peak Archaeology (2021) A geoarchaeological hand auger survey at Keadby 3 Low Carbon Gas Power Station, Lincolnshire and Magnitude Surveys (2021) Geophysical Survey Report for Keadby, North Lincolnshire

Introduction

7.1.3 The geoarchaeological hand auger survey was undertaken to determine the possible presence of peat across the Proposed Development Site.

Summary of Key Information

7.1.4 Paragraph 4.7.3 of **Appendix 15A**: the Cultural Heritage Desk Based Assessment (ES Volume II - **Application Document Ref. 6.3**) concludes from these reports that although a historical landfill is recorded within the Proposed PCC Site towards the north of the Proposed Development Site. Following the completion of the geoarchaeological hand-auger survey within the Proposed PCC Site, no evidence for below ground landfill was identified. This suggests that the landfill may have been above ground.

7.1.5 As the purpose of this survey was not to ascertain the potential sources of contamination, no regard has been given to this data in this report or in **Chapter 13: Geology, Hydrogeology and Land Contamination** (ES Volume I - **Application Document Ref. 6.2**).

7.2 URS (2018) Design of a Site Protection and Monitoring Programme for Keadby Generation Ltd, Keadby Power Station

Introduction

7.2.1 This report represented the Site Protection and Monitoring Programme (SPMP) for Keadby Power Station submitted to the Environment Agency in pursuance of Condition 2.8.1 of the Permit No. (YP3133LL), authorising the operation of the Keadby Power Station Installation. The SPMP was a revised and updated version of the original SPMP that was submitted in 2007 incorporating identified changes to the infrastructure monitoring protocols and any potential polluting events that had occurred on the site.

Summary of Key Information

7.2.2 An issue regarding the integrity of drainage in the south eastern corner of the site was raised in an Application Site Report (ASR) submitted as part of the IPPC application. Due to subsidence, the drains in the area had been

inspected by a third party and damage to the drains had been identified. As stated in the ASR the drainage system in this area had been dug out and a new drainage system had been laid. These improvements were made in March 2006, prior to issue of the PPC permit. The survey report from work carried out in 2006 was forwarded to the Environment Agency. A formal programme of ongoing, three yearly integrity inspections of the drainage system across the whole of the site had been implemented.

- 7.2.3 An extensive programme of drain cleaning and camera inspections of site drainage was carried out in 2017. Some minor repairs were conducted. Further inspections were carried out in 2018.
- 7.2.4 On 16th October 2007, the Environment Agency were notified of gas oil that was identified during an excavation on the distillate oil tank farm. The Environment Agency subsequently acknowledged that the oil spill was of a low level and had occurred historically. The Environment Agency deemed that this historic oil spill was not relevant to the operation of the site at the time and should be referenced in, but not monitored through, the SPMP.
- 7.2.5 Following the oil spill identification, several monitoring points were installed, and monitoring was conducted, to further assess the historical oil spill. Following discussions with URS, it was identified that new monitoring boreholes should be installed to provide a greater representation of conditions at the site. Free product was not identified in any of the monitoring wells during a groundwater monitoring event in January 2013.
- 7.2.6 The SPMP did not cover environmental monitoring or the collection of reference data, as this was determined as unnecessary through the assessment of the Keadby Power Station installation and its activities using the Environment Agency's H7 Guidance document. For all relevant activities at the installation it was considered that there was little likelihood that land pollution or leaks to the land would occur during the future life of the installation. It was stated that monitoring of the historical gas oil spill would continue with results reported to the Environment Agency but outside of the scope of the SPMP.

Reports Contained within the Appendices of the SPMP

- 7.2.7 Previous reports were included within the appendices of the SPMP; however, these did not appear to be summarised in the main report. These included;
- Exploration Associates Ltd 1992. Keadby Power Station: Site Contamination Assessment;
 - Exploration Associates Ltd 1992. Keadby Power Station, Factual Report on Ground Investigation;
 - Environmental Resources Management 2017. Project Keadby Power Station: Phase 1 Desk Study Report; and

- Environmental Resources Management 2017. Phase II Baseline Investigation Keadby.

7.2.8 The Exploration Associates Ltd reports above were summarised in the Environmental Resources Management (ERM) 2016 Environmental Statement (see Section 7.7) and therefore are not discussed further in this section.

7.2.9 The ERM 2017 reports are summarised in Sections 7.5 and 7.6.

7.3 Structural Soils (2017) Keadby Power Station, Geo-environmental Report

Introduction

7.3.1 The purpose of this report was to investigate ground conditions and provide information on land contamination, both to assess risks to human health and groundwater, prior to construction of Keadby 2 Power Station (adjacent to Keadby 1).

Risks to Human Health

7.3.2 With the exception of the presence of asbestos, the Structural Soils assessment indicated contaminant concentrations in the soil were below the RSK assessment criteria used (commercial end use). Therefore, Structural Soils concluded that the risks to site users (other than from asbestos) was low to very low.

7.3.3 It was concluded that the presence of asbestos would lead to a moderate to low risk during the construction phase, but that this risk could be managed.

Risks to Groundwater

7.3.4 The Structural Soils investigation identified marginally elevated levels of contaminants in two of the leachate samples which they stated may pose a risk to the underlying Secondary A aquifer. Also, elevated total petroleum hydrocarbons (TPH) was recorded in the water sample taken whilst drilling from one exploratory hole. However, no corresponding elevated concentrations were recorded in the groundwater samples obtained from the wells following purging and as such, Structural Soils presumed that there was no pathway and that increased hard standing would limit the pathway further.

Remediation

7.3.5 The minimum remediation required for the site was assumed to be the removal of the buried foundations and other areas of hardstanding. Due to the presence of asbestos within the soil, although low, asbestos management would be required during the construction works.

- 7.3.6 Structural Soils also conclude that localised areas of contamination are likely to be at the site given the history of the site and existence of Made Ground, Structural Soils recommended to maintain vigilance during site clearance and construction, in case any further areas of suspected contamination were encountered. It was recommended that if further areas of contamination were encountered, then a suitably qualified person should undertake appropriate sampling, testing and further risk assessment.

Ground Gas

- 7.3.7 Following gas monitoring on three occasions, a Gas Characteristic Situation 1 (very low hazard potential) was defined.

7.4 Environmental Resources Management (2017) Project Keadby Power Station: Phase 1 Desk Study Report

Introduction

- 7.4.1 ERM was commissioned by Scottish and Southern Electricity (SSE) ('the client') to undertake a Phase I Environmental Site Assessment (ESA) of the Proposed Development (Keadby 2), Trentside, Keadby, Scunthorpe DN17 3EF.
- 7.4.2 A number of previous reports (approximately 20) had been made available to ERM and had been reviewed and summarised in the report. This included site investigation data dating from 1991 to 2016 and were used by ERM to provide details on the potential sources of contamination at the Proposed Development Site. ERM provided an overall summary of the findings of these 20 documents. This is provided in this section, below. However, a more detailed review of some of these reports (those that have been made available to AECOM) has been provided in Sections 7.7 to 7.11, and 7.14.

Summary of Potential Current On-site and Off-site Sources of Impact

- 7.4.3 The large areas to the north-west of Keadby 2 were identified to be dominated by landfills of various compositions and were considered to be a potential significant source of contamination. The nature of the wastes are likely to comprise ashes, sludges and builders wastes. Therefore, it was considered that the potential for the generation of large volumes of ground gas and leachate are likely to be limited.
- 7.4.4 Made Ground, including PFA and Blast Furnace Slag (BFS) were reported to cover much of Keadby 2 and a large area to the west of Keadby 2. The PFA and BFS were reported to be associated with high concentrations of sodium, sulphate and boron as well as potentially having a high alkalinity (frequently demonstrated to be above pH 10). The previous site investigations reviewed by ERM had mentioned the presence of asbestos in the Made Ground, although ERM indicated that only low concentrations were present.

- 7.4.5 The tanks associated with the current Keadby Power Station were considered potential sources of hydrocarbon impact. ERM indicated that some contamination was noted in a URS 2012 report and anecdotal evidence indicated that some floating product was present on the perched groundwater, although the lateral extent was limited. This is discussed further in Section 7.11.
- 7.4.6 The potential source of PCB associated with the electricity substation to the north of Keadby 2 was considered to be a source of potential impact due to its size. Analysis of PCB was completed by Exploration Associates in 1992, but significant concentrations of PCB in soils were not detected. Many of the samples were taken across the site with some more targeted in close proximity to the electrical substation.
- 7.4.7 The historical coal power station and its associated railway sidings were considered to be potential sources of contamination. The presence of heavy metals and phenols are associated with clinker, coal slag and coal tars as well as with areas of coal storage. Some isolated hotspots of heavy metals and some hydrocarbons had been detected in close proximity to the footprint of the former coal fired power station.

Summary of Recommendations Made

- 7.4.8 The following recommendations were made:
- Undertake a site investigation specifically focussing on the potential for contamination in the shallow soils and groundwater. It was recommended that this would comprise the use of boreholes to depths of 5m bgl and monitoring of these and the existing monitoring wells on site;
 - Adopt field screening using a photo-ionisation detector to discount the potential for volatile organic compounds (VOC) contamination;
 - Delineate areas of potential concern such as areas of known hydrocarbon impact to determine options for treatment of the groundwater, if required, but also removal/ disposal/ remediation of any soil hotspots which could be excavated;
 - Undertake an investigation of the areas containing slag and the high pH in groundwater. This could be a combination of shallow boreholes and hand excavated pits to depths of 1.5m bgl. The aim of this assessment would be to consider options to treat groundwater during the temporary works/ enabling works, but also to assess options to retain and reuse the slag on site or characterise the materials for offsite disposal; and
 - Complete shallow ground gas monitoring to assess the requirement for impermeable ground gas membranes beneath the building footprint.

7.5 Environmental Resources Management (2017) Phase II Baseline Investigation Keadby

Summary of Phase 2 Investigation

- 7.5.1 The Phase 1 study summarised in Section 7.5, identified several potential data gaps, following a review of available site investigation information. A Phase 2 site investigation was therefore commissioned within the Keadby 2 area, to address the data gaps.
- 7.5.2 The Phase 2 site investigation was undertaken between 31st July and 3rd August 2017. The investigation comprised the advancement of seven windowless sample boreholes, hand digging of four soil bores, the collection of soil and groundwater samples for chemical analysis and completion of two rounds of soil gas monitoring. The boreholes reached maximum depths of 2.0m bgl.
- 7.5.3 Some visual or olfactory evidence of contamination was observed in the soil during the fieldwork activities; white precipitate was observed in four locations within the Made Ground between depths of 0.4 and 1.15m bgl and natural black staining was observed in two locations within clay between depths of 1.2 and 1.3m bgl.
- 7.5.4 Limited visual or olfactory evidence of contamination was observed in the groundwater during fieldwork activities. A yellow green 'scummy' film was observed on the surface of a grab sample in one location, where groundwater had collected above the refusal depth.

Ground Conditions

- 7.5.5 The shallow ground investigation encountered Made Ground, which was mainly composed of clinker or BFS. This was underlain by soft to firm clay. Additionally, fibrous peat was encountered to the west of the site. The clay was underlain by a well sorted sand in the east.

Human Health Risk Assessment

- 7.5.6 In terms of human health impacts from the soils, the ERM assessment recorded no exceedances of the GAC under a commercial land use scenario. Based on this, ERM stated that no risks were predicted to human health, assuming ongoing commercial use of the site and appropriate precautionary measures such as Personal Protective Equipment (PPE) to be adopted during construction.

Asbestos Assessment

- 7.5.7 Asbestos was detected in five of seven soil samples analysed, from locations distributed across the site, all within a depth of between 0.1 and 0.4m bgl. Quantification analysis was completed, the results of which identified that asbestos was present at concentrations less than <0.001%. The

concentrations were detected below the method detection limits and whilst a positive result was returned in the screening exercise, the quantification had returned results that were not considered by ERM to pose a potential risk to human health. Therefore, no special precautions were considered to be required during the earthworks.

- 7.5.8 However, the potential for asbestos to be encountered during excavation works could not be discounted and it was therefore recommended that a watching brief should be adopted during construction works. It was also recommended that the Contractor develop an asbestos management plan in the event that hotspots of suspected ACM were encountered.

Controlled Waters Risk Assessment

- 7.5.9 The River Trent (775m east of the Keadby 2 site) had been identified as a controlled waters receptor and considered in the generic risk assessment. Therefore, groundwater results were compared against Fresh Water Environmental Quality Standards (EQS).

- 7.5.10 Groundwater was present within each of the seven monitoring wells and a groundwater sample was obtained from each location. The depth to groundwater was measured, which identified potential groundwater flow towards the north. It was indicated that the groundwater encountered during the investigation works was perched groundwater present within the sand lenses of the underlying clay and upper Made Ground layer. Further evidence that the shallow groundwater encountered was perched and not a continuous water body was that during the monitoring works the wells were purged with little recharge being observed.

- 7.5.11 Comparing the results from the groundwater analysis with the Freshwater EQS assessment criteria, ERM concluded that barium and boron were the only criteria which were exceeded within all of the seven groundwater samples. This was considered by ERM as potentially representative of natural background concentrations. Elevated sulphate concentrations were recorded within all but one of the samples analysed, which was attributed to the former use of the site and widespread deposition of PFA. Overall, ERM suggested that the shallow groundwater test results indicated the risks to the controlled water receptor associated with a potential groundwater source were low.

Soil Gas Risk Assessment

- 7.5.12 Based on the available monitoring results, it was considered by ERM that the risk to the on-site and off-site receptors via gas migration pathways from the Keadby 2 site was very low.

Waste Classification

- 7.5.13 ERM completed a waste classification assessment based on five soil samples recovered from five boreholes across the Keadby 2 site. Each of the five samples were classified by ERM as non-hazardous. It was further concluded

that whilst the soil concentrations were low, given that the material was Made Ground, it was considered unlikely that the material could be classified as Inert.

- 7.5.14 The interpretation presented in the report offered a steer in relation to the proposed construction works and was based on a limited number of samples. It was considered possible that hotspots of material may be present at the Keadby 2 site that could be classified as hazardous waste if excavated with an intention to discard. Therefore, recommended that a watching brief be adopted during the construction works to allow for the segregation of those materials that could be considered to be hazardous. It was recommended that method statements in relation to this process should be presented in a Materials Management Plan.

7.6 Environmental Resources Management (2016) Keadby 2 Power Station Environmental Statement

Introduction

- 7.6.1 An ES was prepared in 2016 by ERM for the Keadby 2 Power Station, which is located approximately in the centre of the Proposed Development Site (see **Figure 13A.3** - Proposed Development Layout (ES Volume II – **Application Document Ref. 6.3**).
- 7.6.2 Previous intrusive site investigations of the Keadby 1 and Keadby 2 Power Station areas (as part of the pre-construction activity for Keadby 2 Power Station) were summarised in the ERM Keadby 2 ES. These included:
- Wimtec Environmental Ltd 1998. Scottish Hydro Electric Plc, Keadby 2 CCGT Development, Report on Ground Investigation (reference 1);
 - Exploration Associates Ltd 1992. Keadby Power Station: Site Contamination Assessment (reference 2);
 - Exploration Associates Ltd 1992. Keadby Power Station, Factual Report on Ground Investigation (reference 3); and
 - Mott MacDonald 1991. Project Phoenix, Keadby Power Station, Phase 1 Site Investigation Interpretative Report (reference 4).
- 7.6.3 These four reports summarised as part of the ERM Keadby 2 ES report are therefore not included as independent reviews but do form part of this ERM Keadby 2 ES report review detailed below.

Summary of Ground Conditions Encountered

- 7.6.4 The previous intrusive investigations characterised the geology underlying the eastern and western sections of the Keadby 2 Power Station; indicating Made Ground overlying Alluvium, which in turn overlies bedrock comprising Mercia Mudstone.

- 7.6.5 The Made Ground was described as compact to very compact, stratified sand and silt, PFA with occasional concrete rubble, coarse gravel, cobbles of brick, steel fragments, timber, glass, slag and furnace clinker (foundry waste). The Made Ground was found to be on average 2m thick, though this could vary across the Keadby 2 Power Station site between 0.2m and 3m thickness. The various artificial fragments were considered likely to have been derived from the previous coal fired power station activities.
- 7.6.6 The superficial deposits beneath the Made Ground comprised Alluvium associated with the River Trent. The Alluvium was classified as 'Upper Drift' and 'Old River Sand'. The Upper Drift comprised loose and medium-dense, medium grained sands with soft and firm silt and clays. Soft peat clay or peat deposits were locally present within the upper limits of the unit, particularly in eastern sections where they were up to 3.7m in thickness. The general thickness of this unit was approximately 5m however this extended to over 8m in areas. The Old River Sand (Granular Alluvium) comprised medium-dense to dense, medium-grained silty sand, encountered at approximately 7.5 – 8m bgl. The total thickness of the unit was approximately 7m, with a coarse-grained sand base.
- 7.6.7 The Mercia Mudstone underlying the superficial deposits was divided into a weathered unit and the bedrock unit. The weathered unit included the upper part of the bedrock up to 5m in thickness and was recovered as silty clay with occasional thin bands of mudstone. The Mercia Mudstone bedrock was encountered between 19 – 30m bgl, which was composed of thinly laminated mudstone with subordinate siltstone and occasional gypsum veins (up to 5mm thick).

[ERM's Screening of Soil Contamination Results from Previous Ground Investigations](#)

- 7.6.8 Previous ground investigations (references 1 and 2) provided baseline soil quality data. As part of a site-wide investigation, Wimtec (1998) provided data from 10 boreholes and 10 trial pits, whilst Exploration Associates (1992) advanced 4 boreholes and 31 trial pits across the Keadby 2 Power Station and areas immediately to the east (within the existing Keadby 1 Power Station).
- 7.6.9 The Keadby 2 ES reported on screening for a range of heavy metals, polycyclic aromatic hydrocarbons (PAH) and other organic material concentrations recorded during these previous investigations against ERM's adopted General Assessment Criteria (GAC) for commercial end use.
- 7.6.10 It was summarised that the baseline soil metal concentrations recorded during the previous investigations were typical of natural levels found within agricultural soils, and in general, were significantly below the adopted GAC values for a commercial end-use environment. There was one recorded exceedance from the Wimtec (1998) samples, for chromium (418 mg/kg versus the GAC value of 330 mg/kg), as well as some elevated concentrations of lead, up to 4,620 mg/kg. The location of the chromium exceedance was

from a trial pit Made Ground sample, in the south-east corner of the eastern part of Keadby 2 Power Station. This isolated and limited exceedance was not considered significant by ERM given the number and range of analyses reported within the GAC. Two samples were also submitted for PAH analysis during the Wimtec (1998) investigation, with no exceedances of the GAC identified.

ERM's Screening of Groundwater Contamination Results from Previous Ground Investigations

- 7.6.11 The observed hydrogeology at the Keadby 2 Power Station Site from previous site investigations (references 1 and 2) indicated two shallow groundwater systems; one within the Made Ground and the other in permeable layers in the Alluvium. During the Exploration Associates (1992) investigation, groundwater levels were observed between 0.92 – 10.7m bgl across the Keadby 2 Power Station, while the Wimtec (1998) investigation observed a groundwater level of 1.8 – 8.0m bgl in the eastern section and 0.9 – 1.4m bgl in the western section. It was considered that locally, groundwater is laterally continuous and hydraulically connected to the surface watercourses adjacent to the Keadby 2 Power Station site and/ or the River Trent to the east. Mott MacDonald (1991) previously suggested that the level of the local groundwater table is artificially maintained by the extensive drainage systems in the area.
- 7.6.12 Previous investigations (references 3 and 4) provided baseline groundwater quality data. The range of heavy metals and selected organic compound concentrations recorded during these investigations was compared with the freshwater Environmental Quality Standards (EQS). Direct comparisons with the Drinking Water Standards (DWS) were not made due to the absence of groundwater abstractions for use in potable supplies.
- 7.6.13 In groundwater samples (from boreholes and grab samples from trial pits), previous site investigation data recorded exceedances of lead, sulphate, sulphide, pH and chloride when compared to the freshwater EQS assessment criteria. In the instances of sulphate, sulphide and chloride, the exceedances were by orders of magnitude. The large exceedances recorded in shallow groundwater were considered likely to be in relation to the chemical composition of the Made Ground in the area, through which the water flows. The method of sampling (i.e. grab samples from trial pits) at the time of the Exploration Associates (1992) investigation may also have contributed to the higher values recorded. Selenium was also found to be occasionally elevated, though no relevant EQS was available at the time of screening.

Ground Gas

- 7.6.14 A single round of gas monitoring was undertaken from two boreholes in the western section of Keadby 2 Power Station during the Wimtec (1998) investigation. No elevated levels of the landfill gases methane or carbon

dioxide were detected It was reported by ERM that the risk of ground gas was very low in these areas.

7.7 Structural Soils (2016) Interpretive Geotechnical Assessment on Ground Investigation

7.7.1 This report was also summarised in the ERM Phase 1 desk study (see Section 7.5 for further details).

Introduction

7.7.2 Structural Soils carried out intrusive investigations, laboratory testing and a geotechnical assessment of the site. The report discusses the findings of the investigations and determines the implications on foundation design for the Keadby 2 Power Station. Contamination testing and assessment did not form part of the scope of works.

Summary of Ground Conditions

7.7.3 Made Ground was encountered at most of the exploratory locations, with a typical thickness of 2m. The Made Ground had a variable composition of cobbles, clinker, concrete, metal, plastic and tarmac in a slightly sandy clayey matrix. PFA was also encountered at a shallow depth in one of the boreholes.

7.7.4 The superficial deposits had a total thickness of around 11-12m. Five separate sand and clay strata were noted in the Alluvium. Overall, the clays, silts and sands transitioned from cohesive to granular with depth. Organic clays and peat were noted in the superficial deposits between 1.8m and 3.5m bgl.

7.7.5 The weathered Mercia Mudstone bedrock was proven at an average depth of 15m bgl. The stratum was found to be unweathered at an approximate depth of 18m bgl.

7.7.6 The geotechnical assessment of the site details site preparation, foundation design, earthworks, pavement design and the protection of buried concrete.

7.7.7 Groundwater was encountered during the investigation in all the exploratory boreholes between 2.50m and 5.00m bgl. Longer term groundwater monitoring indicated groundwater levels between 1.00m and 1.50m bgl.

7.8 Structural Soils (2016) Additional Geotechnical Reports

7.8.1 These reports were also summarised in the ERM Phase 1 desk study (see Section 7.5 for further details).

Introduction

7.8.2 Three additional reports from Structural Soils Geotechnical were made available for review. These included:

- Structural Soils 2016. Geophysical Report;

- Structural Soils 2016. Minimum Requirements of Detailed Site Investigation; and
- Structural Soils 2016. Static Cone Penetration Testing Factual Report.

Summary of Key Findings

- 7.8.3 The Geophysical Report describes a geophysical survey carried out at Keadby 2 Power Station to investigate the presence of foundation structures. Four anomalies were identified in the survey and intrusive investigations were recommended to determine the nature of the objects.
- 7.8.4 The Minimum Requirements of Detailed Site Investigation describes the detailed ground investigation required prior to the construction of the Keadby 2 Power Plant.
- 7.8.5 The Static Cone Penetration Testing Factual Report describes the cone penetration tests carried out, the results and the derived geotechnical parameters for soils at the Keadby 2 site.

7.9 RSK (2016) Keadby Power Station, Preliminary Risk Assessment

- 7.9.1 This report was also summarised in the ERM Phase 1 desk study (see Section 7.5 for further details).

Introduction

- 7.9.2 The objectives of this report were to assess potential geo-environmental issues associated with proposed development west of the Keadby 1 Power Station, and to identify any implications for the subsequent soil and geotechnical ground investigation in accordance with Siemens' (the Client) Specification of Contamination Survey.

Summary of Key Findings

- 7.9.3 RSK carried out a robust assessment of historical data, and the study identified the possibility of low to moderate contamination on site, with potential linkages to sensitive receptors.
- 7.9.4 The assessment confirmed a potential moderate risk to future building structures and services associated with contaminants potentially present in soils, including corrosive substances and hydrocarbons, and risk to future site users and structures from ground gases within the Made Ground and infilled areas.
- 7.9.5 Moderate to low potential risks were identified that could affect future and adjacent site users, ground water and surfaces water, from contaminants such as asbestos. The potential contaminants stem from the sites historic use as a power station and its associated activities, as well as the potential for Made Ground.

- 7.9.6 During the site walkover, it was noted that there were no obvious signs of contamination, with the exception of rubble piles, which may have contained asbestos and other contaminants from the demolition of previous structures.
- 7.9.7 Therefore, recommendations were suggested by RSK for future investigation into the potential sources of contamination, to allow for the refinement of the CSM to confirm or eliminate potential linkages.

7.10 URS (2012) SSE Keadby, High pH (Alkaline) Drainage Water Options Appraisal

- 7.10.1 This report was also summarised in the ERM Phase 1 desk study (see Section 7.5 for further details).

Introduction

- 7.10.2 URS were commissioned by SSE to undertake an options appraisal to address the issue of high pH drainage water at Keadby Power Station (the site).
- 7.10.3 On 21 February 2012, a white cloudy substance was observed discharging into Red House Dyke (located approximately 120m north of the site) from a drainage line originating from the Power Station.

Conclusion

- 7.10.4 A preliminary CSM was developed. Steel slag reportedly used as a fill material during the construction of the Power Station was identified as the most likely source of the white cloudy substance observed.
- 7.10.5 Analysis of the white cloudy discharge indicated that the composition was typical of water influenced by the dissolution of lime. In addition, pH monitoring undertaken by SSE identified high pH drainage effluent in sections of the drainage network, indicating that the source of the high pH discharge is likely to be in this area. This monitoring also indicated that the potential release of the white cloudy discharge appeared likely to correspond to periods of low rainfall when there is minimal dilution of any groundwater that may have ingress into the site drainage network by surface water run-off from the site.

Recommendations

- 7.10.6 Following a review of the potential remedial options available, URS considered that the relining of the existing perforated drainage pipe presented the greatest cost-benefit to prevent potential future releases of the white cloudy substance into Red House Dyke. Prevention of potential groundwater ingress into the site drainage network in this area was considered likely to break the suspected source-pathway-receptor linkage.

7.10.7 In advance of any potential relining works being undertaken, URS recommended that further investigative works were undertaken in order to refine the preliminary CSM and provide additional supporting evidence.

7.11 URS (2010) Keadby Power Station, Environmental Site Assessment

7.11.1 This report was also summarised in the ERM Phase 1 desk study (see Section 7.5 for further details).

Introduction

7.11.2 URS Corporation Ltd was commissioned by Scottish and Southern Energy (SSE) to undertake an environmental site investigation at Keadby Power Station. The aim of this investigation was to assess the potential for contamination and the risks to receptors, as a result of an historical oil spill in the west of the site.

7.11.3 Five boreholes were drilled to a maximum depth of 3.0m bgl and were installed with groundwater monitoring wells.

Summary of Ground Conditions

7.11.4 Made Ground was encountered in each of the boreholes to a maximum depth of 1.45m bgl. The Made Ground comprised decorative gravel overlying sandy gravel and gravelly sand, which had a variable silt and clay content.

7.11.5 The Made Ground was underlain by Alluvium, which was predominantly composed of soft sandy silt. However silty sand with occasional clay and silt bands were also encountered in two boreholes.

7.11.6 Initial groundwater strikes varied between 0.9m – 2.0m bgl. Information obtained during the groundwater monitoring round indicates that the groundwater flows to the east.

Summary of Findings

7.11.7 Soil and groundwater samples were submitted to the laboratory for chemical analysis focusing specifically on the presence of TPH. URS review of the test results indicated that some contamination was detected, particularly in the soil and groundwater samples of BH102, located adjacent to the tanks to the west of Keadby 1. The bulk of the hydrocarbons were assessed to comprise predominantly long chained hydrocarbons.

7.11.8 URS compared the site specific screening criteria based on a continued commercial land use. A review of the information indicated that ground contamination detected in this investigation was unlikely to pose a significant risk of significant harm to human health.

7.11.9 Reported soil TPH and ethyl benzene concentrations were generally within two orders of magnitude of the screening criteria (which were considered by URS to be overly conservative). Therefore, URS stated the potential risks to

controlled waters from the identified soil contamination were considered to be low.

7.11.10 The potential risks associated with TPH concentrations in groundwater were also considered to be low, given the conservatism of the screening criteria and the absence of dissolved phase contamination down hydraulic gradient of the identified source area.

7.12 Exploration Associates (2002) Settlement Monitoring, Keadby Power Station

Introduction

7.12.1 This report presents and summarises the results from the settlement monitoring at Keadby Power Station, between June 2001 and June 2002. The purpose, reason for the settlement monitoring was not stated within the Exploration Associates report.

7.12.2 Fourteen settlement monitoring points were monitored around the water treatment plant area, in the south-eastern section of the site. Additionally, piezometers were installed at 3 no. locations at depths of 2.5m bgl, 5m bgl and 6m bgl. Piezometers were also monitored over a 12-month period.

Summary of Key Findings

7.12.3 The magnitude of the observed ground movements was very small. The maximum movement observed was -17.9mm, whereas the smallest movement was +0.2mm.

7.12.4 The piezometers showed an average groundwater fluctuation range of 0.15m. There was a sharp increase of 0.47m in the 6m deep piezometer in February 2002, likely corresponding to increased precipitation.

7.12.5 No correlation was found between the observed settlement and groundwater levels.

7.13 SSE (1999) Keadby Power Station, Permitted Preliminary Works and Access Road, Discovery of Asbestos 11 September 1998 – Close Out Report

7.13.1 AMEC Civil Engineering were carrying out cut and fill operations to the new road layout north of 'Bonnyhale Road'. Asbestos was discovered whilst carrying out the earthworks and the works were halted. As part of site remediation, material was taken from the PFA stockpiles and used to cap the area prior to recommencement of the roadworks. The asbestos analysis results indicated amosite and chrysotile (consistent with insulation or coating type material).

7.13.2 The asbestos contamination was indicated on a plan in an appendix of the report. It was located to the north of the North Soak Drain and Sheffield and South Yorkshire Navigation to the east of the Proposed Development Site.

7.13.3 It was recommended that further investigation was necessary to ascertain the extent of asbestos contamination. A remediation and/or containment strategy would then be required.

7.14 Mouchel (1992) Geotechnical Interpretative Report

7.14.1 This report was also summarised in the ERM Phase 1 desk study (see Section 7.5 for further details).

Introduction

7.14.2 This report contains information from four previous ground investigations undertaken in 1947, 1991 (2 no) and 1992 on the Keadby Power Station site. The purpose of the report was to discuss the findings of the investigations and assess the implications on foundation design. Contamination testing and assessment did not form part of the scope of works.

7.14.3 The previous ground investigations summarised in the report included:

- Soil Mechanics Ltd 1947. Investigation of the Site, Proposed Keadby Power Station;
- Wimpey Geotech 1991. Keadby Power Station, Phase 1 Site Investigation, Report on Ground Investigation;
- Exploration Associates Ltd 1992. Keadby Power Station: Site Contamination Assessment; and
- Exploration Associates Ltd 1992. Keadby Power Station, Factual Report on Ground Investigation.

Summary of Ground Conditions

7.14.4 Made Ground was reported to cover the site to an average depth of 2m bgl. The Made Ground was composed of sand, silt and clay, with PFA, clinker and other rubble.

7.14.5 Alluvium was encountered beneath the Made Ground and comprised loose to medium dense silty sands. The upper layers of the Cohesive Alluvium were encountered typically up to depths of 8.5m bgl. These upper layers contained thin lenses of soft peat. The lower sandy Alluvium layers contained gravel in places, with no organic matter being present.

7.14.6 The superficial deposits overlay the Mercia Mudstone, which was typically encountered at around 16m bgl. The mudstone was classified as weathered for approximately 5m before the boreholes encountered unweathered bedrock.

- 7.14.7 A large tip of PFA to the west of the main site was investigated in the 1991 Wimpey Geotech report. The material was considered to be reused in backfilling the basement area.
- 7.14.8 Geotechnical properties of the Alluvium and the weathered Mercia Mudstone are presented within the Mouchel report.
- 7.14.9 Groundwater was typically encountered at the base of the Made Ground typically at around 2m bgl.

7.15 Mott MacDonald (1991) Report on Pile Testing and Concrete Coring/Laboratory Testing

Introduction

- 7.15.1 Mott MacDonald was commissioned by Scottish Hydro-Electric (SHE) to assess the integrity and load bearing capacity of the piled foundations and sub-basement floor slab, beneath the previous main building at Keadby Power Plant prior to its demolition. This report describes the results and conclusions from these tests.

Summary of Key Findings

- 7.15.2 A non-destructive test on the two tested piles concluded that the piles were approximately 15m in length and of constant cross-section.
- 7.15.3 The pile testing showed that the integrity and load bearing capacity of the precast driven piles and sub-basement floor slab had been retained. They were considered adequate for the similarly loaded new building development.
- 7.15.4 Slightly longer piles than tested appeared to be a satisfactory method for providing additional support to the driven piles on any future developments, which would enable a larger working load.
- 7.15.5 Three additional Mott MacDonald Engineering reports were available, with limited information on ground conditions. These are listed below:
- Mott MacDonald 1991. Report on Demolition Vibration Monitoring;
 - Mott MacDonald 1991. Stage 1 Engineering Report; and
 - Mott MacDonald 1991. Structural Assessment Report.

7.16 Mott MacDonald (1991) Project Phoenix, Proposed Groundwater Abstraction

Introduction

- 7.16.1 Mott MacDonald were commissioned to assess whether it was feasible to extract 650m³/day of groundwater from the underlying Sherwood Sandstone Aquifer, at the location of the decommissioned coal-fired power station, Keadby.

Summary of Ground Conditions

- 7.16.2 Historical deep boreholes at the location of the power station, revealed 20m of silty sands and gravels, overlying the Mercia Mudstone (approximately 170m thickness), and that this deposit was found to overlie the Sherwood Sandstone Aquifer (estimated to be 1km thickness).

Conclusion

- 7.16.3 It was concluded that the underlying Sherwood Sandstone Aquifer could provide an accessible and relatively cheap source of feedwater make-up for the proposed new power station. However, this was dependent upon whether a licence to construct and operate a well would be granted by the National River Authority (NRA). At the time of writing, it was unlikely that the licence would be granted; however, the decision could be appealed against.

8.0 INITIAL CONCEPTUAL SITE MODEL

8.1 Introduction

8.1.1 This section is aimed at identifying possible risks, if any, arising from substances used or deposited on the Proposed Development Site, or from other sources of land contamination. Both past and current potentially contaminative land uses have been considered. It is based on the Proposed Development as a Low Carbon CCGT Generating Station and associated development including water, gas and grid connections and a landscaping and biodiversity management area, as described in **Chapter 4: The Proposed Development (ES Volume I - Application Document Ref. 6.2)**.

8.1.2 The risk assessment process for environmental contaminants is based on a source-pathway-receptor analysis. These terms can be defined as follows:

- **Source:** a contaminant or pollutant that is in, on or under the land and that has the potential to cause harm or pollution; and
- **Pathway:** a route by which a receptor is or could be affected by a contaminant: examples include ingestion of contaminated soil and leaching of contaminants from soil into watercourses; and
- **Receptor:** something that could be adversely affected by a contaminant: examples include human occupants/ users of Proposed Development Site, water resources (surface waters or groundwater), or structures.

8.1.3 For a risk to be present, there must be a relevant/ viable contaminant linkage; i.e. a mechanism whereby a source can reasonably impact on a sensitive receptor via a pathway.

8.1.4 The following sections detail the initial CSM which has been developed for the Proposed Development Site with a view to assessing the potential risks/liabilities and constraints associated with the Proposed Development Site in its current condition prior to the Proposed Development taking place. Risks associated with the Proposed Development have also been assessed based on an industrial future land use scenario, including any potential sources of contamination, potential receptors and potential contaminant pathways identified during this desk-based assessment.

8.2 Sources of Potential Contamination

8.2.1 This section highlights those former and current on-site and off-site activities that have been identified as potential sources of contamination for the Proposed Development Site. These activities may have in turn impacted on soil, soil leachate and groundwater.

8.2.2 Table 10 indicates potential on-site and off-site sources of contamination identified from this phase 1 desk-based assessment. With reference to the NHBC/ CIEH/ Environment Agency Guidance for the Safe Development of Housing on Land Affected by Contamination, R&D Publication 66: 2008.

Table 10 also indicates the potential contaminants that may be associated with the potential sources identified.

Table 10: Potential sources of contamination

Location with respect to the Proposed Development Site	Potential source	Associated Contaminants of Potential Concern (CoPC)
On-site (central/eastern area)	Keadby I Power Station (formerly coal-fired, currently gas-fired), including tanks	Potential for metals and semi-metals; inorganics (sulphate, sulphide, asbestos, pH); organics (oil/ fuel hydrocarbons, PAH, VOC and semi volatile organic compounds (SVOC), PCB.
6 no. located on-site (central/western areas)	Former landfill sites	Various deposited wastes including inert, industrial, commercial, household and special waste. Potential for a range of inorganic and organic contaminants including but not limited to heavy metals, acids, organic compounds, inorganic compounds, asbestos, TPH, PAH, VOC, SVOC, solvents, lubricants, fuel oils, alkalis, PCB. Potential for ground gases including methane, hydrogen sulphide and carbon dioxide.
On-site and off-site (various directions)	Current and former agricultural land	Contamination resulting from leaks and spills of liquids and solids, use of agricultural chemicals, potential burial of animal remains. Potential for a range of organic and inorganic contaminants including, but not limited to, metals, hydrocarbons (diesel range, lubricating oils, solvents), ammonia, elevated biochemical oxygen demand (BOD), elevated chemical oxygen demand (COD), pesticides pathogens and asbestos.
On-site (in the south and south-west) and off-site (adjacent to	Current and former railways	Potential for metals and semi-metals; inorganics (sulphate, asbestos); organics (PAH, chlorinated aliphatic hydrocarbons, PCB).

Location with respect to the Proposed Development Site	Potential source	Associated Contaminants of Potential Concern (CoPC)
the southern boundary)		
On-site and off-site	Marshland, peat	Potential low levels of ground gas – methane and carbon dioxide.
2 no. located off-site (15m and 25m to the west)	Former landfill sites	Waste types unknown, although one of which was named a 'Pulverised Fuel Ash' Settlement Lagoon Potential for a range of inorganic and organic contaminants including but not limited to heavy metals, acids, organic compounds, inorganic compounds, asbestos, TPH, PAH, VOC, SVOC, solvents, lubricants, fuel oils, alkalis, PCB. Potential for ground gases including methane, hydrogen sulphide and carbon dioxide.
Off-site (20m and 120m from the Waterborne Transport Off-Loading Area)	Depot and warehouse	Unknown. Potential contamination resulting from leaks and spills of liquids and solids; asbestos.
Off-site (55m west of the Additional Abnormal Indivisible Load Route)	PD Ports Marina	Potential for metals and semi-metals; inorganics (sulphate, sulphide, asbestos); organics (phenol, PAH, chlorinated aliphatic hydrocarbons, hexachlorocyclohexane, chlorinated aromatic hydrocarbons, PCB).
Off-site (200m north and south-east of the Water Connection Corridor)	Former S L Cleaning Services; commercial cleaning services	Potential for metals and semi-metals; inorganics (free cyanide, nitrate, sulphate, asbestos, pH); organics (aromatic hydrocarbons, chlorinated aliphatic hydrocarbons, PCB).
Off-site (220m south of the Waterborne Transport Off-Loading Area)	Historical tank	Potential for TPH, PAH, hydrocarbons

8.3 Potential Pathways

8.3.1 Potential pathways associated with the Proposed Development Site are shown in Table 11, below.

Table 11: Potential Pathways

Pathway Reference	Pathway
P1	Direct contact/ ingestion of contaminants within Made Ground/ soils, together with soil derived dust and groundwater.
P2	Inhalation of organic vapours from Made Ground/ soils, soil derived dust, and groundwater.
P3	Leaching of soluble contaminants and migration of mobile contaminants into shallow groundwater.
P4	Vertical groundwater flow through Made Ground and superficial deposits to underlying bedrock aquifer.
P5	Lateral groundwater flow and direct run-off to surface waters.
P6	Vertical migration of ground gases to indoor and outdoor air and migration of ground gases into enclosed spaces (inhalation/ asphyxiation/ explosion).
P7	Inhalation of asbestos fibres.
P8	Direct contact of buried concrete with contaminated soils (i.e. hydrocarbons) and aggressive ground conditions (pH and sulphate)/ direct contact of services and supply pipes with contaminated soils.
P9	Indirect Pathway: Migration of hazardous gases/vapours via permeable strata into enclosed spaces and service/utility trenches.

8.4 Potential Receptors

8.4.1 Potential receptors associated with the Proposed Development Site are shown on Table 12, below.

Table 12: Potential receptors

Receptor reference	Receptor
R1	Human health (on-site users): (chronic) Current commercial users (workers at Keadby 1 Power Station)
R2	Human health (on-site users): (acute)

Receptor reference	Receptor
	Current public open space users (Keadby Common users)
R3	Human health (on-site users): (chronic) Current residential users (residential on the eastern-most spur only)
R4	Human health (on-site users): (chronic) Future commercial users (workers at Keadby 2 Power Station and Keadby 3)
R5	Human Health (off-site users): (acute) Current and future commercial and public open space users (surrounding) Current and future residential users (Keadby village, adjacent to the east)
R6	Groundwater: superficial geology (Alluvium/ Warp) is classified as a Secondary A aquifer Groundwater abstraction located on-site (not potable)
R7	Groundwater: bedrock geology (Mercia Mudstone Formation) is classified as a Secondary B aquifer.
R8	Surface Waters: located on-site and off-site (various unnamed drains, River Trent (Humber Upper), Paupers Drain (includes Warping Drain and Eastoft Moors Drain)/ Eastoft Moors (Warping) Drain, Sewer Drain, North Soak Drain, Sheffield and South Yorkshire Navigation/ Stainforth and Keadby Canal, South Soak Drain, Torne/Three Rivers (includes South Engine Drain and Folly Drain), Hatfield Waste Drain, North Level Engine Drain, South Level Engine Drain and River Torne.) Surface water abstractions located on-site and off-site (not potable)
R9	Building and infrastructure: located on-site and off-site: infrastructure at risk from ignition of gas in confined space, below ground infrastructure at risk from aggressive ground conditions
R10	Ecological sites: Ramsar Site, SSSI and SAC – Humber Estuary
R11	Non-statutory designated ecological sites: LWS – Keadby Warping Drain, Stainforth and Keadby Canal Corridor, Keadby Boundary Drain, Keadby Wetland, South Soak Drain, Keadby, Keadby Wet Grassland, Three Rivers, Hatfield Waste Drain, North Engine Drain, Belton, River Torne, South Engine Drain, Belton

9.0 ENVIRONMENTAL RISK ASSESSMENT

9.1 Risk Assessment Principles

- 9.1.1 Current best practice recommends that the determination of hazards due to contaminated land is based on the principle of risk assessment, as outlined in the Environment Agency’s recently published revised online guidance for the management of land contamination ‘Land contamination: risk management (LCRM)’ (Environment Agency, 2020).
- 9.1.2 For a risk to be present, there must be a viable contaminant linkage; i.e. a mechanism whereby a source impacts on a sensitive receptor via a pathway.
- 9.1.3 Assessment of risks associated with each of these potential contaminant linkages are discussed in the following sections.
- 9.1.4 Using criteria broadly based on those presented in Section 6.3 of the CIRIA Report “Contaminated Land Risk Assessment: A Guide to Good Practice” (CIRIA Report C552) the magnitude of the risk associated with potential contamination at the Proposed Development Site has been assessed. To do this, an estimate is made of:
- the magnitude of the potential consequence (i.e. severity); and
 - the magnitude of probability (i.e. likelihood).
- 9.1.5 The severity of the risk is classified according to the criteria in Table 13, below.

Table 13: Severity of the risk

Severity	Definition and Examples
Severe	Acute risks to human health, likely to result in “significant harm” (e.g. very high concentrations of contaminants/ ground gases). Catastrophic damage to buildings/ property (e.g. by explosion, sites with high gassing potential, extensive VOC contamination). Major pollution of controlled waters (e.g. surface watercourses or Principal aquifers/ SPZ). Short term risk to a particular ecosystem.
Medium	Chronic (long-term) risk to human health likely to result in “significant harm” (e.g. elevated concentration of contaminants/ ground gases). Pollution of sensitive controlled waters (e.g. surface watercourses or Principal/ Secondary aquifers). Significant effects on sensitive ecosystems or species.
Mild	Pollution of non-sensitive waters (e.g. smaller surface watercourses or non-aquifers). Significant damage to crops, buildings, structures or services (e.g. by explosion, sites with medium gassing potential, elevated concentrations of contaminants).

Severity	Definition and Examples
Minor	Non-permanent human health effects (requirement for protective equipment during site works to mitigate health effects). Damage to non-sensitive ecosystems or species. Minor (easily repairable) damage to buildings, structures or services (e.g. by explosion, sites with low gassing potential).

9.1.6 The probability of the risk occurring is classified according to the criteria in Table 14, below.

Table 14: Likelihood of risk occurrence

Likelihood	Explanation
High	Contaminant linkage may be present that appears very likely in the short-term and risk is almost certain to occur in the long term, or there is evidence of harm to the receptor.
Likely	Contaminant linkage may be present, and it is probable that the risk will occur over the long term.
Low	Contaminant linkage may be present and there is a possibility of the risk occurring, although there is no certainty that it will do so.
Unlikely	Contaminant linkage may be present but the circumstances under which harm would occur even in the long-term are improbable.

9.1.7 An overall evaluation of the level of risk is gained from a comparison of the severity and probability, as shown in Table 15, below.

Table 15: Risk based on comparison of likelihood and severity

		Severity			
		SEVERE	MEDIUM	MILD	MINOR
Likelihood	HIGH	Very High	High	Moderate	Moderate/low
	LIKELY	High	Moderate	Moderate/low	Low
	LOW	Moderate	Moderate/low	Low	Very Low
	UNLIKELY	Moderate/low	Low	Very Low	Very Low

9.2 Preliminary Risk Assessment

- 9.2.1 In accordance with the risk assessment principles outlined above, a preliminary evaluation of the potential risks associated with all the identified sources at the Proposed Development Site (Table 10), through the potential pathways (P1 to P9) to the various potential receptors (R1 to R11) is discussed and presented in Table 16, below. The level of risk is determined based on the current condition of the Proposed Development Site (i.e. the effects of mitigation measures are not included). Mitigation is then proposed based on the significance of the risk. In some cases, a degree of mitigation is assumed as part of legislative requirements or standard construction practice. This is acknowledged where these assumptions are made.
- 9.2.2 The preliminary risk assessment undertaken within this section does not consider acute linkages for construction and maintenance workers. AECOM anticipates that these acute linkages will be managed by appropriate health and safety measures. These are discussed further in Section 9.3.

Table 16: Preliminary risk assessment

Receptor	Pathway	Potential severity	Likelihood of occurrence	Potential risk	Linkage reference	Justification
R1, R2, R3: Human Health (on-site users): Current commercial and public open space users (workers at existing Keadby Power Station and Keadby Common users) Current residential users (residential on the eastern-most spur only)	P1: Direct contact/ingestion of contaminants within Made Ground/soils, together with soil derived dust and groundwater	Medium	Low	Moderate / low	L1	The Proposed Development Site has the potential for contamination from various sources, predominantly including the former coal fired power station and the current Keadby 1 power station and a number of on-site and nearby off-site former landfills. L1: The potential risk to current on-site users from direct contact/ ingestion of contaminants has been assessed as moderate/low. The current Keadby 1 Power Station area is currently hardstanding and buildings, reducing exposure risk. Areas of exposed ground are not routinely used by members of the public beyond the immediate power station footprint; the risk is therefore considered to be moderate/low as they are temporary site users and their time on-site will be transient. It should also be noted that access by members of the public will be classed as unofficial due to the Proposed Development Site being
	P2: Inhalation of organic vapours from Made Ground/ soils, soil derived dust and groundwater	Medium	Low	Moderate / low	L2	
	P6: Vertical migration of ground gases to indoor and outdoor air and migration of ground gases into enclosed spaces (inhalation/	Severe	Unlikely to low	Moderate / low to moderate	L3	

Receptor	Pathway	Potential severity	Likelihood of occurrence	Potential risk	Linkage reference	Justification
	asphyxiation/ explosion)					<p>secure with no public right of way. The residential users are located on the eastern-most spur only, and therefore although considered to be a high sensitivity receptor, the potential risk is considered to be moderate/low due to their proximity from the main potential sources of contamination (i.e. the former coal fired power station, current Keadby 1 Power Station and the former landfills).</p> <p>L2: The level of risk with regards to potential vapours emanating from within Made Ground is considered to be moderate/low due to the severity of the hazard rather than the likelihood of occurrence. Hardstanding across some of the Proposed Development Site again reduces the risk to a degree.</p> <p>L3: Ground gases may be present due to the extent of former landfills on-site and off-site. The risks are considered to be moderate/low for the public open space users (as they will not be accessing confined environments) and residential users (based on their distance from the</p>
	P7: Inhalation of asbestos	Severe	Unlikely	Moderate / low	L4	

Receptor	Pathway	Potential severity	Likelihood of occurrence	Potential risk	Linkage reference	Justification
						<p>former landfills); and moderate for the workers within the existing Keadby 1 Power Station and current Keadby 2 construction workers.</p> <p>L4: There is potential for asbestos to be present in any Made Ground on-site and potentially within buildings (depending on their age). As asbestos presents a risk if it is disturbed, it is considered that the likelihood of this risk being realised is unlikely and therefore the overall risk moderate/low has been concluded. If asbestos is encountered during future redevelopment, it must be managed in accordance with the Control of Asbestos Regulations 2012.</p> <p>Further site characterisation/assessment will be required to quantify the significance of the risks identified.</p>
R4: Human Health (on-site users): Future commercial	P1: Direct contact/ingestion of contaminants within Made Ground/ soils, together with soil	Medium	Unlikely	Low	L5	The Proposed Development will comprise of mainly hardstanding and buildings. It is understood that there are no plans to provide public access to the Proposed Development Site post-construction.

Receptor	Pathway	Potential severity	Likelihood of occurrence	Potential risk	Linkage reference	Justification
users (workers at existing Keadby Power Station and Proposed PCC Site)	derived dust and groundwater					<p>L5: The potential risk to future on-site users from direct contact/ ingestion of contaminants has been assessed as low due to proposed hardstanding and buildings limiting the potential exposure to CoPC and hence reducing exposure risk. Furthermore, wind-blown particulates are unlikely to be mobilised due to future development cover.</p> <p>L6: The risk from vapours emanating from within Made Ground is considered to be moderate/low. Hardstanding will reduce the likelihood of risk being realised to a degree.</p> <p>L7: Ground gases may be present due to the extent of former landfills on-site and off-site. The risks from ground gases are considered to be moderate for the future workers within the Proposed Development Site. If ground gases are found to be present, these will need to be mitigated as part of any future building design.</p> <p>L8: Any Made Ground found to be contaminated with asbestos or buildings</p>
	P2: Inhalation of organic vapours from Made Ground/soils, soil derived dust, and groundwater	Medium	Low	Moderate / low	L6	
	P6: Vertical migration of ground gases to indoor and outdoor air and migration of ground gases into enclosed spaces (inhalation/ asphyxiation/ explosion)	Severe	Low	Moderate	L7	
	P7: Inhalation of asbestos	Severe	Unlikely	Moderate / low	L8	

Receptor	Pathway	Potential severity	Likelihood of occurrence	Potential risk	Linkage reference	Justification
						containing asbestos will require suitable management if it is to be retained on-site. Further site characterisation/assessment will be required to quantify the significance of the risks identified.
R5: Human Health (off-site users): Current and future commercial and public open space users (surrounding) Current and future residential users (Keadby village, adjacent to the east)	P1: Direct contact/ingestion of contaminants within Made Ground/ soils, together with soil derived dust and groundwater	Medium	Unlikely	Low	L9	L9: The potential for direct contact/ingestion of contaminants on-site is considered to be low based on the proximity of the off-site users. L10: There is a potential for organic soil contamination to be present on-site. The risk to confined spaces located in off-site areas from accumulation of site-derived vapour and potential inhalation is considered to be low.
	P2: Inhalation of organic vapours from Made Ground/soils, soil derived dust, and groundwater	Medium	Unlikely	Low	L10	Measures to control the generation of soil derived dust/vapours should be outlined in the Construction Environmental Management Plan taking into account CIRIA C741 4th Edition 'Environmental Good Practice On Site' (2015).
	P6: Vertical migration of ground gases to indoor and outdoor air and migration of	Severe	Unlikely	Moderate / low	L11	L11: Ground gas may be generated within the Proposed Development Site due to the extent of Made Ground expected as a result of the former landfills. There is

Receptor	Pathway	Potential severity	Likelihood of occurrence	Potential risk	Linkage reference	Justification
	ground gases into enclosed spaces (inhalation/ asphyxiation/ explosion)					potential for ground gas (if present) to migrate off-site and affect nearby properties although there is no evidence this is happening currently.
R6 and R7: Groundwater: Secondary A aquifer (superficial - Alluvium/ Warp) Secondary B aquifer (bedrock - Mercia Mudstone Formation) Groundwater abstraction located on-site (not potable)	P3: Leaching of soluble contaminants and migration of mobile contaminants into shallow groundwater P4: Vertical groundwater flow through Made Ground and superficial deposits to underlying bedrock aquifer	Medium	Low	Moderate / low	L12	L12: Groundwater levels within the historical borehole records indicate shallow groundwater levels within the superficial geology of between 0.9m – 3.0m bgl. Occasionally, deeper groundwater strikes were recorded between 5.4m – 6.9m bgl. Lateral and vertical migration through preferential pathways within the Made Ground may facilitate infiltration to the underlying superficial Secondary A aquifer. The extent to which the groundwater in the superficial deposits is connected to groundwater in the underlying Mercia Mudstone (Secondary B aquifer) is not confirmed. There is a groundwater abstraction located on-site although this is not for potable water. It is considered that there is a moderate/ low risk for contamination to impact the groundwater

Receptor	Pathway	Potential severity	Likelihood of occurrence	Potential risk	Linkage reference	Justification
						within the superficial deposits and potentially bedrock. Monitoring would be required to confirm the current groundwater quality regime.
R8: Surface Waters: located on-site and off-site Surface water abstractions located on-site and off-site (not potable)	P5: Lateral groundwater flow and direct run-off to surface waters	Medium	Low to likely	Moderate / low to moderate	L13	L13: The nature of the Proposed Development Site and it's surrounding area, including the indicated naturally high groundwater levels and the proximity of numerous surface water features, indicates a potential for the groundwater to provide base flow to surface water receptors. The surface water features vary in quality, with various river quality gradings between Grade E (year: 2000) to Grade A - very good (year: 2009). Therefore, there is considered to be a moderate/low to moderate potential risk to surface watercourses and the surface water abstractions (not potable), depending on the proximity of a specific

Receptor	Pathway	Potential severity	Likelihood of occurrence	Potential risk	Linkage reference	Justification
						water course/ abstraction, its sensitivity, and whether the canals and drains are lined (potentially reducing the potential pathway).
R9: Building and infrastructure: located on-site and off-site	P8: Aggressive attack through direct contact with natural ground or contaminants within Made Ground/ soils, leachate and groundwater	Mild	Likely	Moderate / low	L14	L14: The risk to foundations and services is considered to be moderate/low based on the potential for on-site contamination within the Made Ground/soils, leachate and groundwater. L15: Ground gases may be present due to the extent of former landfills on-site and off-site and so there is the potential for ground gas migration and build-up in confined spaces. Where methane is identified at certain levels, there is the potential for explosion to occur, albeit unlikely. If ground gases are found to be present, these will need to be mitigated as part of the future Proposed Development design.
	P9: Ground gas accumulation and potential explosion risk	Severe	Unlikely to low	Moderate / low to moderate	L15	
R10: Ecological sites: Ramsar Site, SSSI and SAC –	P1: Direct contact/uptake of contaminants within Made Ground/soils,	Medium	Low	Moderate / low	L16	L16: The risk to the Humber Estuary SAC, Ramsar site and SSSI which encompass the River Trent at the locations of the proposed cooling water abstraction and outfall for the Proposed

Receptor	Pathway	Potential severity	Likelihood of occurrence	Potential risk	Linkage reference	Justification
Humber Estuary	leachate and groundwater					Development is considered to be moderate/low based on the sensitivity of this designated ecological site. L17: The risks to the identified non-statutory designated ecological sites (LWS) is considered to be low. If phytotoxic contaminants are found to be present within the Made Ground, these can normally be mitigated through suitable topsoil/ subsoil cover.
R11: Ecological sites: LWS	P1: Direct contact/uptake of contaminants within Made Ground/soils, leachate and groundwater	Mild	Low	Low	L17	

9.3 Discussion of Risks to Construction Workers and Off-site Receptors during Construction Works.

- 9.3.1 As described in **Chapter 4: The Proposed Development** (ES Volume I - **Application Document Ref. 6.2**) and **Chapter 5: Construction Programme and Management** (ES Volume I - **Application Document Ref. 6.2**), the Proposed Development works will be undertaken in compliance with Construction Design and Management Regulations 2015 (CDM).
- 9.3.2 Prior to work commencing, a health and safety risk assessment should be carried out by the appointed Principal Contractor and this should be developed in accordance with current health and safety regulations. This assessment should cover potential risks to construction staff, permanent site staff and the local surrounding population. Based on the findings of this risk assessment, appropriate mitigation measures should be implemented during the construction period.
- 9.3.3 The greatest potential for generation of dust will be during the enabling and construction works. Dust generation will be minimised through the use of measures which will be outlined in the Framework Construction Environmental Management Plan (CEMP) (**Application Document Ref. 7.1**) submitted with the DCO Application. This will take into account relevant best practice, for example, 'Environmental Good Practice on Site', CIRIA Publication C692 to reduce this risk to acceptable levels.
- 9.3.4 The risk to future construction workers is considered to be low; however, this assumes the preparation of a construction management and health and safety plan including the use of PPE in accordance with statutory health and safety requirements. The potential for ground gas risks should be considered when developing Health and Safety Plans for works at the Proposed Development Site and a monitoring programme for occupational exposure risk should be considered.
- 9.3.5 Further details regarding the management of dust during the construction phase are available within **Chapter 8: Air Quality** (ES Volume I - **Application Document Ref. 6.2**) and **Appendix 8A: Construction Air Quality** (ES Volume II - **Application Document Ref. 6.3**).

10.0 PRELIMINARY GROUND ENGINEERING RISK ASSESSMENT

10.1.1 A summary of the ground-related risks identified in this report is given in Table 17, below. The risks identified as being potentially present on the Proposed Development Site could have potential implications on both ground engineering and foundation design.

Table 17: Summary of the ground-related risks

Hazard	Source	Hazard Potential	Engineering Implication	Mitigation Methods
Soft/compressible deposits (low bearing capacity and high settlement)	The published geology and historic boreholes indicate the presence of soft/firm clay, silt and peat. The peat might cause local areas of settlement. Envirocheck data for the site confirms that the potential for compressible ground stability hazards is moderate.	High	Potential for excessive settlement and differential settlement.	Ground investigation with appropriate testing to understand the compressibility of the deposits, to determine the ground conditions and ensure a safe design.
Made Ground	Made Ground associated with the historical development of the Proposed Development Site as a former power station and on-site historical landfill activities will likely be present and potentially deep, especially in the	Medium	Made Ground, given its general vertical and lateral variability, is unsuitable as a founding stratum unless re-engineered.	The extent of any Made Ground will be confirmed through the ground investigation. Dependent on depth/thicknesses and material types ground improvement, appropriate foundations are to be considered.

Hazard	Source	Hazard Potential	Engineering Implication	Mitigation Methods
	areas of former landfill.			Removal/replace ment of the Made Ground may be considered as an option.
Lateral changes in ground conditions	The Published Geology and historical ground investigation reports indicate that there could be lateral variation in the unit thicknesses and geotechnical properties across the site.	Medium	Variable ground conditions could mean that a single engineering solution might not be appropriate for the whole site.	Ground investigation would reduce the uncertainty in the variable ground conditions; however, it is unlikely to completely eliminate the risk.
High groundwater table (including waterlogged ground)	The historical records indicate a shallow groundwater level, between 0.9m and 3.0m bgl. Two groundwater tables are implied, namely a perched table in the Made Ground and a permanent table in the Alluvium. Excavations at Keadby 2 Power Station (currently under construction) required dewatering.	Medium	High groundwater levels lead to the flooding of excavations, which can make any excavations for foundations or services unstable. It can also impact the stability of strata below the groundwater table and cause uplift.	Groundwater monitoring as part of the ground investigation to confirm the site-specific groundwater levels. If a high groundwater table is confirmed, suitable dewatering and/or temporary support may be required.

Hazard	Source	Hazard Potential	Engineering Implication	Mitigation Methods
Aggressive ground (e.g. expansive slags, weathering of sulphides to sulphates)	Made Ground. The Mercia Mudstone Group is also generally pyritic and contains naturally elevated sulphate concentrations.	Medium	Concrete attack on the structure's foundations.	Concrete foundations and service ducts are likely to need to be designed against natural chemical attack from aggressive ground conditions.
Existing sub-structures (e.g. foundations, basements, and adjacent sub-structures)	Given the almost exclusive agricultural history of the main proposed development site, it is unlikely that buried structures will be encountered. However, it is possible that construction waste from the construction of Keadby 1 and 2 Power Plants is present.	Medium	Delays in ground investigation and construction works due to obstructions.	Ground investigation will reduce the uncertainty of the ground conditions but is unlikely to eliminate the risk.
Utilities	Utilities Survey identified utilities within and adjacent to the proposed development site.	High	Design to avoid utilities or reroute utilities as necessary. Potential to strike utilities as part of design or construction works.	Use of Ground Penetrating Radar and CAT scan before breaking ground to avoid utility strikes. Detailed survey of utilities present for design. Possible consultation with

Hazard	Source	Hazard Potential	Engineering Implication	Mitigation Methods
				utility companies regarding diversions.
UXO	Zetica Risk Map and 6 Alpha Threat Assessment indicates that the UXO risk is low for the site.	Low	No engineering implication.	No mitigation measures required.

11.0 CONCLUSIONS

11.1 Summary

11.1.1 The assessment presented in this Appendix has identified that:

- The Proposed Development Site is currently occupied by Keadby 1 Power Station (in the central and eastern areas) and Keadby 2 Power Station (under construction) as well as former agricultural land. The Proposed Development Site includes land associated with the former coal-fired Keadby Power Station (now demolished). The current Keadby 1 Power Station is gas-fired. Extensive historical landfilling has been identified on-site and off-site in close proximity (to the west). Based on a review of current and historical mapping and identification a number of potential sources (the aforementioned coal-fired power station and associated infrastructure and the former landfills being potentially the most significant), encountering ground contamination is considered to be likely.
- Ground gas sources exist from the underlying Made Ground (depending on its thickness and composition) and from historical landfills.
- The geological stratigraphic sequence beneath the Proposed Development Site is likely to comprise Made Ground, overlying superficial deposits. These superficial deposits are composed of Warp and Alluvium, which is more cohesive at the top and becomes more granular closer to the bedrock. The bedrock is Mercia Mudstone, which lies at an approximate depth of 14m bgl.
- The superficial deposits are classified as a Secondary A aquifer and the solid geology a Secondary B aquifer. There is a groundwater abstraction located on-site (not for potable water). Groundwater is likely to be present near surface (1m to 3m bgl) located within the superficial deposits. This may affect temporary and permanent works.
- There are numerous surface watercourses and surface water abstractions (not for potable water) on-site and within the study area. The surface water features vary in chemical quality, with various reported river quality gradings between Grade E (year: 2000) to Grade A - very good (year: 2009).
- The Humber Estuary is located on the eastern-most extent of the Proposed Development Site and adjacent to the east. This is a designated Ramsar Site, SSSI and SAC. A number of LWS site have also been identified in proximity to the Proposed Development Site.

11.1.2 Based on the initial CSM and preliminary risk assessment, the Proposed Development Site represents a generally moderate/ low to moderate risk in terms of the risk to the human health of current and future on-site occupants in the absence of mitigation and a low to moderate/ low risk to the human health of off-site users. A moderate/ low risk for contamination to impact the

groundwater within the superficial deposits and bedrock, and a moderate/ low to moderate potential risk to surface water receptors has been assigned. The risk to the Humber Estuary statutory ecological designations is considered to be moderate/low based on the sensitivity of this designated ecological site. The risks to the non-statutory designated LWS sites is considered to be low.

- 11.1.3 The risk ratings are mainly related to the potential for contamination to be present at elevated concentrations which may pose harm to receptors because of the type of land use (heavy industrial and landfilling) undertaken at the Proposed Development Site. However, generally the likelihood of the linkage being realised was mainly assigned as low rating. The overall risk rating of low to moderate is not uncommon for brownfield sites.
- 11.1.4 Key identified geotechnical hazards that should be considered in future design of the Proposed Development include; the presence of potentially deep Made Ground, lateral changes in the ground conditions, potential for compressible ground stability hazards, high groundwater table, adverse ground chemistry and existing sub-structures. The depth of the Alluvium and potential presence of compressible deposits might require ground improvement and/or a deeper piled foundation solution.
- 11.1.5 The contaminative and geotechnical risks can be mitigated by further assessment through intrusive ground investigation and risk assessment at the detailed design stage, and if necessary, the inclusion of routine construction measures for example, ground gas protection measures within buildings.

12.0 RECOMMENDATIONS

12.1 Summary

- 12.1.1 In order to characterise the potential risks identified and allow for the refinement of the initial CSM, it is recommended that a preliminary intrusive ground investigation is carried out. From this the composition, extent and depth of the Made Ground, the natural superficial deposits and the bedrock across the Proposed Development Site can be confirmed. This will determine the underlying stratigraphy to inform the detailed ground investigation and design of suitable engineering works.
- 12.1.2 During the intrusive investigation, it is recommended that representative soil samples are taken to determine the chemical status of Made Ground and natural soils. Samples should also be taken to determine the ground strength and compressibility parameters to inform the geotechnical design. Groundwater monitoring and sampling and ground gas monitoring will also need to be undertaken at the Proposed Development Site.
- 12.1.3 The site investigation should be designed with due consideration of the requirements of BS 5930 (2015) Code of Practice for Ground Investigation; Environment Agency (2005), BS10175: 2011+A2:2017 Investigation of potentially contaminated sites – Code of Practice and the UK Specification for Ground Investigation (2nd Edition) published by ICE Publishing in 2012 and Eurocode - BS EN 1997-1:2004, BS EN 1997-2:2007 'Eurocode 7 - Geotechnical design - Ground investigation and testing'.
- 12.1.4 After completion of intrusive works and monitoring, the geo-environmental condition of the Made Ground and underlying superficial deposits should be assessed. The soil, soil leachate and groundwater samples and ground gas readings should be analysed for the purpose of risk assessment to human health, controlled waters and assessment of the chemical properties with respect to buried structures. Identification of geotechnical design parameters for earthworks and preliminary foundation design should also be undertaken.
- 12.1.5 A ground investigation report should be produced for geo-environmental and geotechnical risk identification and interpreted.
- 12.1.6 The investigation will allow a quantitative assessment as to whether any of the potential risks identified in this Appendix are present and are of material concern to the Proposed Development.

13.0 REFERENCES

British Geological Survey (2020) *British Geological Survey Geological Mapping and Memoirs*. Available online:
<https://www.bgs.ac.uk/data/maps/maps.cfc?method=listResults&MapName=&series=E50k&scale=&pageSize=100&getLatest=Y>

British Geological Survey (2020) *Geoindex*. Available online:
<https://www.bgs.ac.uk/geoindex/>

British Standards (BS) 5930 (2015) *Code of Practice for Ground Investigation*.

BS EN 1997-1:2004, BS EN 1997-2:2007 *Eurocode 7: Geotechnical Design – Ground investigation and testing*.

Construction Industry Research and Information Association (CIRIA) (2001) publication C552: *Contaminated land risk assessment - a guide to good practice*.

Cranfield Soil and AgriFood Institute (CSAI) *Soilscapes viewer*. Available online:
<http://www.landis.org.uk/soilscapes/>

DEFRA (2020) *Magic Maps*. Available online: <https://magic.defra.gov.uk/>

Environment Agency (2018) *The Environment Agency's approach to groundwater protection*. Available online:
https://assets.publishing.service.gov.uk/government/uploads/system/uploads/attachment_data/file/692989/Environment-Agency-approach-to-groundwater-protection.pdf

Environment Agency (October 2020). *Land Contamination: Risk Management – Version 3*. Available online:
<https://www.gov.uk/government/publications/land-contamination-risk-management-lcrm>

Environment Agency BS10175 (2011+A2:2017) *Investigation of potentially contaminated sites – Code of Practice*.

Environmental Resources Management (ERM) (2016). *Keadby 2 Power Station Environmental Statement*.

Environmental Resources Management (ERM) (2017). *Project Keadby Power Station: Phase 1 Desk Study Report*.

Environmental Resources Management (ERM) (2017). *Phase II Baseline Investigation Keadby*.

Exploration Associates (2002). *Settlement Monitoring: Keadby Power Station*.

Google Earth Pro (2021) *Current and recent-historical mapping from Google Earth Pro.*

Institute of Civil Engineers (ICE) (2012) *UK Specification for Ground Investigation* (2nd edition).

Landmark Information Group (May 2020) *Envirocheck Historical maps report: Reference 242986885_1_1.*

Ministry of Housing, Planning & Local Government (2019). *National Planning Policy Framework.*

Mott MacDonald (1991). *Report on Pile Testing and Concrete Coring/Laboratory Testing.*

Mott MacDonald (1991). *Project Phoenix, Proposed Groundwater Abstraction.*

Mouchel (1992) *Geotechnical Interpretative Report.*

National House Building Council/Chartered Institute of Environmental Health/Environment Agency (NHBC/CIEH/EA) (2008) *Guidance for the Safe Development of Housing on Land Affected by Contamination, R&D Publication 66.*

National Library of Scotland (2021) *National Library of Scotland website.* Available online: <https://www.nls.uk/>

North Lincolnshire Council (May 2003) *North Lincolnshire Adopted Local Plan.*

Public Health England (2020) *UK radon* (accessed June 2020). Available online: <https://www.ukradon.org/information/ukmaps>

RSK (2016). *Keadby Power Station, Preliminary Risk Assessment.*

Structural Soils (2016). *Interpretive Geotechnical Assessment on Ground Investigation.*

Structural Soils (2016). *Additional Geotechnical Reports.*

Structural Soils (2017). *Keadby Power Station, Geo-environmental Report.*

SSE (1999). *Keadby Power Station, Permitted Preliminary Works and Access Road, Discovery of Asbestos 11 September 1998 – Close Out Report.*

Trent and Peak Archaeology (2021). *A geoarchaeological hand auger survey at Keadby 3 Low Carbon Gas Power Station, Lincolnshire.*

Magnitude Surveys (2021). *Geophysical Survey Report for Keadby, North Lincolnshire.*

URS (2010). *Environmental Site Assessment.*

URS (2012). *SSE Keadby, High pH (Alkaline) Drainage Water Options Appraisal.*

URS (2018). *Design of a Site Protection and Monitoring Programme for Keadby Generation Ltd, Keadby Power Station.*

Wimtec Environmental Ltd (1998). *Scottish Hydro Electric Plc, Keadby 2 CCGT Development, Report on Ground Investigation*

Zetica (2020) *Risk Maps*. Available online: <https://zeticauxo.com/downloads-and-resources/risk-maps/>

6 Alpha Associates (DATE). *Preliminary UXO Threat Assessment.*

ANNEX A FIGURES

Figure 13A.1 - Site Location Plan

Figure 13A.2 - Site Layout Plan

Figure 13A.3 - Proposed Development Layout

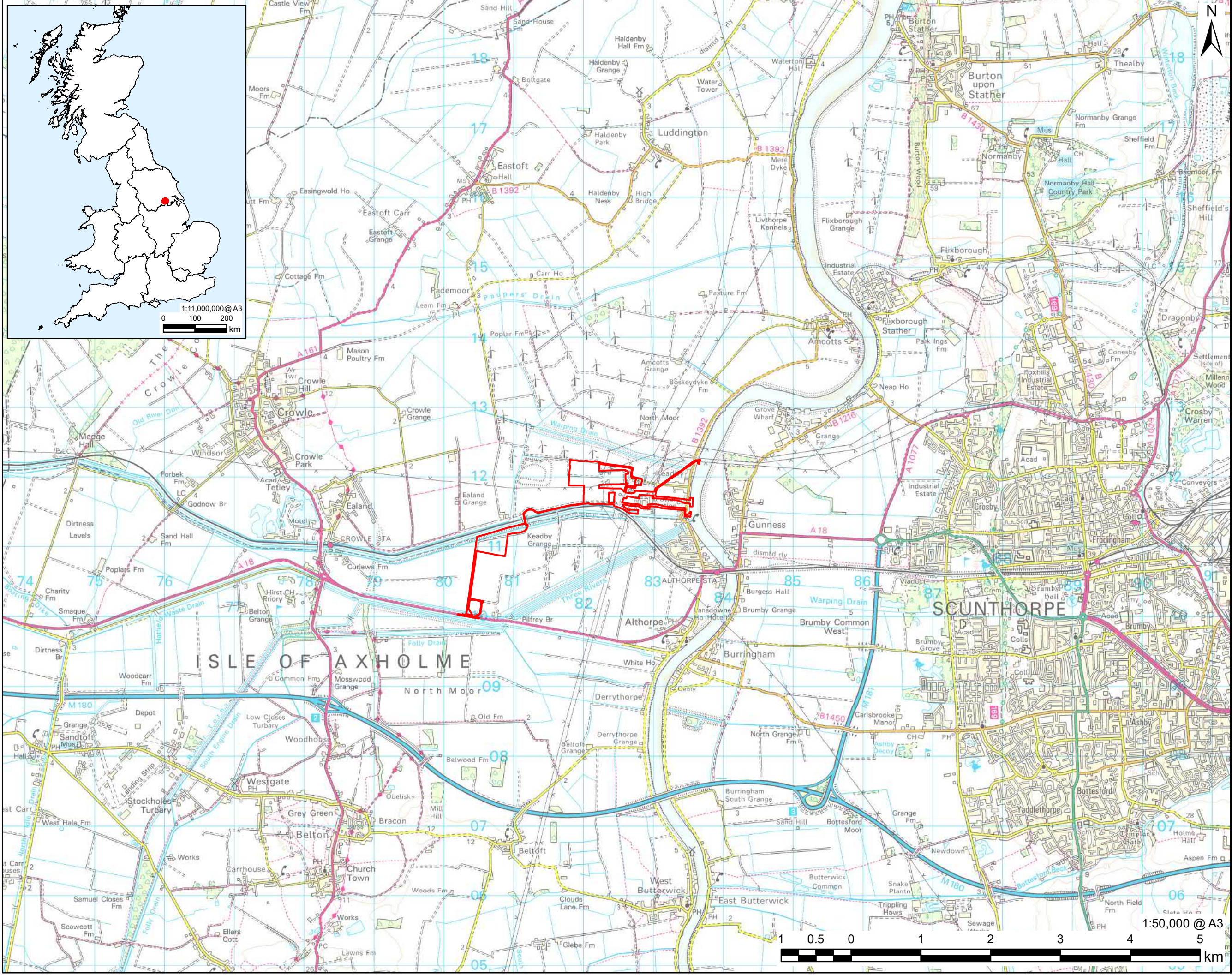

PROJECT
The Keadby 3 (Carbon Capture Equipped Gas Fired Generating Station) Order

APPLICANT
Keadby Generation Limited

CONSULTANT
AECOM Limited
2 City Walk
Leeds
LS11 9AR
T: 0113 391 6800
www.aecom.com

LEGEND
The Order Limits

NOTES
Reproduced from Ordnance Survey digital map data © Crown copyright 2021. All rights reserved. Licence number 0100031673.

ISSUE PURPOSE
ENVIRONMENTAL STATEMENT
PROJECT NUMBER
60625943
SHEET TITLE
Site Location Plan

SHEET NUMBER
Figure 13A.1

1:11,000,000@A3
0 100 200 km

1:50,000 @ A3

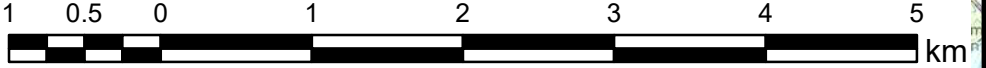

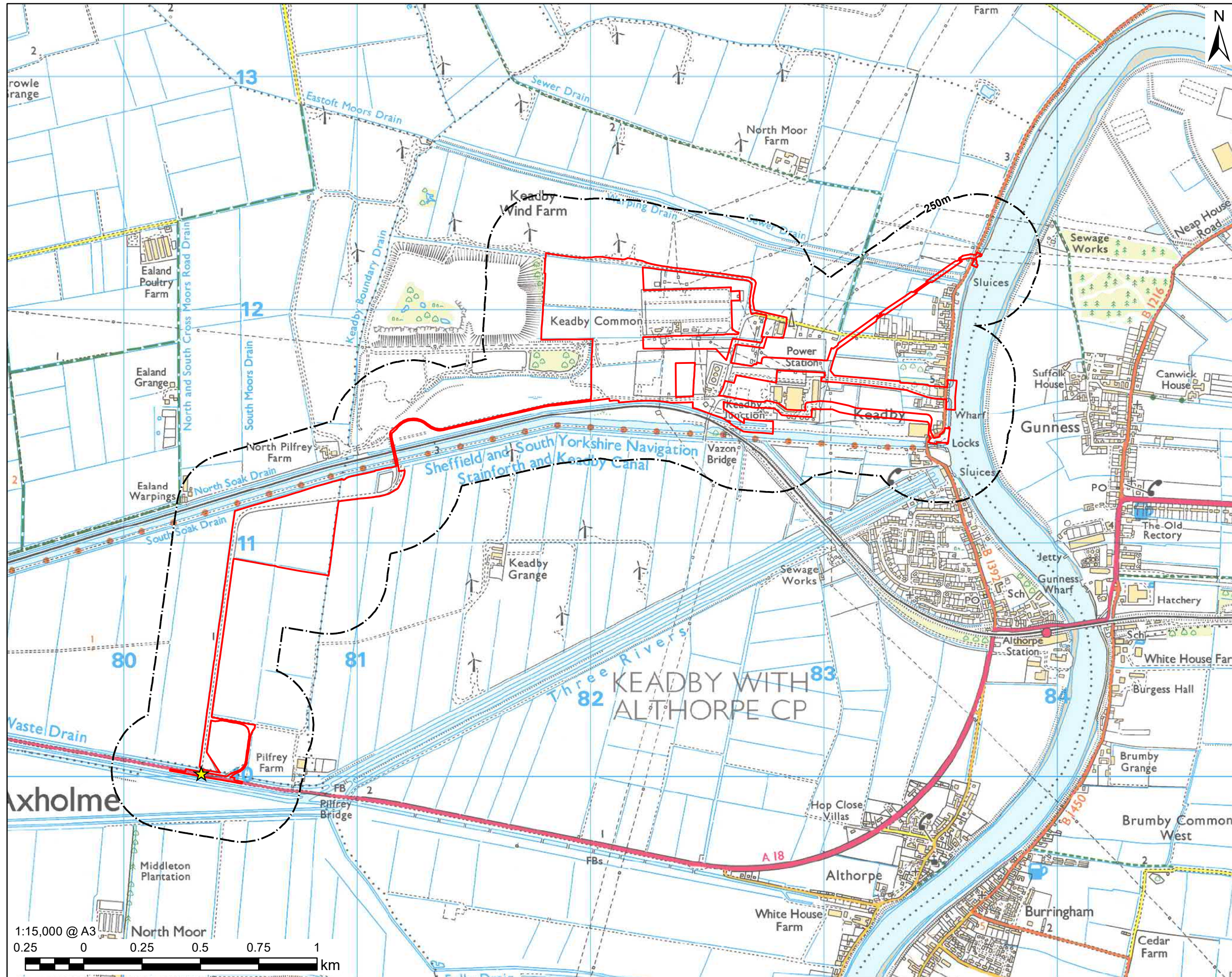

Filename: K:\07 CAD & GIS\02_Maps\Environmental Statement\Geology Hydrogeology and Land Contamination\Phase 1 Desk Study\K_ES_Fig13A_2_DCO_Site_A3_20210510_R01.mxd
Revision: 01
Drawn: JW Checked: CN Approved: RW Date: 19/05/2021

This drawing has been prepared for the use of AECOM's client. It may not be used, modified, reproduced or relied upon by third parties, except as agreed by AECOM or as required by law. AECOM accepts no responsibility for any liability whatsoever, to any party that uses or relies on this drawing without AECOM's express written consent. Do not scale this document. All measurements must be obtained from the stated dimensions.

LEGEND

[Red outline]	The Order Limits
[Red hatched]	Main Site
Indicative Area:	
[Green hatched]	Abstraction Option
[Yellow hatched]	Additional Abnormal Indivisible Load Route
[Black hatched]	Additional Land for Landscape and Biodiversity
[Purple hatched]	Construction and Operational Vehicular Site Access
[Brown hatched]	Electrical Connection Area to National Grid 400kV Substation
[Yellow hatched]	Emergency Vehicle Access Road
[Purple hatched]	Gas Above Ground Installation (AGI)
[Orange hatched]	Keadby 1
[Blue hatched]	Keadby 2
[Pink dotted]	Keadby 3 Construction Laydown Areas
[Red hatched]	Potential Electrical Connection to Northern Powergrid Substation
[Red hatched]	Proposed PCC Site
[Blue hatched]	Water Connection Corridor
[Yellow hatched]	Water Discharge Corridor
[Blue hatched]	Waterborne Transport Off-Loading Area
[Purple line]	Existing Gas Connection

NOTES
Reproduced from Ordnance Survey digital map data © Crown copyright 2021. All rights reserved. Licence number 0100031673. © National Grid UK

ISSUE PURPOSE
ENVIRONMENTAL STATEMENT
PROJECT NUMBER
60625943
SHEET TITLE
Indicative Work Areas Referred to in the Environmental Statement
SHEET NUMBER
Figure 13A.3

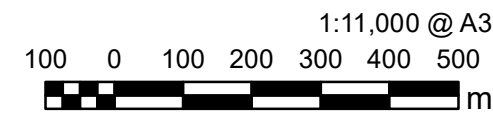
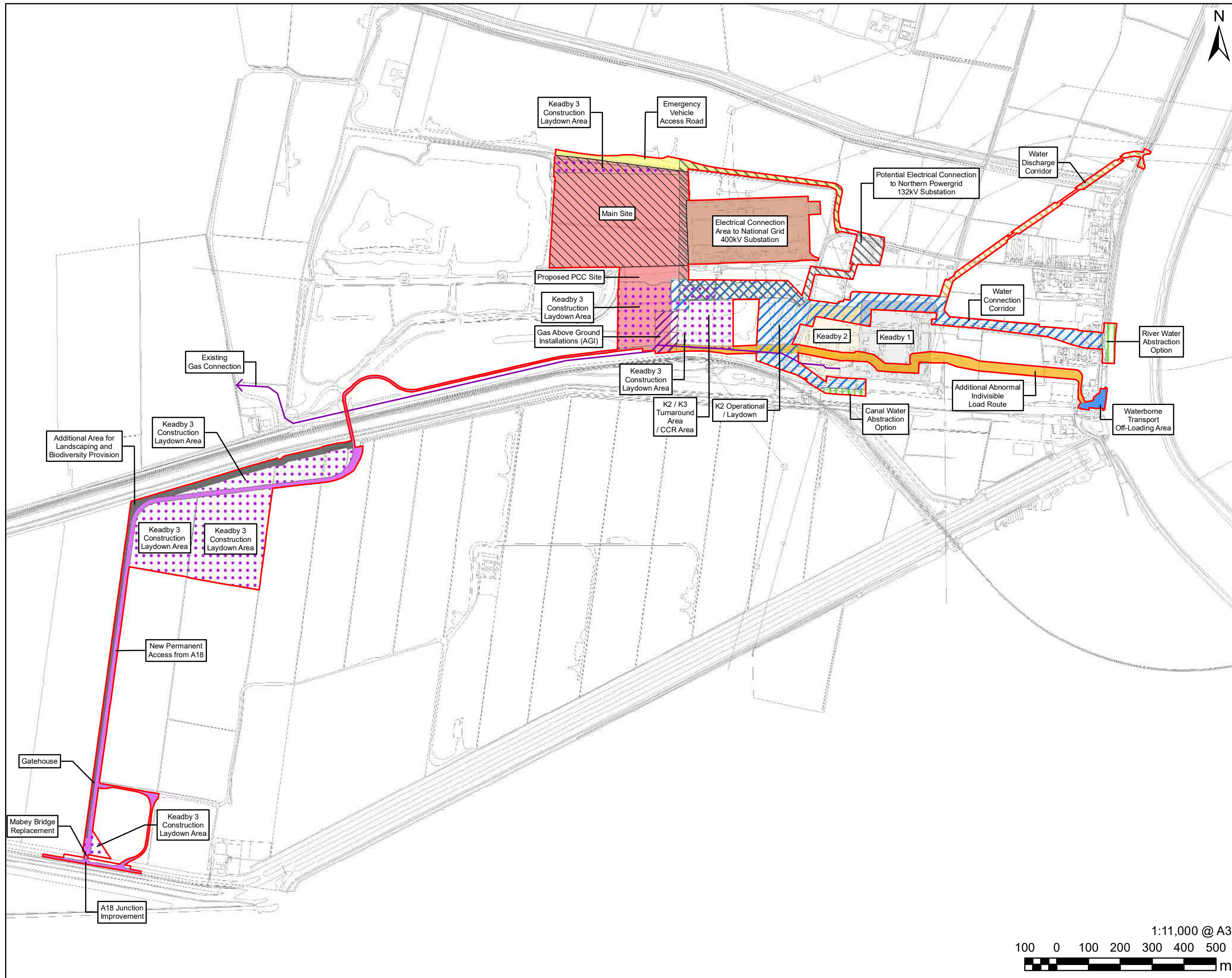

Filename: K:\07_CAD & GIS\02_Maps\Environmental Statement\Geology Hydrogeology and Land Contamination\Phase 1 Desk Study\K3_Site_Layout_A3_20210510_R01.mxd
Revision: 01
Drawn: JW Checked: CN Approved: RW Date: 13/05/2021

This drawing has been prepared for the use of AECOM's client. It may not be used, modified, reproduced or relied upon by third parties, except as agreed by AECOM or as required by law. AECOM accepts no responsibility and disclaims any liability whatsoever, to any party that uses or relies on this drawing without AECOM's express written consent. Do not scale this document. All measurements must be obtained from the stated dimensions.

Client Name: Keadby Generation Ltd		Site Name: Keadby 3 Low Carbon Gas Power Station Project	Project No. 60625943
Plate No. 1	Date: 16/07/2020		
Description: Temporary spoil storage (right) located on the southern portion of former agricultural land that encompasses both Keadby 3 CCGT and Keadby 3 CO2 Capture Plant. Northern portion of former agricultural land remains undeveloped (left).			

Plate No. 2	Date: 16/07/2020	
Description: Extensive vegetative cover noted in Keadby 3 Laydown and biodiversity area, with some areas of exposed ground.		

Client Name: Keadby Generation Ltd	Site Name: Keadby 3 Low Carbon Gas Power Station	Project No. 60625943
--	--	--------------------------------

Plate No. 3	Date: 16/07/2020
-----------------------	----------------------------

Description:
Example of fly tipped materials on Keadby 3 Indicative Laydown and Biodiversity area. Potential presence of ACM in areas.



Plate No. 4	Date: 16/07/2020
-----------------------	----------------------------

Description:
Cages of propane and butane gas cylinders noted adjacent to waste oil area.



Client Name: Keadby Generation Ltd	Site Name: Keadby 3 Low Carbon Gas Power Station	Project No. 60625943
--	--	--------------------------------

Plate No. 5	Date: 16/07/2020
-----------------------	----------------------------

Description:

Waste oil storage area with bunded water oil container, waste oil IBCs, barrels of insulating oils and smaller container of waste lubricating oil placed on concrete hardstanding.



Plate No. 6	Date: 16/07/2020
-----------------------	----------------------------

Description:

Five ASTs (above ground storage tanks) present in concrete bund adjacent to Keadby 1 Power Station site water treatment works. ASTs found to contain caustic soda, sulphuric acid and alum. Two of the ASTs were reportedly empty and previously contained sodium hypochlorite.



Client Name: Keadby Generation Ltd		Site Name: Keadby 3 Low Carbon Gas Power Station	Project No. 60625943
Plate No. 7	Date: 16/07/2020		
Description: <p>Two of the four large ASTs running along southern perimeter of Keadby 1 Power Station site, for storage of demineralised water.</p>			

Plate No. 8	Date: 16/07/2020	
Description: <p>One of the two diesel powered water pump contained within firefighting pump house.</p>		

Client Name: Keadby Generation Ltd		Site Name: Keadby 3 Low Carbon Gas Power Station	Project No. 60625943
Plate No. 9	Date: 16/07/2020		
Description: <p>Two gas heaters present to the south west of Keadby 1 Power Station site.</p>			

Plate No. 10	Date: 16/07/2020	
Description: <p>Four ASTs situated in concrete bunded adjacent to auxiliary boiler house. Two ASTs were for the storage of waste lubricating oil and two were for the storage of clean lubricating oil.</p>		

Client Name:
Keadby Generation Ltd

Site Name:
Keadby 3 Low Carbon Gas Power Station

Project No.
60625943

Plate No.
11

Date:
16/07/2020

Description:
Compound for the storage of liquid carbon dioxide in an AST (left) and storage of hydrogen gas cylinders (right).



Plate No.
12

Date:
16/07/2020

Description:
400kv transformers present to the north of Keadby 1 Power Station site.





Client Name: Keadby Generation Ltd		Site Name: Keadby 3 Low Carbon Gas Power Station	Project No. 60625943
Plate No. 13	Date: 16/07/2020		
Description: One of the two buildings housing emergency diesel generators, adjacent to the main boiler house at the centre of Keadby 1 Power Station site.			

Plate No. 14	Date: 16/07/2020	
Description: Waste area to the centre of Keadby 1 Power Station site. Contents including non-hazardous general waste, plastic recycling, small and large battery waste containers, cabinets storing empty chemical drums and WEEE, container for hazardous fluorescent tubes, hazardous lamp storage and empty and non-empty aerosol containers		

Client Name: Keadby Generation Ltd	Site Name: Keadby 3 Low Carbon Gas Power Station	Project No. 60625943
--	--	--------------------------------

Plate No. 15	Date: 16/07/2020
------------------------	----------------------------

Description:

Large AST containing distillate fuel oil to the north east of Keadby 1 Power Station site. AST contained within concrete bund.



Plate No. 16	Date: 16/07/2020
------------------------	----------------------------

Description:

Additional area containing oily waste, located adjacent to Large AST containing distillate fuel oil at north east of Keadby 1 Power Station site. Three IBCs noted to contain oily waste, whereas one was reported to contain glycol.



ANNEX B HISTORICAL MAPS PROVIDED BY ENVIROCHECK

Historical Mapping Legends

Ordnance Survey County Series 1:10,560

- Gravel Pit
- Sand Pit
- Other Pits
- Quarry
- Shingle
- Orchard
- Osiers
- Reeds
- Marsh
- Mixed Wood
- Deciduous
- Brushwood
- Fir
- Furze
- Rough Pasture
- Arrow denotes flow of water
- Trigonometrical Station
- Site of Antiquities
- Bench Mark
- Pump, Guide Post, Signal Post
- Well, Spring, Boundary Post
- 285** Surface Level
- Sketched Contour
- Instrumental Contour
- Main Roads
- Minor Roads
- Sunken Road
- Raised Road
- Road over Railway
- Railway over River
- Railway over Road
- Level Crossing
- Road over River or Canal
- Road over Stream
- Road over Stream
- County Boundary (Geographical)
- County & Civil Parish Boundary
- Administrative County & Civil Parish Boundary
- County Borough Boundary (England)
- County Burgh Boundary (Scotland)
- Rural District Boundary
- Civil Parish Boundary

Ordnance Survey Plan 1:10,000

- Chalk Pit, Clay Pit or Quarry
- Gravel Pit
- Sand Pit
- Disused Pit or Quarry
- Refuse or Slag Heap
- Lake, Loch or Pond
- Dunes
- Boulders
- Coniferous Trees
- Non-Coniferous Trees
- Orchard
- Scrub
- Coppice
- Bracken
- Heath
- Rough Grassland
- Marsh
- Reeds
- Saltings
- Building
- Glasshouse
- Sloping Masonry
- Pylon
- Electricity Transmission Line
- Pole
- Cutting
- Embankment
- Standard Gauge Multiple Track
- Standard Gauge Single Track
- Siding, Tramway or Mineral Line
- Narrow Gauge
- Geographical County
- Administrative County, County Borough or County of City
- Municipal Borough, Urban or Rural District, Burgh or District Council
- Borough, Burgh or County Constituency
- Civil Parish
- BP, BS Boundary Post or Stone
- Ch Church
- CH Club House
- F E Sta Fire Engine Station
- FB Foot Bridge
- Fn Fountain
- GP Guide Post
- MP Mile Post
- MS Mile Stone
- Pol Sta Police Station
- PO Post Office
- PC Public Convenience
- PH Public House
- SB Signal Box
- Spr Spring
- TCB Telephone Call Box
- TCP Telephone Call Post
- W Well

1:10,000 Raster Mapping

- Gravel Pit
- Rock
- Boulders
- Shingle
- Sand
- Slopes
- General detail
- Overhead detail
- Multi-track railway
- County boundary (England only)
- District, Unitary, Metropolitan, London Borough boundary
- Area of wooded vegetation
- Non-coniferous trees
- Coniferous trees
- Orchard
- Rough Grassland
- Scrub
- Water feature
- MHW(S) Mean high water (springs)
- Telephone line (where shown)
- Bench mark (where shown)
- Point feature (e.g. Guide Post or Mile Stone)
- Site of antiquity
- General Building
- Refuse tip or slag heap
- Rock (scattered)
- Boulders (scattered)
- Mud
- Sand Pit
- Top of cliff
- Underground detail
- Narrow gauge railway
- Single track railway
- Civil, parish or community boundary
- Constituency boundary
- Non-coniferous trees
- Coniferous trees
- Positioned tree
- Coppice or Osiers
- Heath
- Marsh, Salt Marsh or Reeds
- Flow arrows
- MLW(S) Mean low water (springs)
- Electricity transmission line (with poles)
- Triangulation station
- Pylon, flare stack or lighting tower
- Glasshouse
- Important Building



Historical Mapping & Photography included:

Mapping Type	Scale	Date	Pg
Yorkshire	1:10,560	1854	2
Lincolnshire	1:10,560	1885 - 1886	3
Yorkshire	1:10,560	1894	4
Lincolnshire	1:10,560	1907 - 1908	5
Lincolnshire	1:10,560	1938 - 1950	6
Lincolnshire	1:10,560	1951	7
Lincolnshire	1:10,560	1951	8
Ordnance Survey Plan	1:10,000	1956	9
Ordnance Survey Plan	1:10,000	1969	10
Ordnance Survey Plan	1:10,000	1987	11
10K Raster Mapping	1:10,000	2000	12
10K Raster Mapping	1:10,000	2006	13
VectorMap Local	1:10,000	2020	14

Historical Map - Slice A

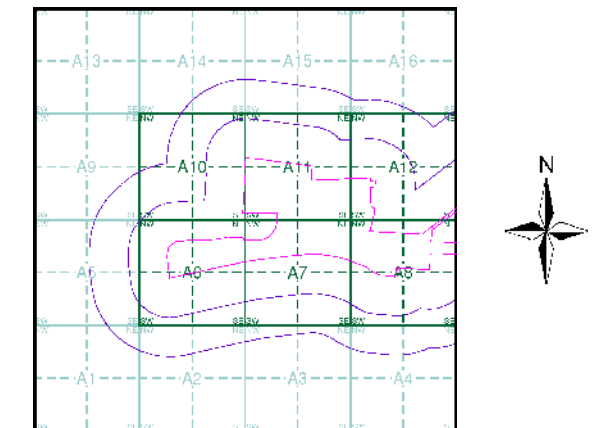

Order Details

Order Number: 242986885_1_1
 Customer Ref: 60625943
 National Grid Reference: 482060, 411790
 Slice: A
 Site Area (Ha): 68.12
 Search Buffer (m): 500

Site Details

Keadby



Tel: 0844 844 9952
 Fax: 0844 844 9951
 Web: www.envirocheck.co.uk



Yorkshire

Published 1854

Source map scale - 1:10,560

The historical maps shown were reproduced from maps predominantly held at the scale adopted for England, Wales and Scotland in the 1840's. In 1854 the 1:2,500 scale was adopted for mapping urban areas; these maps were used to update the 1:10,560 maps. The published date given therefore is often some years later than the surveyed date. Before 1938, all OS maps were based on the Cassini Projection, with independent surveys of a single county or group of counties, giving rise to significant inaccuracies in outlying areas. In the late 1940's, a Provisional Edition was produced, which updated the 1:10,560 mapping from a number of sources. The maps appear unfinished - with all military camps and other strategic sites removed. These maps were initially overprinted with the National Grid. In 1970, the first 1:10,000 maps were produced using the Transverse Mercator Projection. The revision process continued until recently, with new editions appearing every 10 years or so for urban areas.

Map Name(s) and Date(s)

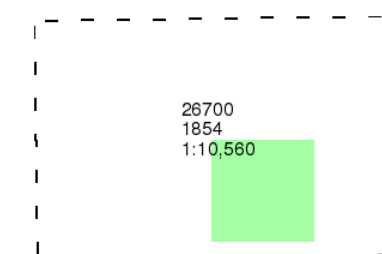

Historical Map - Slice A

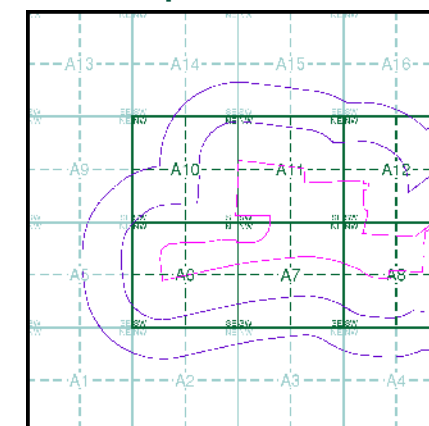

Order Details

Order Number: 242986885_1_1
Customer Ref: 60625943
National Grid Reference: 482060, 411790
Slice: A
Site Area (Ha): 68.12
Search Buffer (m): 500

Site Details

Keadby



Tel: 0844 844 9952
Fax: 0844 844 9951
Web: www.envirocheck.co.uk

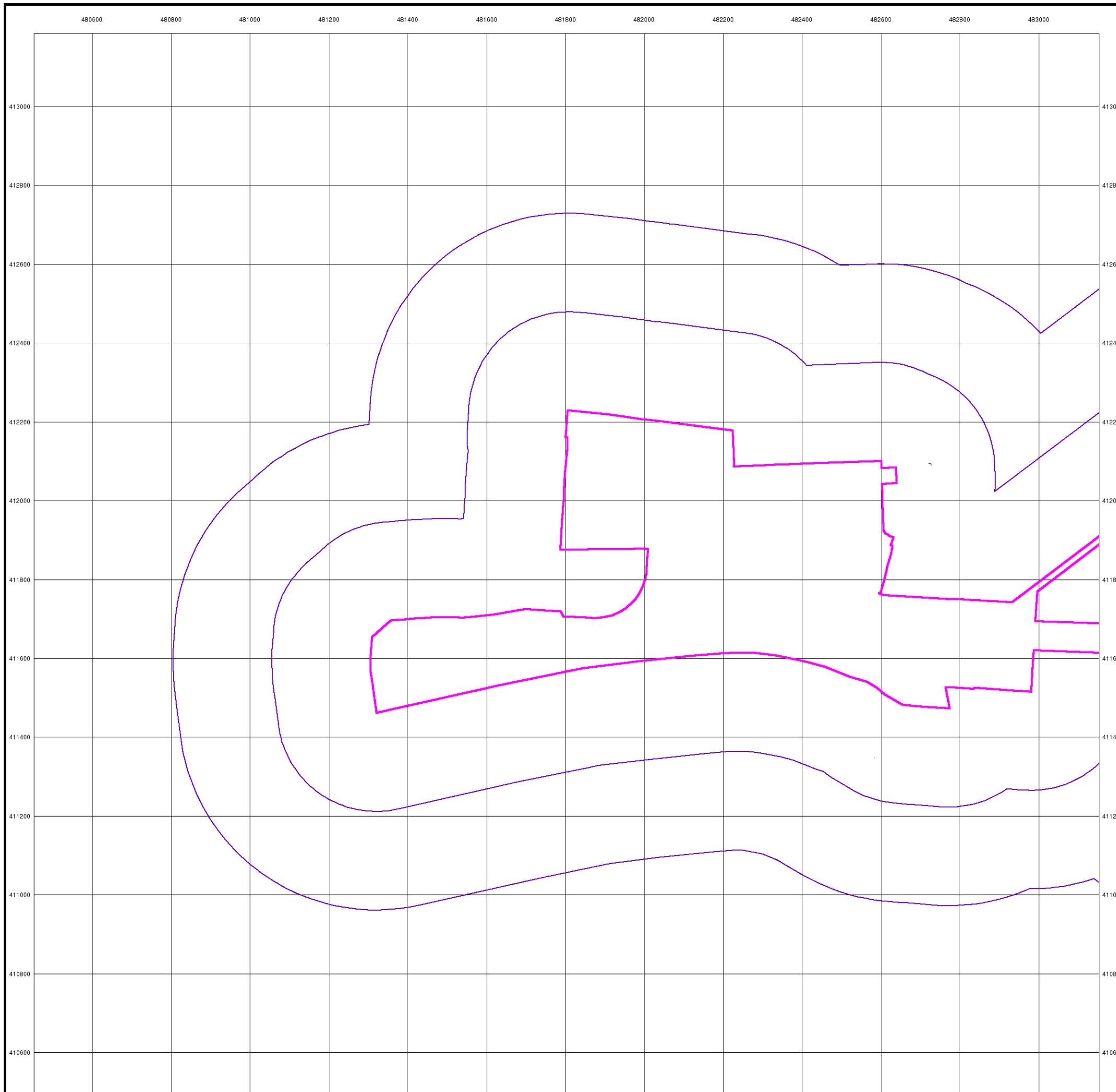



Lincolnshire

Published 1885 - 1886

Source map scale - 1:10,560

The historical maps shown were reproduced from maps predominantly held at the scale adopted for England, Wales and Scotland in the 1840's. In 1854 the 1:2,500 scale was adopted for mapping urban areas; these maps were used to update the 1:10,560 maps. The published date given therefore is often some years later than the surveyed date. Before 1938, all OS maps were based on the Cassini Projection, with independent surveys of a single county or group of counties, giving rise to significant inaccuracies in outlying areas. In the late 1940's, a Provisional Edition was produced, which updated the 1:10,560 mapping from a number of sources. The maps appear unfinished - with all military camps and other strategic sites removed. These maps were initially overprinted with the National Grid. In 1970, the first 1:10,000 maps were produced using the Transverse Mercator Projection. The revision process continued until recently, with new editions appearing every 10 years or so for urban areas.

Map Name(s) and Date(s)

009SE 1885 1:10,560	010SW 1886 1:10,560
017NE 1885 1:10,560	018NW 1886 1:10,560

Historical Map - Slice A

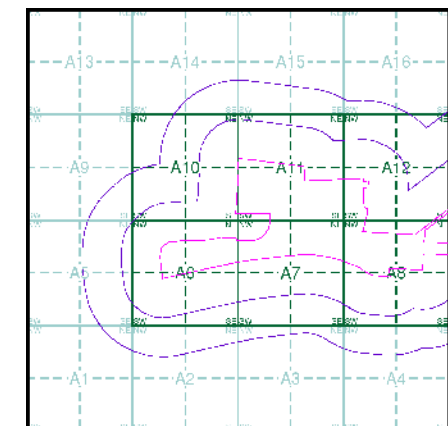

Order Details

Order Number: 242986885_1_1
 Customer Ref: 60625943
 National Grid Reference: 482060, 411790
 Slice: A
 Site Area (Ha): 68.12
 Search Buffer (m): 500

Site Details

Keadby



Tel: 0844 844 9952
 Fax: 0844 844 9951
 Web: www.envirocheck.co.uk

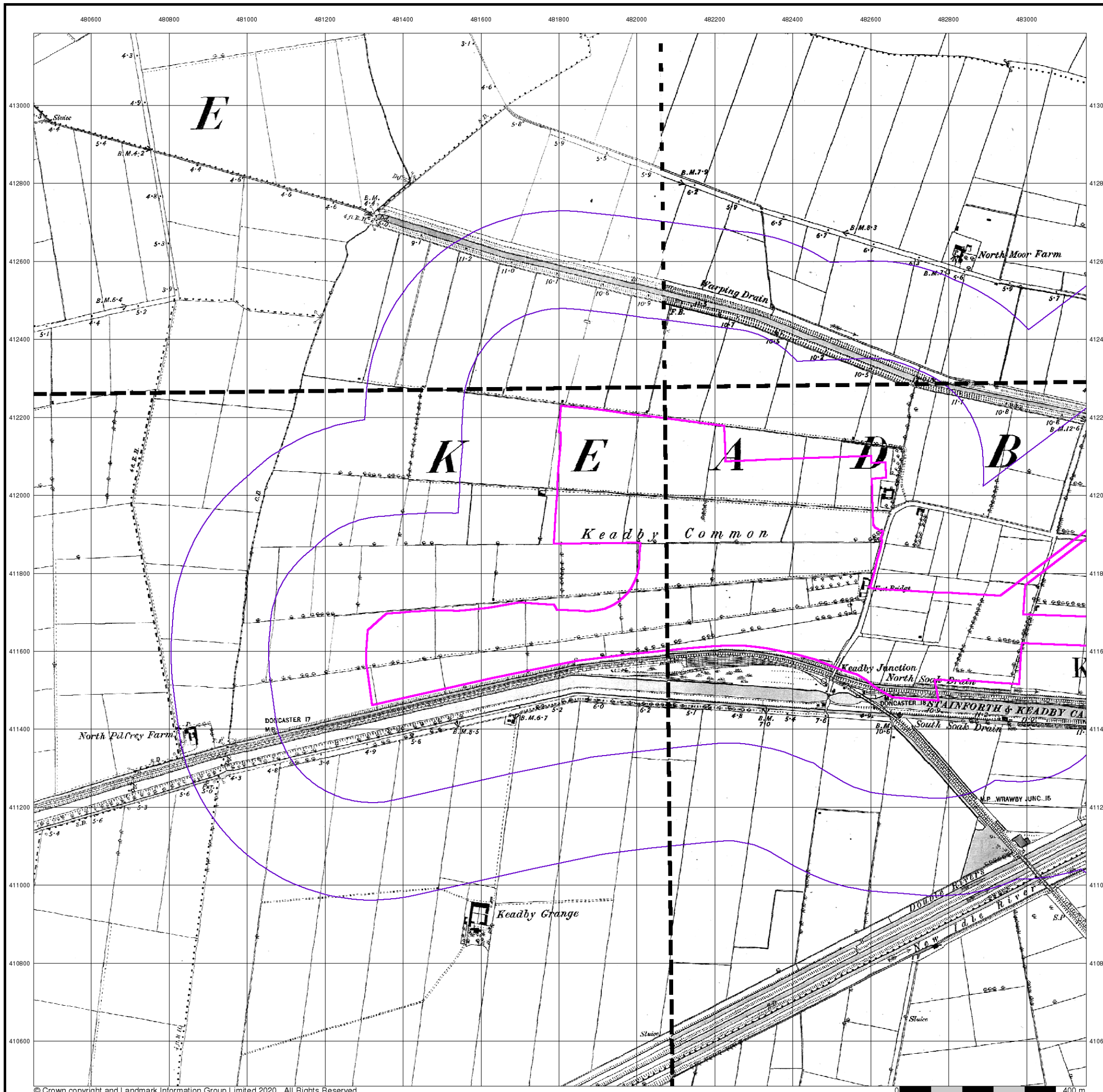



Yorkshire

Published 1894

Source map scale - 1:10,560

The historical maps shown were reproduced from maps predominantly held at the scale adopted for England, Wales and Scotland in the 1840's. In 1854 the 1:2,500 scale was adopted for mapping urban areas; these maps were used to update the 1:10,560 maps. The published date given therefore is often some years later than the surveyed date. Before 1938, all OS maps were based on the Cassini Projection, with independent surveys of a single county or group of counties, giving rise to significant inaccuracies in outlying areas. In the late 1940's, a Provisional Edition was produced, which updated the 1:10,560 mapping from a number of sources. The maps appear unfinished - with all military camps and other strategic sites removed. These maps were initially overprinted with the National Grid. In 1970, the first 1:10,000 maps were produced using the Transverse Mercator Projection. The revision process continued until recently, with new editions appearing every 10 years or so for urban areas.

Map Name(s) and Date(s)

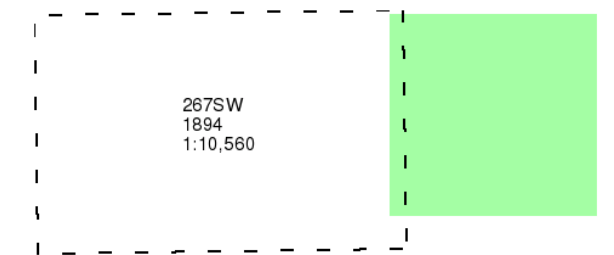

Historical Map - Slice A

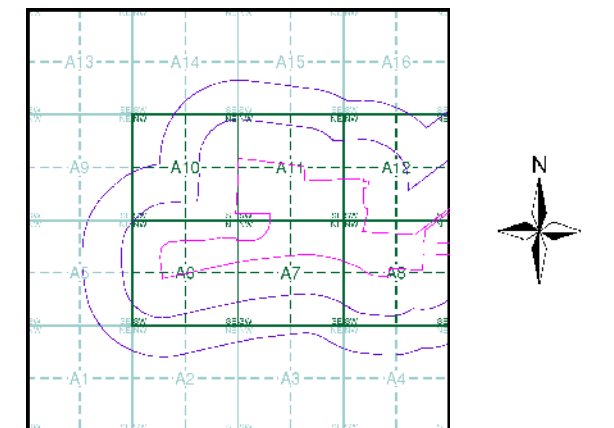

Order Details

Order Number: 242986885_1_1
Customer Ref: 60625943
National Grid Reference: 482060, 411790
Slice: A
Site Area (Ha): 68.12
Search Buffer (m): 500

Site Details

Keadby



Tel: 0844 844 9952
Fax: 0844 844 9951
Web: www.envirocheck.co.uk

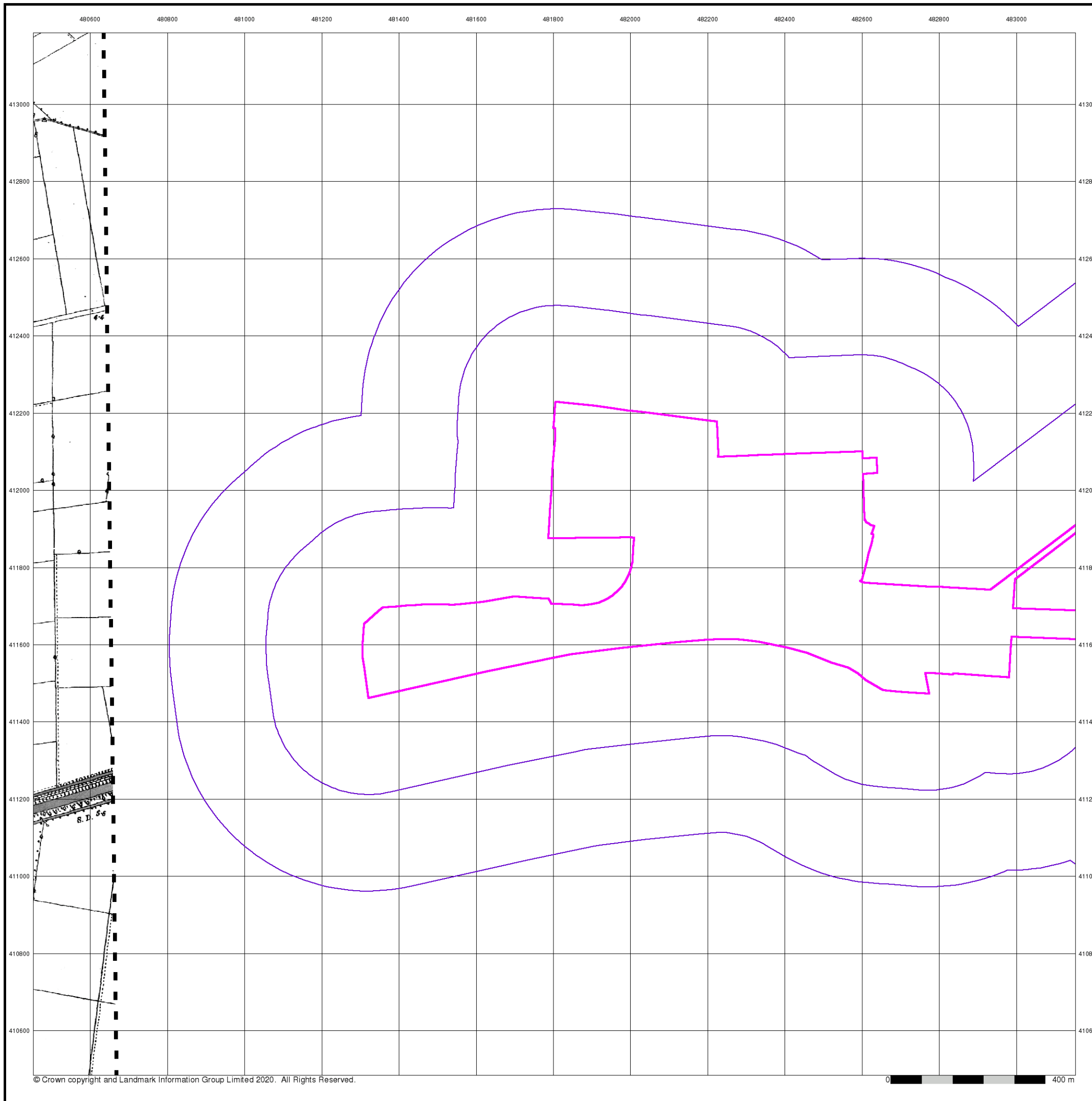



Lincolnshire

Published 1907 - 1908

Source map scale - 1:10,560

The historical maps shown were reproduced from maps predominantly held at the scale adopted for England, Wales and Scotland in the 1840's. In 1854 the 1:2,500 scale was adopted for mapping urban areas; these maps were used to update the 1:10,560 maps. The published date given therefore is often some years later than the surveyed date. Before 1938, all OS maps were based on the Cassini Projection, with independent surveys of a single county or group of counties, giving rise to significant inaccuracies in outlying areas. In the late 1940's, a Provisional Edition was produced, which updated the 1:10,560 mapping from a number of sources. The maps appear unfinished - with all military camps and other strategic sites removed. These maps were initially overprinted with the National Grid. In 1970, the first 1:10,000 maps were produced using the Transverse Mercator Projection. The revision process continued until recently, with new editions appearing every 10 years or so for urban areas.

Map Name(s) and Date(s)

009SE 1908 1:10,560	010SW 1908 1:10,560
017NE 1908 1:10,560	018NW 1907 1:10,560

Historical Map - Slice A

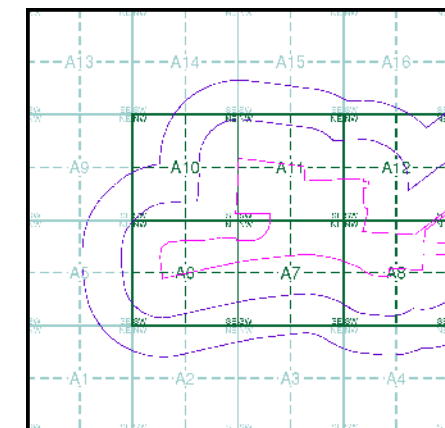

Order Details

Order Number: 242986885_1_1
 Customer Ref: 60625943
 National Grid Reference: 482060, 411790
 Slice: A
 Site Area (Ha): 68.12
 Search Buffer (m): 500

Site Details

Keadby



Tel: 0844 844 9952
 Fax: 0844 844 9951
 Web: www.envirocheck.co.uk

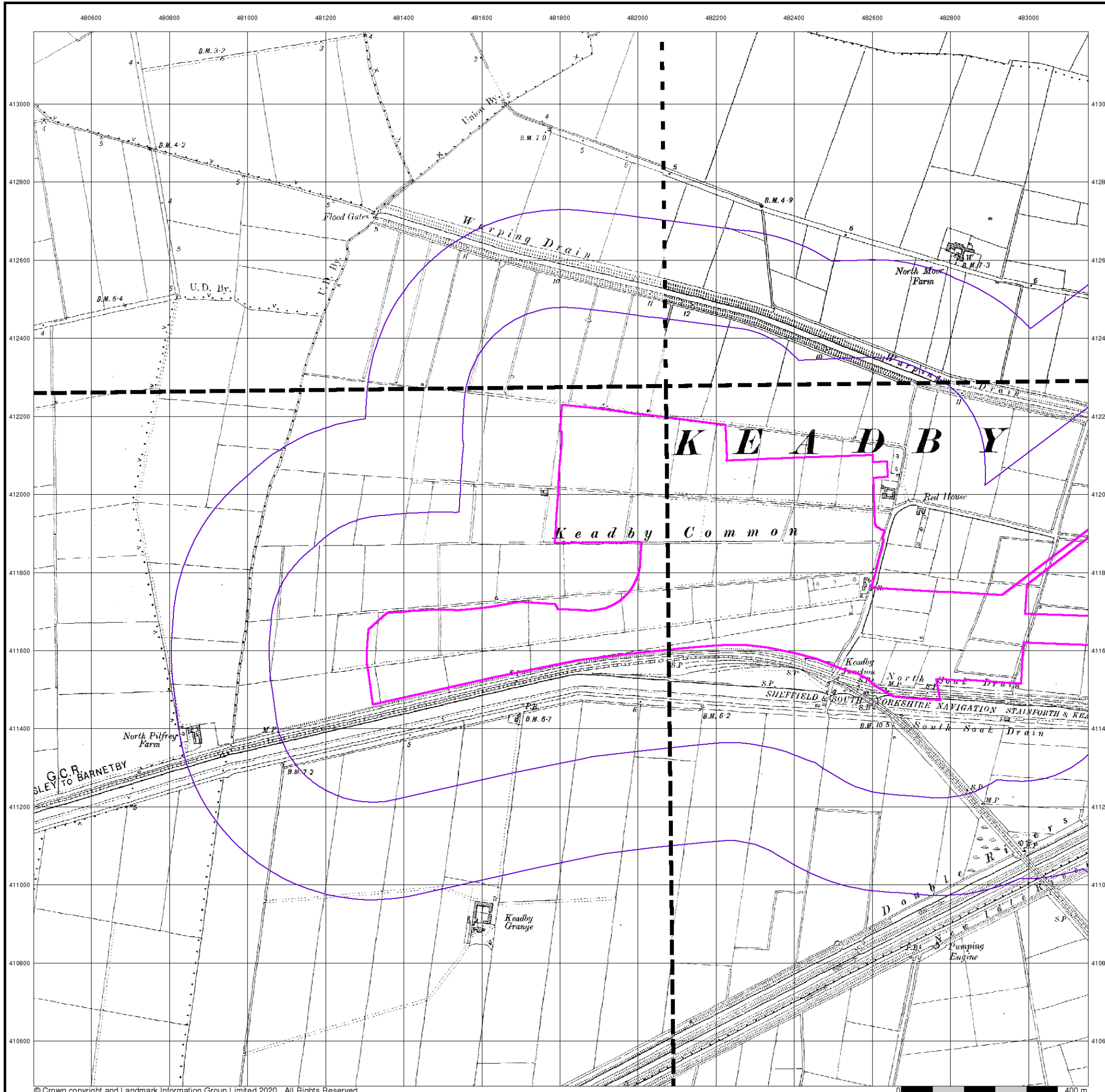



Lincolnshire

Published 1938 - 1950

Source map scale - 1:10,560

The historical maps shown were reproduced from maps predominantly held at the scale adopted for England, Wales and Scotland in the 1840's. In 1854 the 1:2,500 scale was adopted for mapping urban areas; these maps were used to update the 1:10,560 maps. The published date given therefore is often some years later than the surveyed date. Before 1938, all OS maps were based on the Cassini Projection, with independent surveys of a single county or group of counties, giving rise to significant inaccuracies in outlying areas. In the late 1940's, a Provisional Edition was produced, which updated the 1:10,560 mapping from a number of sources. The maps appear unfinished - with all military camps and other strategic sites removed. These maps were initially overprinted with the National Grid. In 1970, the first 1:10,000 maps were produced using the Transverse Mercator Projection. The revision process continued until recently, with new editions appearing every 10 years or so for urban areas.

Map Name(s) and Date(s)

009SE 1946 1:10,560	010SW 1946 1:10,560
017NE 1950 1:10,560	018NW 1938 1:10,560

Historical Map - Slice A

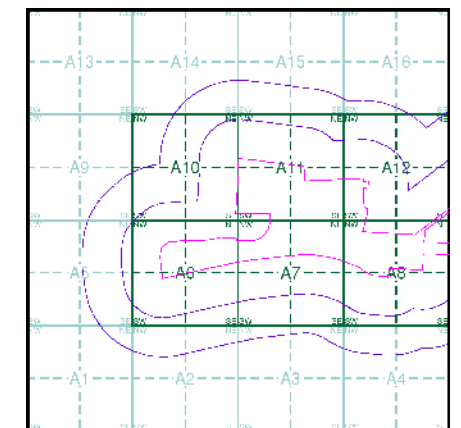

Order Details

Order Number: 242986885_1_1
 Customer Ref: 60625943
 National Grid Reference: 482060, 411790
 Slice: A
 Site Area (Ha): 68.12
 Search Buffer (m): 500

Site Details

Keadby



Tel: 0844 844 9952
 Fax: 0844 844 9951
 Web: www.envirocheck.co.uk

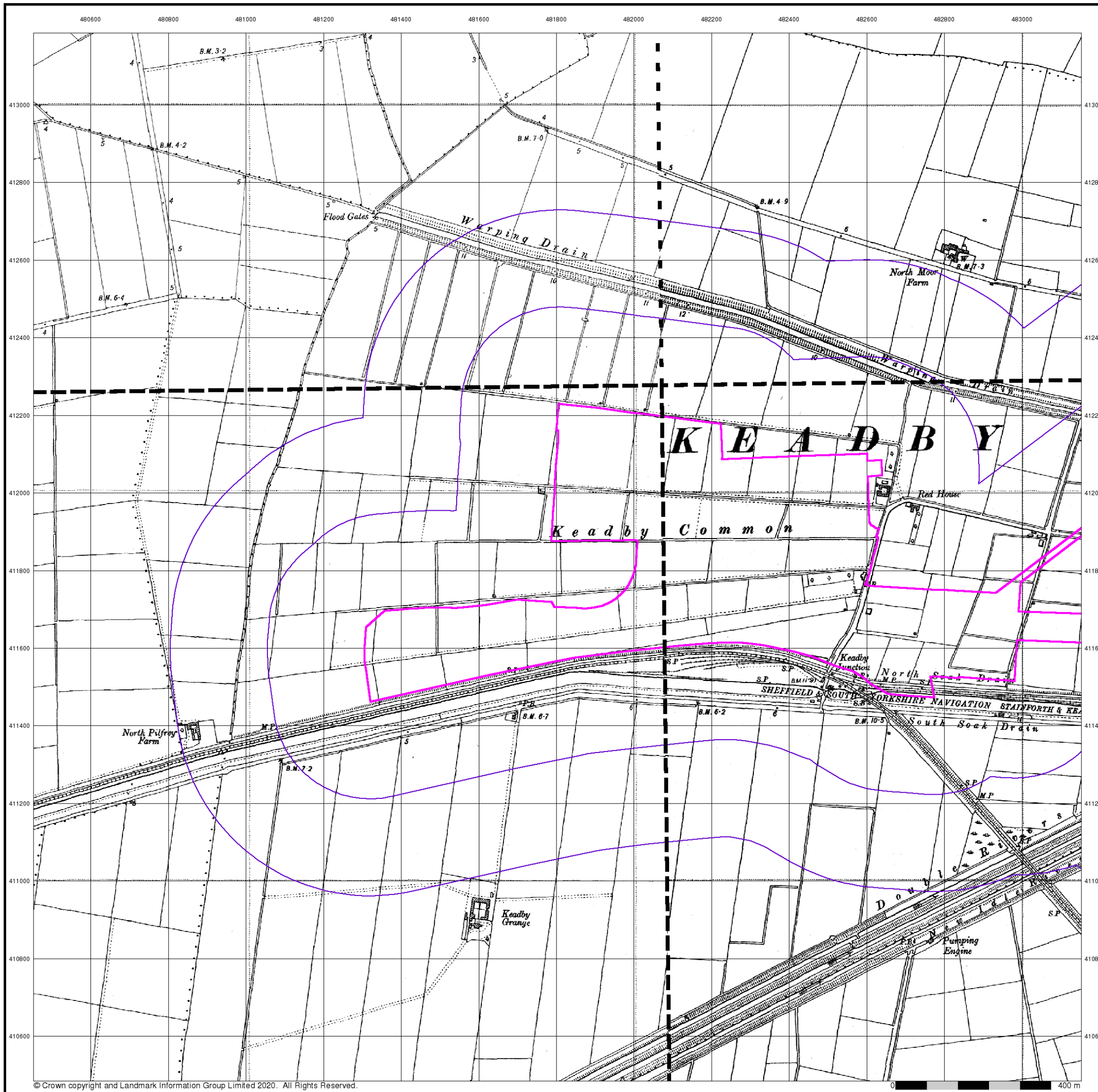

480600 480800 481000 481200 481400 481600 481800 482000 482200 482400 482600 482800 483000

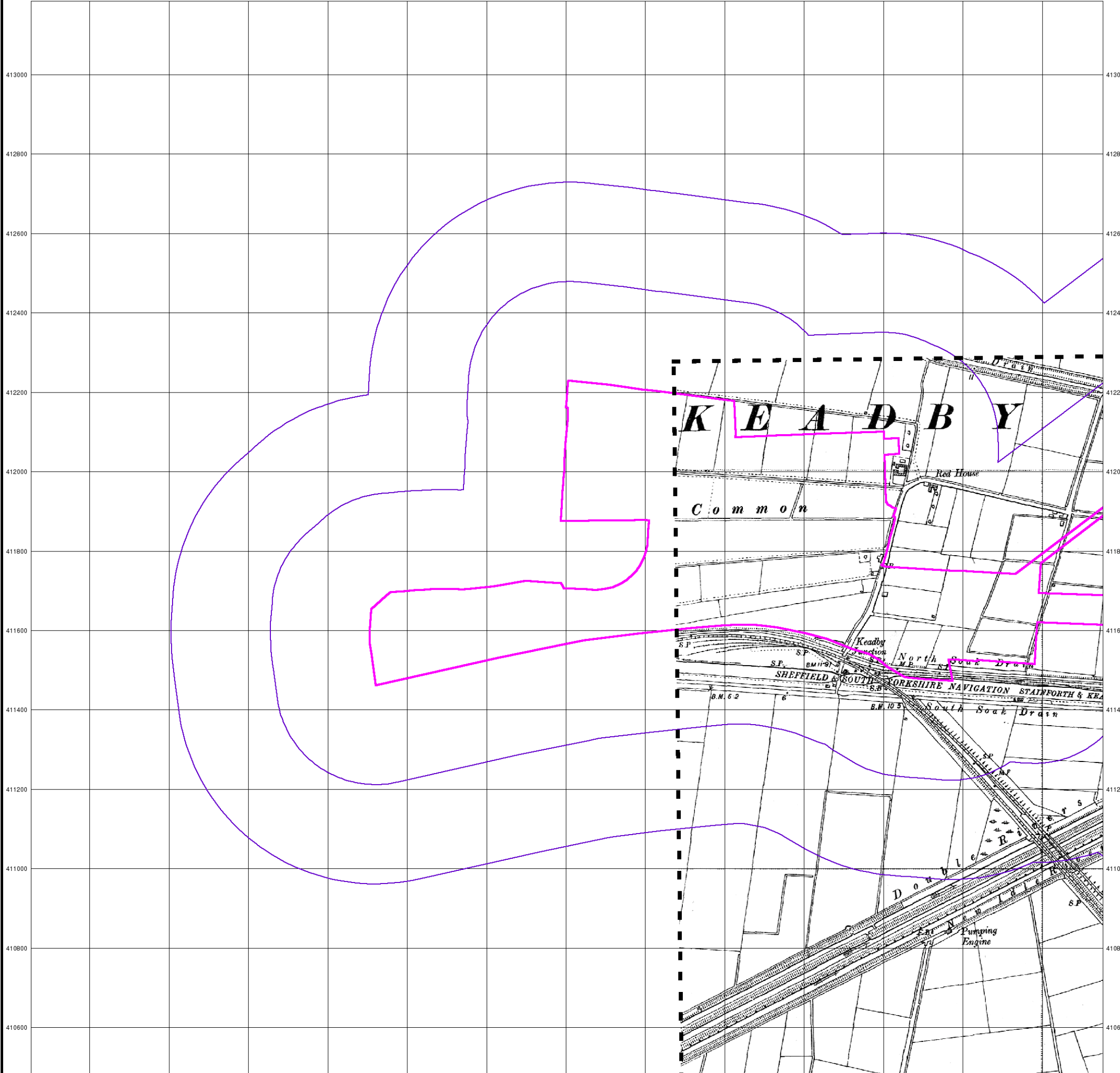

Lincolnshire

Published 1951

Source map scale - 1:10,560

The historical maps shown were reproduced from maps predominantly held at the scale adopted for England, Wales and Scotland in the 1840's. In 1854 the 1:2,500 scale was adopted for mapping urban areas; these maps were used to update the 1:10,560 maps. The published date given therefore is often some years later than the surveyed date. Before 1938, all OS maps were based on the Cassini Projection, with independent surveys of a single county or group of counties, giving rise to significant inaccuracies in outlying areas. In the late 1940's, a Provisional Edition was produced, which updated the 1:10,560 mapping from a number of sources. The maps appear unfinished - with all military camps and other strategic sites removed. These maps were initially overprinted with the National Grid. In 1970, the first 1:10,000 maps were produced using the Transverse Mercator Projection. The revision process continued until recently, with new editions appearing every 10 years or so for urban areas.

Map Name(s) and Date(s)

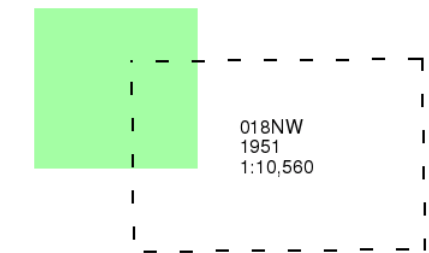

Historical Map - Slice A

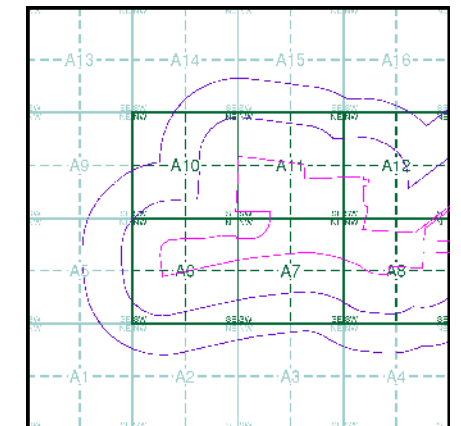

Order Details

Order Number: 242986885_1_1
 Customer Ref: 60625943
 National Grid Reference: 482060, 411790
 Slice: A
 Site Area (Ha): 68.12
 Search Buffer (m): 500

Site Details

Keadby



Tel: 0844 844 9952
 Fax: 0844 844 9951
 Web: www.envirocheck.co.uk

480600 480800 481000 481200 481400 481600 481800 482000 482200 482400 482600 482800 483000



Lincolnshire

Published 1951

Source map scale - 1:10,560

The historical maps shown were reproduced from maps predominantly held at the scale adopted for England, Wales and Scotland in the 1840's. In 1854 the 1:2,500 scale was adopted for mapping urban areas; these maps were used to update the 1:10,560 maps. The published date given therefore is often some years later than the surveyed date. Before 1938, all OS maps were based on the Cassini Projection, with independent surveys of a single county or group of counties, giving rise to significant inaccuracies in outlying areas. In the late 1940's, a Provisional Edition was produced, which updated the 1:10,560 mapping from a number of sources. The maps appear unfinished - with all military camps and other strategic sites removed. These maps were initially overprinted with the National Grid. In 1970, the first 1:10,000 maps were produced using the Transverse Mercator Projection. The revision process continued until recently, with new editions appearing every 10 years or so for urban areas.

Map Name(s) and Date(s)

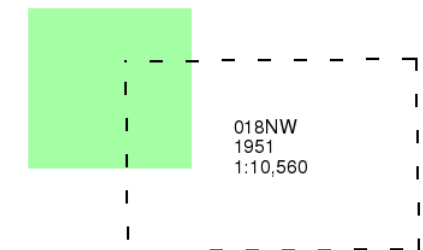

Historical Map - Slice A

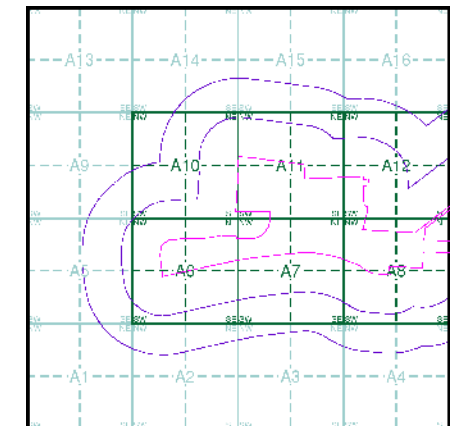

Order Details

Order Number: 242986885_1_1
Customer Ref: 60625943
National Grid Reference: 482060, 411790
Slice: A
Site Area (Ha): 68.12
Search Buffer (m): 500

Site Details

Keadby



Tel: 0844 844 9952
Fax: 0844 844 9951
Web: www.envirocheck.co.uk

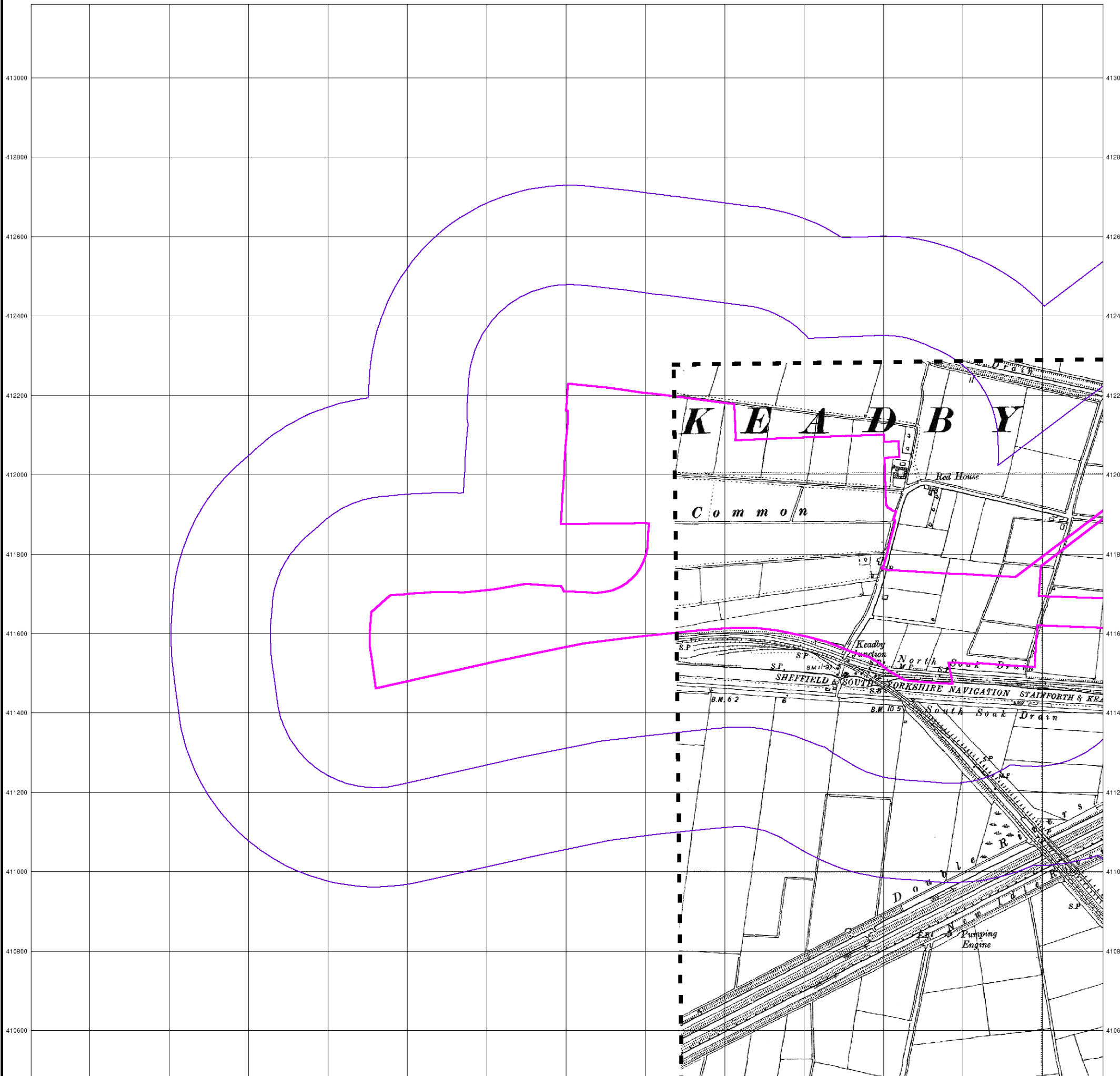



Ordnance Survey Plan

Published 1956

Source map scale - 1:10,000

The historical maps shown were reproduced from maps predominantly held at the scale adopted for England, Wales and Scotland in the 1840's. In 1854 the 1:2,500 scale was adopted for mapping urban areas; these maps were used to update the 1:10,560 maps. The published date given therefore is often some years later than the surveyed date. Before 1938, all OS maps were based on the Cassini Projection, with independent surveys of a single county or group of counties, giving rise to significant inaccuracies in outlying areas. In the late 1940's, a Provisional Edition was produced, which updated the 1:10,560 mapping from a number of sources. The maps appear unfinished - with all military camps and other strategic sites removed. These maps were initially overprinted with the National Grid. In 1970, the first 1:10,000 maps were produced using the Transverse Mercator Projection. The revision process continued until recently, with new editions appearing every 10 years or so for urban areas.

Map Name(s) and Date(s)

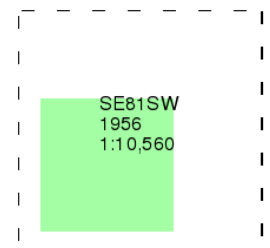

Historical Map - Slice A

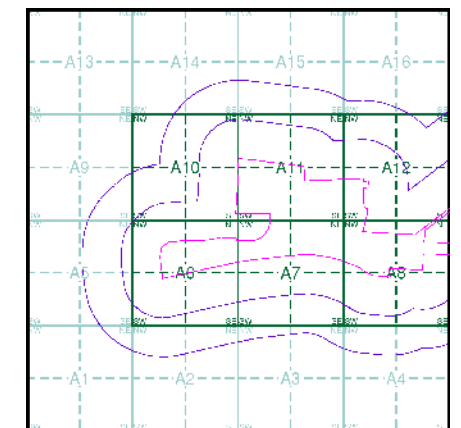

Order Details

Order Number: 242986885_1_1
Customer Ref: 60625943
National Grid Reference: 482060, 411790
Slice: A
Site Area (Ha): 68.12
Search Buffer (m): 500

Site Details

Keadby



Tel: 0844 844 9952
Fax: 0844 844 9951
Web: www.envirocheck.co.uk

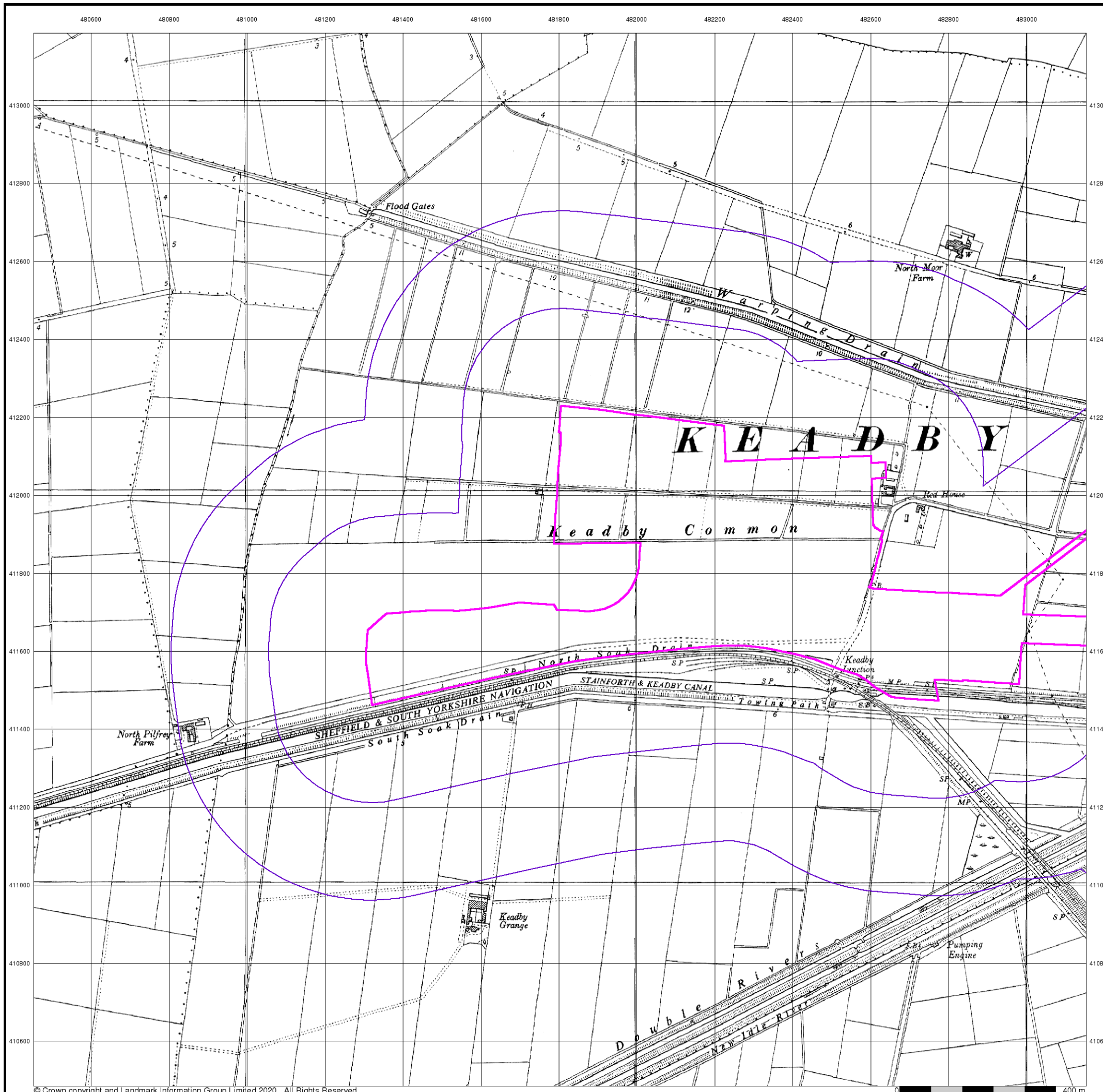



Ordnance Survey Plan

Published 1969

Source map scale - 1:10,000

The historical maps shown were reproduced from maps predominantly held at the scale adopted for England, Wales and Scotland in the 1840's. In 1854 the 1:2,500 scale was adopted for mapping urban areas; these maps were used to update the 1:10,560 maps. The published date given therefore is often some years later than the surveyed date. Before 1938, all OS maps were based on the Cassini Projection, with independent surveys of a single county or group of counties, giving rise to significant inaccuracies in outlying areas. In the late 1940's, a Provisional Edition was produced, which updated the 1:10,560 mapping from a number of sources. The maps appear unfinished - with all military camps and other strategic sites removed. These maps were initially overprinted with the National Grid. In 1970, the first 1:10,000 maps were produced using the Transverse Mercator Projection. The revision process continued until recently, with new editions appearing every 10 years or so for urban areas.

Map Name(s) and Date(s)

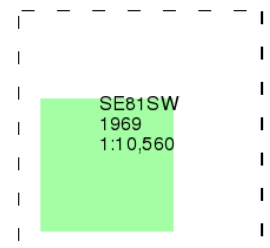

Historical Map - Slice A

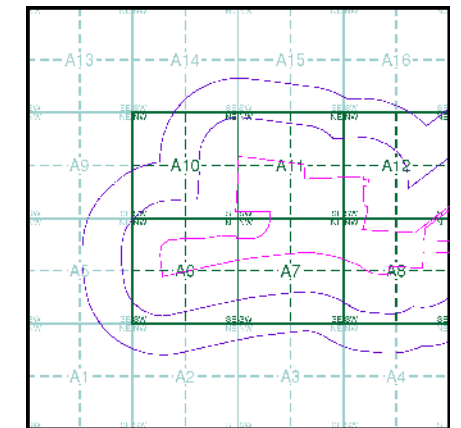

Order Details

Order Number:	242986885_1_1
Customer Ref:	60625943
National Grid Reference:	482060, 411790
Slice:	A
Site Area (Ha):	68.12
Search Buffer (m):	500

Site Details

Keadby



Tel:	0844 844 9952
Fax:	0844 844 9951
Web:	www.envirocheck.co.uk





Ordnance Survey Plan

Published 1987

Source map scale - 1:10,000

The historical maps shown were reproduced from maps predominantly held at the scale adopted for England, Wales and Scotland in the 1840's. In 1854 the 1:2,500 scale was adopted for mapping urban areas; these maps were used to update the 1:10,560 maps. The published date given therefore is often some years later than the surveyed date. Before 1938, all OS maps were based on the Cassini Projection, with independent surveys of a single county or group of counties, giving rise to significant inaccuracies in outlying areas. In the late 1940's, a Provisional Edition was produced, which updated the 1:10,560 mapping from a number of sources. The maps appear unfinished - with all military camps and other strategic sites removed. These maps were initially overprinted with the National Grid. In 1970, the first 1:10,000 maps were produced using the Transverse Mercator Projection. The revision process continued until recently, with new editions appearing every 10 years or so for urban areas.

Map Name(s) and Date(s)

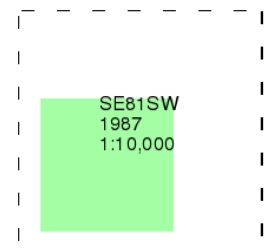

Historical Map - Slice A

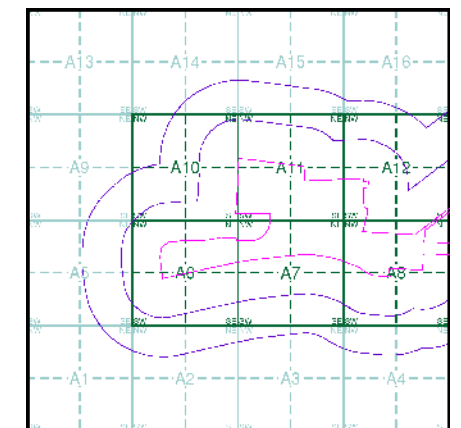

Order Details

Order Number:	242986885_1_1
Customer Ref:	60625943
National Grid Reference:	482060, 411790
Slice:	A
Site Area (Ha):	68.12
Search Buffer (m):	500

Site Details

Keadby



Tel:	0844 844 9952
Fax:	0844 844 9951
Web:	www.envirocheck.co.uk

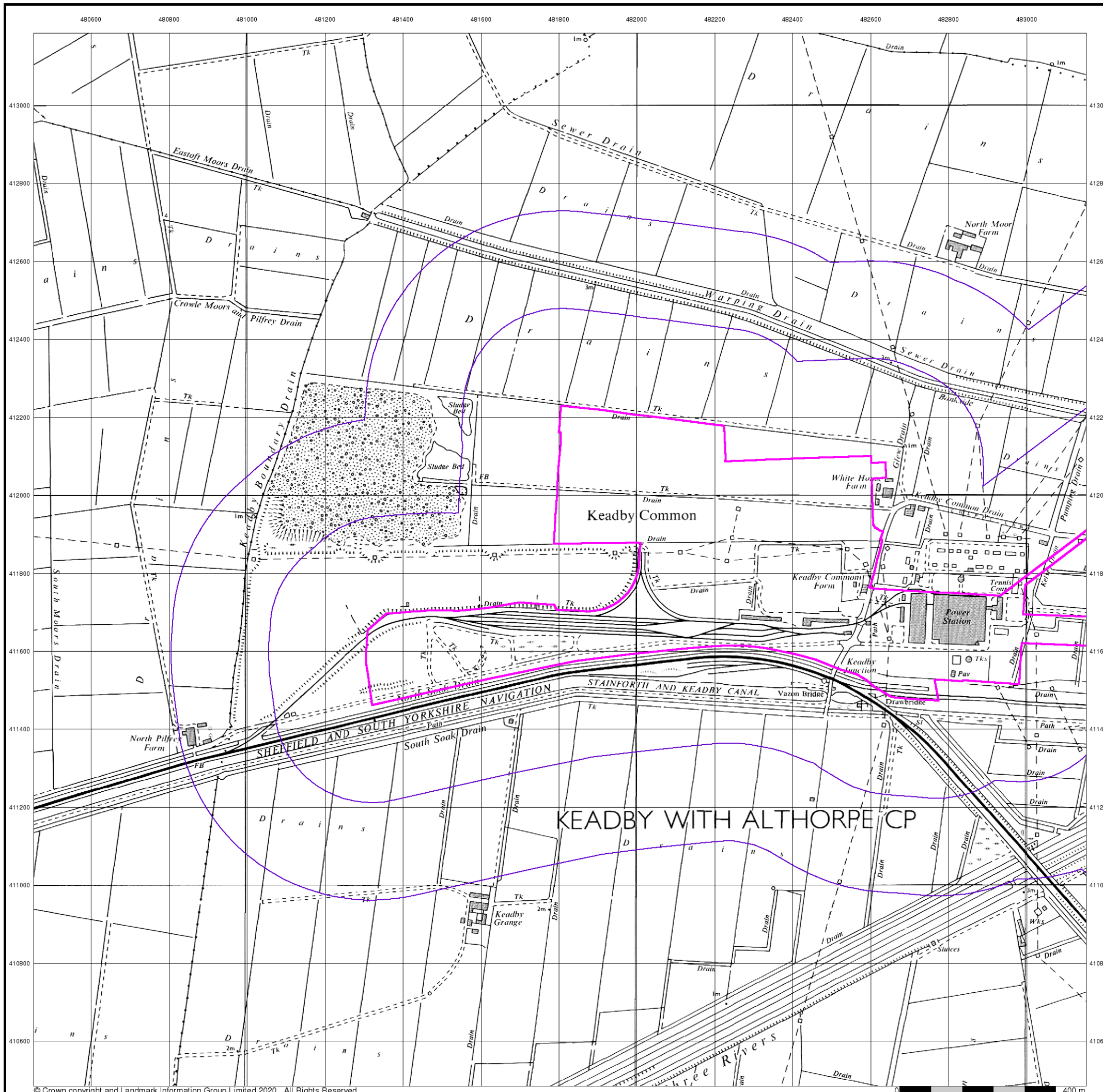



10k Raster Mapping

Published 2000

Source map scale - 1:10,000

The historical maps shown were produced from the Ordnance Survey's 1:10,000 colour raster mapping. These maps are derived from Landplan which replaced the old 1:10,000 maps originally published in 1970. The data is highly detailed showing buildings, fences and field boundaries as well as all roads, tracks and paths. Road names are also included together with the relevant road number and classification. Boundary information depiction includes county, unitary authority, district, civil parish and constituency.

Map Name(s) and Date(s)

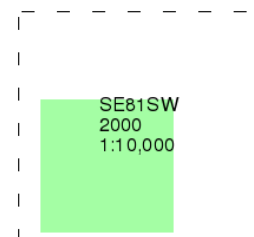

Historical Map - Slice A

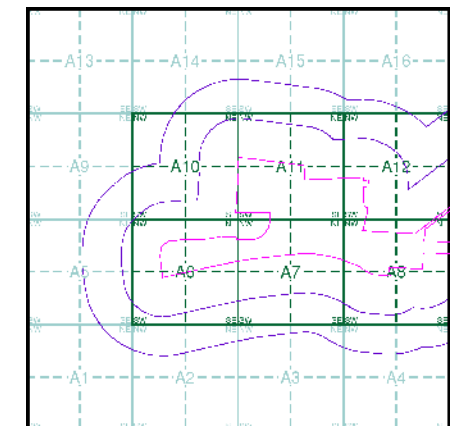

Order Details

Order Number:	242986885_1_1
Customer Ref:	60625943
National Grid Reference:	482060, 411790
Slice:	A
Site Area (Ha):	68.12
Search Buffer (m):	500

Site Details

Keadby



Tel:	0844 844 9952
Fax:	0844 844 9951
Web:	www.envirocheck.co.uk





10k Raster Mapping

Published 2006

Source map scale - 1:10,000

The historical maps shown were produced from the Ordnance Survey's 1:10,000 colour raster mapping. These maps are derived from Landplan which replaced the old 1:10,000 maps originally published in 1970. The data is highly detailed showing buildings, fences and field boundaries as well as all roads, tracks and paths. Road names are also included together with the relevant road number and classification. Boundary information depiction includes county, unitary authority, district, civil parish and constituency.

Map Name(s) and Date(s)

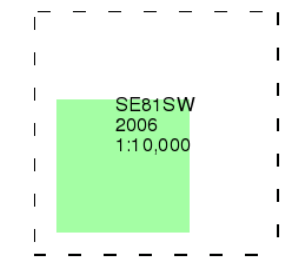

Historical Map - Slice A

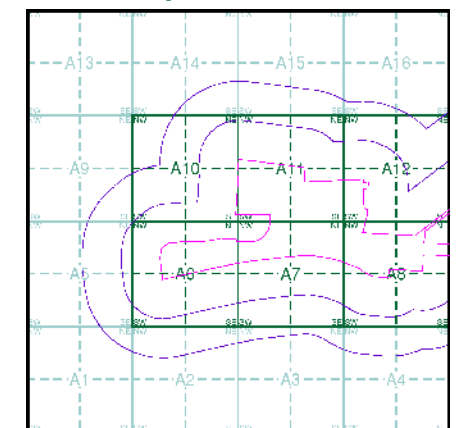

Order Details

Order Number:	242986885_1_1
Customer Ref:	60625943
National Grid Reference:	482060, 411790
Slice:	A
Site Area (Ha):	68.12
Search Buffer (m):	500

Site Details

Keadby



Tel:	0844 844 9952
Fax:	0844 844 9951
Web:	www.envirocheck.co.uk

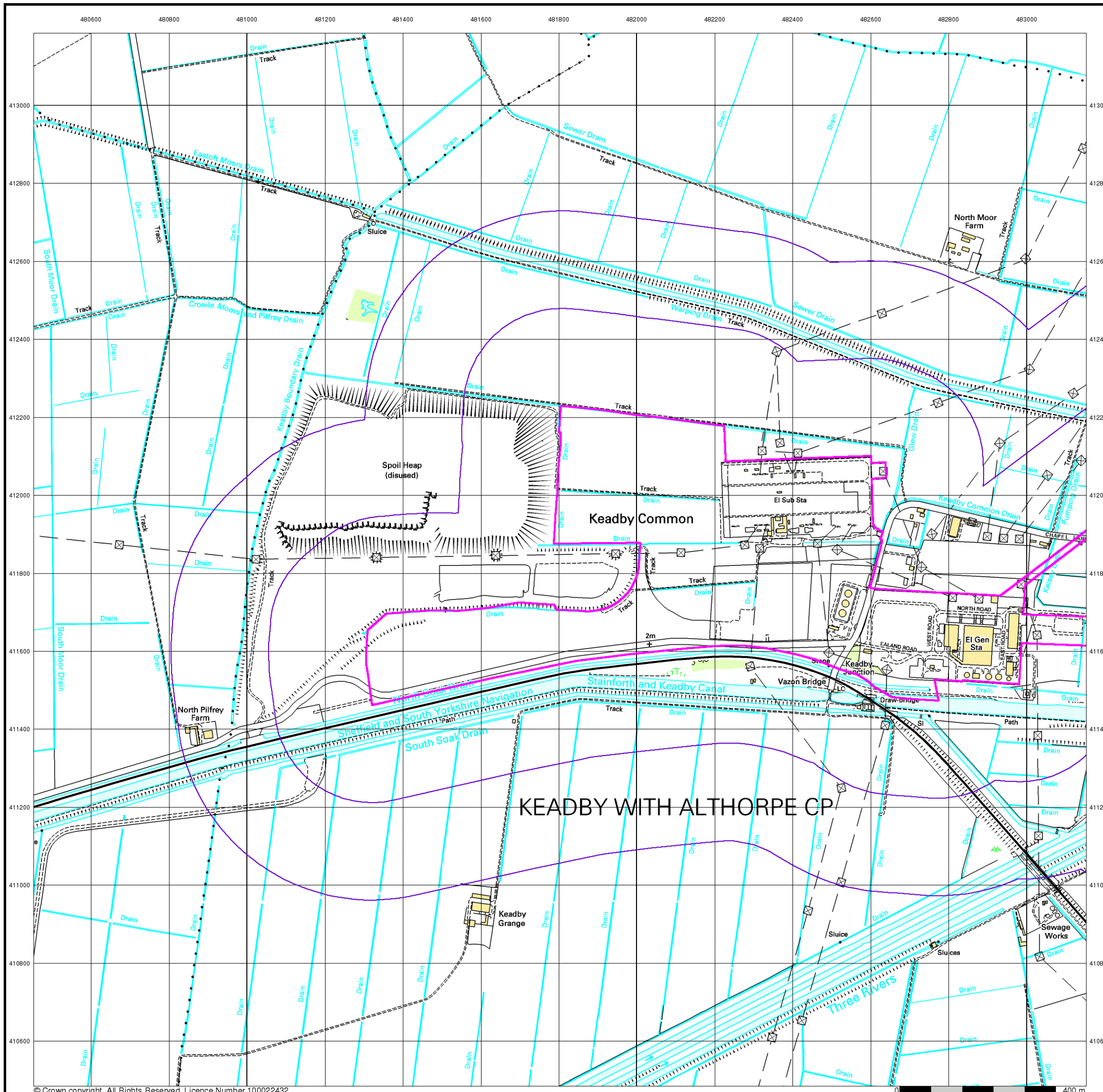

© Crown copyright. All Rights Reserved. Licence Number 100022432.



VectorMap Local

Published 2020

Source map scale - 1:10,000

VectorMap Local (Raster) is Ordnance Survey's highest detailed 'backdrop' mapping product. These maps are produced from OS's VectorMap Local, a simple vector dataset at a nominal scale of 1:10,000, covering the whole of Great Britain, that has been designed for creating graphical mapping. OS VectorMap Local is derived from large-scale information surveyed at 1:1250 scale (covering major towns and cities), 1:2500 scale (smaller towns, villages and developed rural areas), and 1:10 000 scale (mountain, moorland and river estuary areas).

Map Name(s) and Date(s)

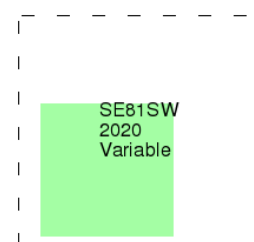

Historical Map - Slice A

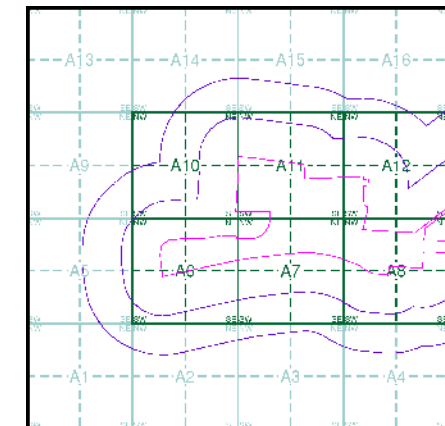

Order Details

Order Number:	242986885_1_1
Customer Ref:	60625943
National Grid Reference:	482060, 411790
Slice:	A
Site Area (Ha):	68.12
Search Buffer (m):	500

Site Details

Keadby



Tel: 0844 844 9952
 Fax: 0844 844 9951
 Web: www.envirocheck.co.uk

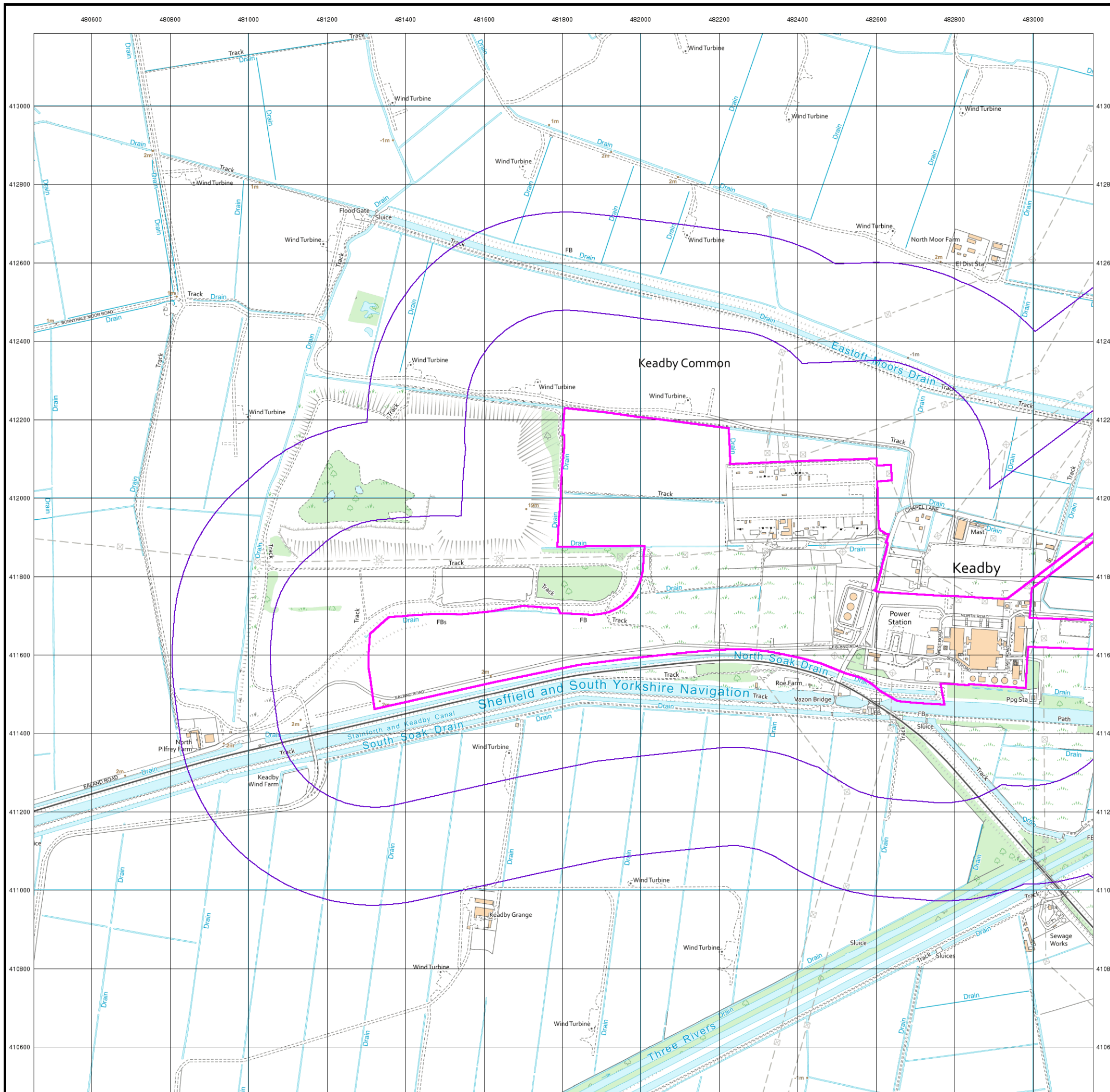

Historical Mapping Legends

Ordnance Survey County Series and Ordnance Survey Plan 1:2,500

Quarry **Gravel Pit** **Sand Pit**
Clay Pit **Shingle** **Refuse Heap**
Sloping Masonry **Flat Rock**
Marsh **Reeds** **Osiers**
Rough Pasture **Furze** **Wood**
Mixed Wood **Brushwood** **Orchard**
Fir **Ford** **Stepping Stones**
Ferry **Waterfall** **Lock**
Trig. Station **Altitude at Trig. Station**
B.M. 325.9 **Bench Mark** **Surface Level**
Arrow denotes flow of water **Antiquities (site of)**
Cutting **Embankment**
Railway crossing Road **Level Crossing** **Road crossing Railway**
Railway crossing River or Canal **Road over single stream** **Road over River or Canal**
County Boundary (Geographical)
County & Civil Parish Boundary
Administrative County & Civil Parish Boundary
County Borough Boundary (England)
Co. Boro. Bdy.
County Burgh Boundary (Scotland)
Co. Burgh Bdy.
BP BS Boundary Post or Stone **P.C.B** Police Call Box
B.R. Bridle Road **P** Pump
E.P Electricity Pylon **S.P** Signal Post
F.B. Foot Bridge **SL** Sluice
F.P. Foot Path **Sp.** Spring
G.P Guide Post or Board **T.C.B** Telephone Call Box
M.S Mile Stone **Tr.** Trough
M.P M.R Mooring Post or Ring **W** Well

Ordnance Survey Plan, Additional SIMs and Supply of Unpublished Survey Information 1:2,500 and 1:1,250

Inactive Quarry, Chalk Pit or Clay Pit **Active Quarry, Chalk Pit or Clay Pit**
Rock **Boulders**
Cliff **Slopes** **Top**
Roofed Building **Glazed Roof Building**
Sloping Masonry **Archway**
Non-Coniferous Tree (surveyed) **Coniferous Tree (surveyed)**
Non-Coniferous Trees (not surveyed) **Coniferous Trees (not surveyed)**
Orchard Tree **Scrub** **Bracken**
Coppice, Osier **Reeds** **Marsh, Saltings**
Rough Grassland **Heath** **Culvert**
Direction of water flow **Bench Mark** **Antiquity (site of)**
Cave Entrance **Triangulation Station** **Electricity Pylon**
Electricity Transmission Line
County Boundary (Geographical)
County & Civil Parish Boundary
Civil Parish Boundary
Admin. County or County Bor. Boundary
London Borough Boundary
Symbol marking point where boundary mereing changes
BH Beer House **P** Pillar, Pole or Post
BP, BS Boundary Post or Stone **PO** Post Office
Cn, C Capstan, Crane **PC** Public Convenience
Chy Chimney **PH** Public House
D Fn Drinking Fountain **Pp** Pump
EI P Electricity Pillar or Post **SB, S Br** Signal Box or Bridge
FAP Fire Alarm Pillar **SP, SL** Signal Post or Light
FB Foot Bridge **Spr** Spring
GP Guide Post **Tk** Tank or Track
H Hydrant or Hydraulic **TCB** Telephone Call Box
LC Level Crossing **TCP** Telephone Call Post
MH Manhole **Tr** Trough
MP Mile Post or Mooring Post **Wr Pt, Wr T** Water Point, Water Tap
MS Mile Stone **W** Well
NTL Normal Tidal Limit **Wd Pp** Wind Pump

Large-Scale National Grid Data 1:2,500 and 1:1,250

Cliff **Slopes** **Top**
Rock **Rock (scattered)**
Boulders **Boulders (scattered)**
Positioned Boulder **Scree**
Non-Coniferous Tree (surveyed) **Coniferous Tree (surveyed)**
Non-Coniferous Trees (not surveyed) **Coniferous Trees (not surveyed)**
Orchard Tree **Scrub** **Bracken**
Coppice, Osier **Reeds** **Marsh, Saltings**
Rough Grassland **Heath** **Culvert**
Direction of water flow **Triangulation Station** **Antiquity (site of)**
Electricity Transmission Line **Electricity Pylon**
B.M. 231.60m Bench Mark **Buildings with Building Seed**
Roofed Building **Glazed Roof Building**
Civil parish/community boundary
District boundary
County boundary
Boundary post/stone
Boundary mereing symbol (note: these always appear in opposed pairs or groups of three)
Bks Barracks **P** Pillar, Pole or Post
Bty Battery **PO** Post Office
Cemy Cemetery **PC** Public Convenience
Chy Chimney **Pp** Pump
Cis Cistern **Ppg Sta** Pumping Station
Dismtd Rly Dismantled Railway **PW** Place of Worship
EI Gen Sta Electricity Generating Station **Sewage Ppg Sta** Sewage Pumping Station
EI P Electricity Pole, Pillar **SB, S Br** Signal Box or Bridge
EI Sub Sta Electricity Sub Station **SP, SL** Signal Post or Light
FB Filter Bed **Spr** Spring
Fn / D Fn Fountain / Drinking Ftn. **Tk** Tank or Track
Gas Gov Gas Valve Compound **Tr** Trough
GVC Gas Governor **Wd Pp** Wind Pump
GP Guide Post **Wr Pt, Wr T** Water Point, Water Tap
MH Manhole **Wks** Works (building or area)
MP, MS Mile Post or Mile Stone **W** Well



Historical Mapping & Photography included:

Mapping Type	Scale	Date	Pg
Lincolnshire	1:2,500	1886	2
Lincolnshire	1:2,500	1907	3
Ordnance Survey Plan	1:2,500	1967	4
Additional SIMs	1:2,500	1967	5
Large-Scale National Grid Data	1:2,500	1994	6
Large-Scale National Grid Data	1:2,500	1995	7
Historical Aerial Photography	1:2,500	1999	8

Historical Map - Segment A6

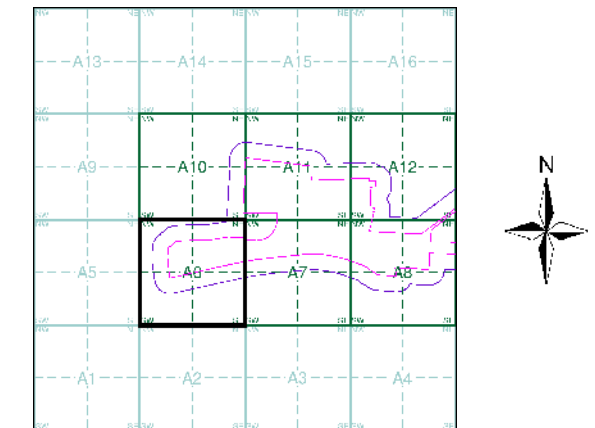

Order Details

Order Number: 242986885_1_1
 Customer Ref: 60625943
 National Grid Reference: 482060, 411790
 Slice: A
 Site Area (Ha): 68.12
 Search Buffer (m): 100

Site Details

Keaddy



Tel: 0844 844 9952
 Fax: 0844 844 9951
 Web: www.envirocheck.co.uk



Lincolnshire

Published 1886

Source map scale - 1:2,500

The historical maps shown were reproduced from maps predominantly held at the scale adopted for England, Wales and Scotland in the 1840's. In 1854 the 1:2,500 scale was adopted for mapping urban areas and by 1896 it covered the whole of what were considered to be the cultivated parts of Great Britain. The published date given below is often some years later than the surveyed date. Before 1938, all OS maps were based on the Cassini Projection, with independent surveys of a single county or group of counties, giving rise to significant inaccuracies in outlying areas.

Map Name(s) and Date(s)

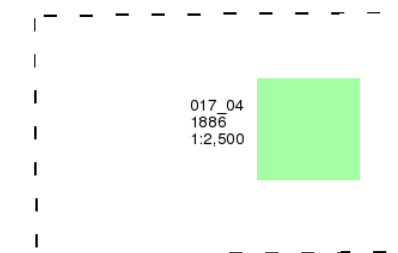

Historical Map - Segment A6

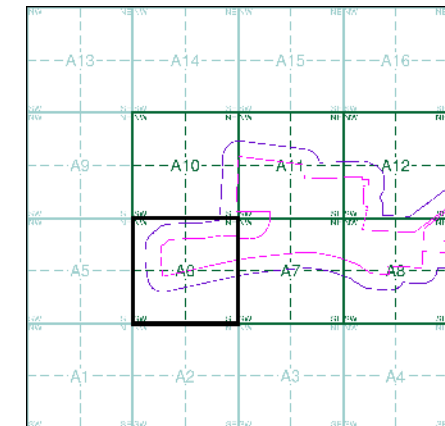

Order Details

Order Number: 242986885_1_1
Customer Ref: 60625943
National Grid Reference: 482060, 411790
Slice: A
Site Area (Ha): 68.12
Search Buffer (m): 100

Site Details

Keadby



Tel: 0844 844 9952
Fax: 0844 844 9951
Web: www.envirocheck.co.uk

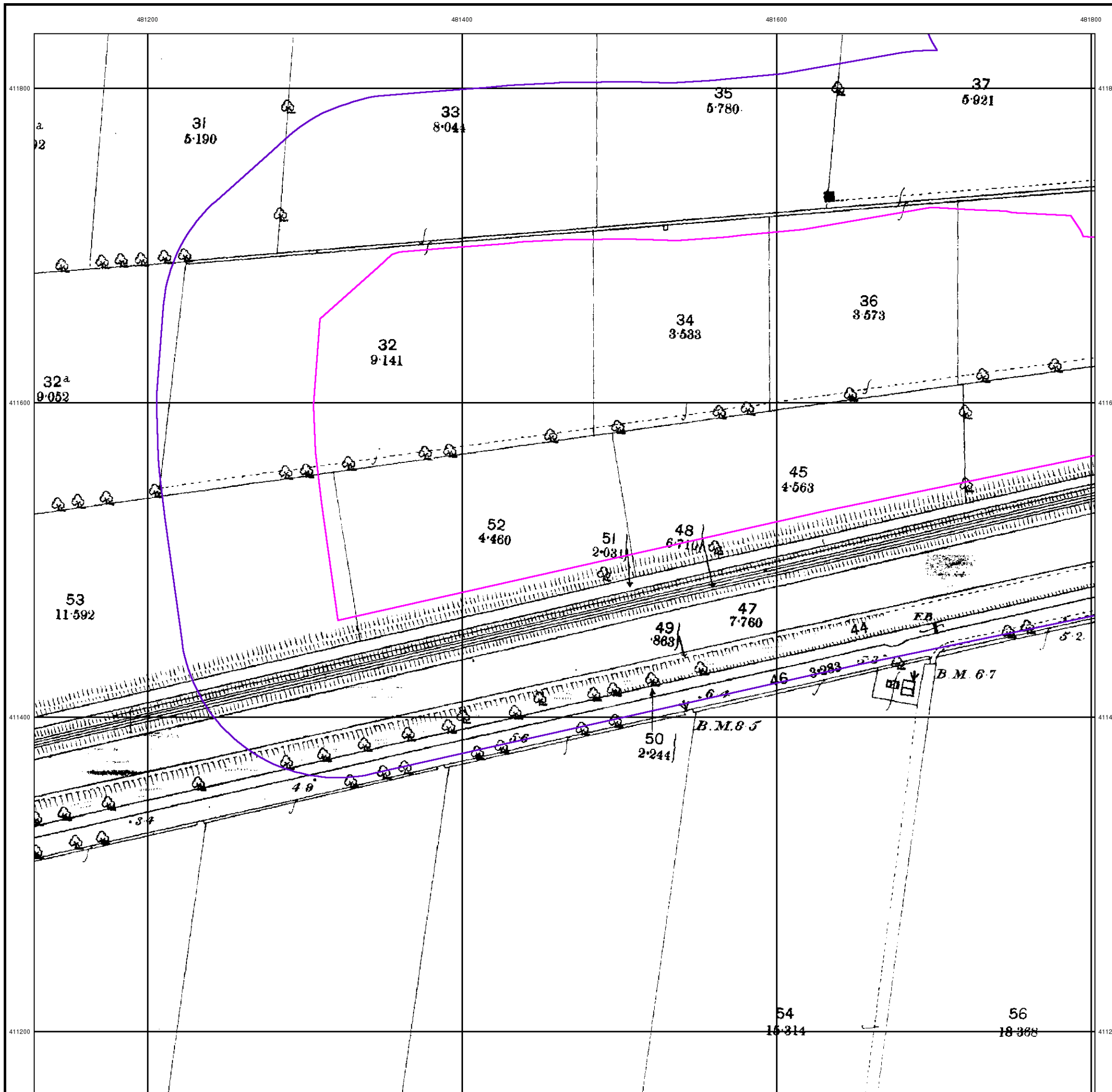



Lincolnshire

Published 1907

Source map scale - 1:2,500

The historical maps shown were reproduced from maps predominantly held at the scale adopted for England, Wales and Scotland in the 1840's. In 1854 the 1:2,500 scale was adopted for mapping urban areas and by 1896 it covered the whole of what were considered to be the cultivated parts of Great Britain. The published date given below is often some years later than the surveyed date. Before 1938, all OS maps were based on the Cassini Projection, with independent surveys of a single county or group of counties, giving rise to significant inaccuracies in outlying areas.

Map Name(s) and Date(s)

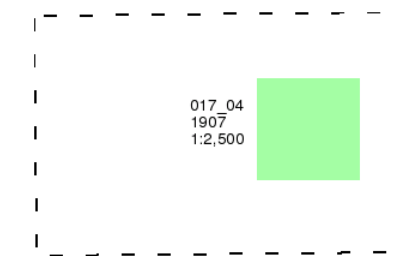

Historical Map - Segment A6

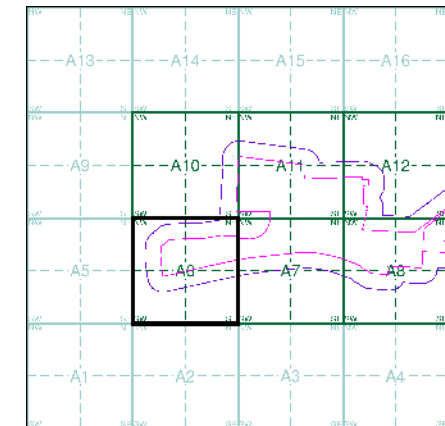

Order Details

Order Number: 242986885_1_1
Customer Ref: 60625943
National Grid Reference: 482060, 411790
Slice: A
Site Area (Ha): 68.12
Search Buffer (m): 100

Site Details

Keadby



Tel: 0844 844 9952
Fax: 0844 844 9951
Web: www.envirocheck.co.uk

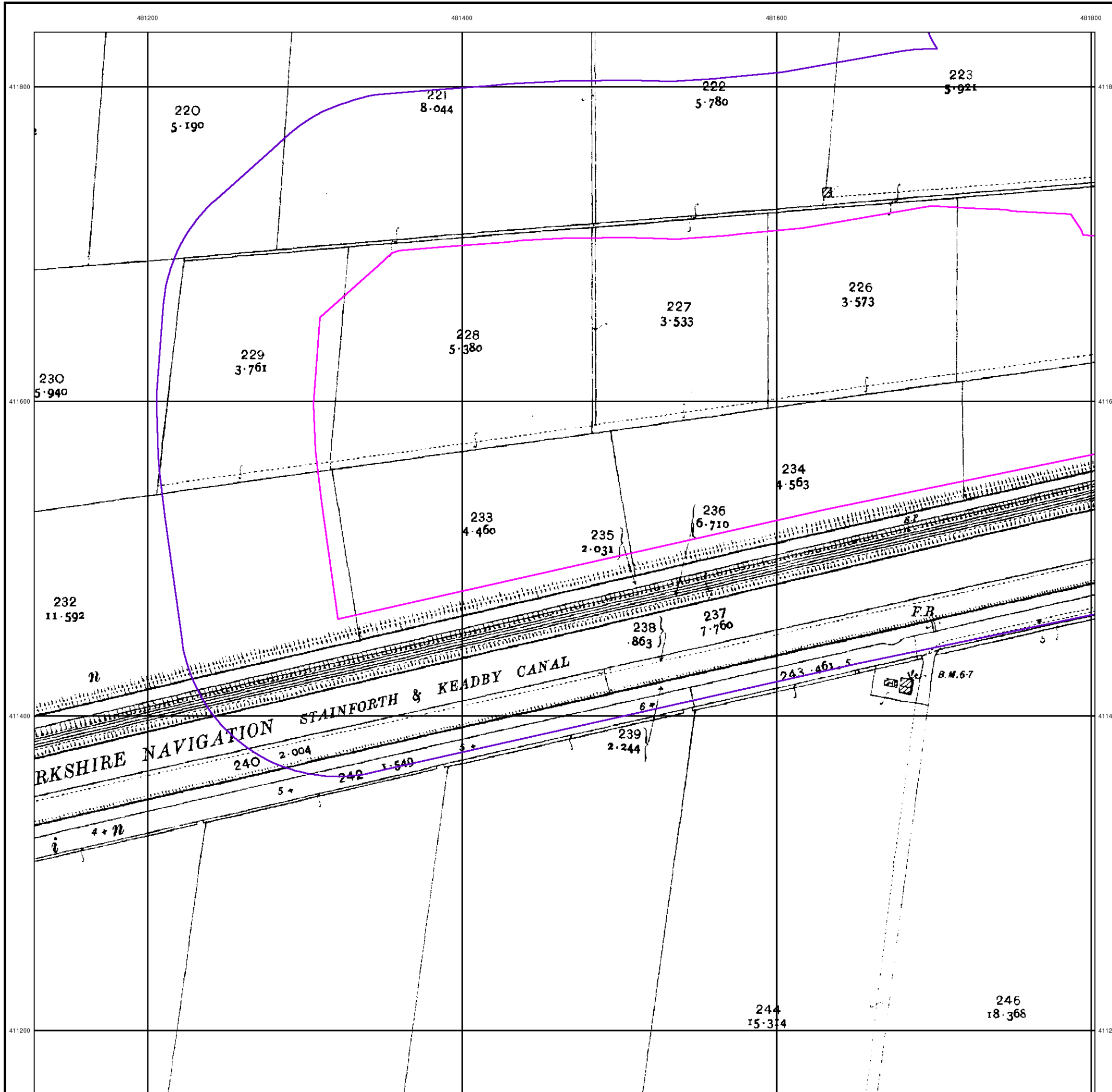



Ordnance Survey Plan

Published 1967

Source map scale - 1:2,500

The historical maps shown were reproduced from maps predominantly held at the scale adopted for England, Wales and Scotland in the 1840's. In 1854 the 1:2,500 scale was adopted for mapping urban areas and by 1896 it covered the whole of what were considered to be the cultivated parts of Great Britain. The published date given below is often some years later than the surveyed date. Before 1938, all OS maps were based on the Cassini Projection, with independent surveys of a single county or group of counties, giving rise to significant inaccuracies in outlying areas.

Map Name(s) and Date(s)

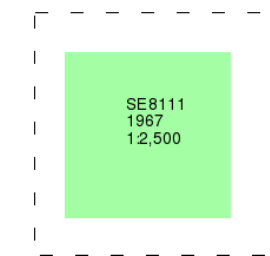

Historical Map - Segment A6

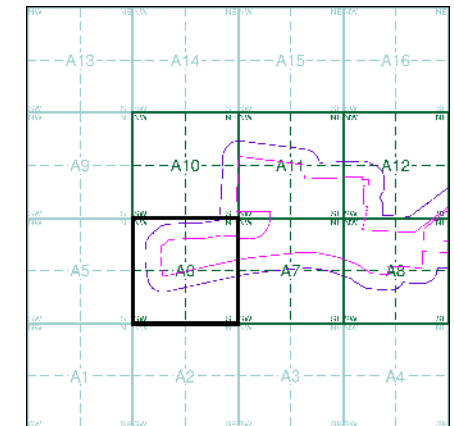

Order Details

Order Number:	242986885_1_1
Customer Ref:	60625943
National Grid Reference:	482060, 411790
Slice:	A
Site Area (Ha):	68.12
Search Buffer (m):	100

Site Details

Keadby



Tel:	0844 844 9952
Fax:	0844 844 9951
Web:	www.envirocheck.co.uk

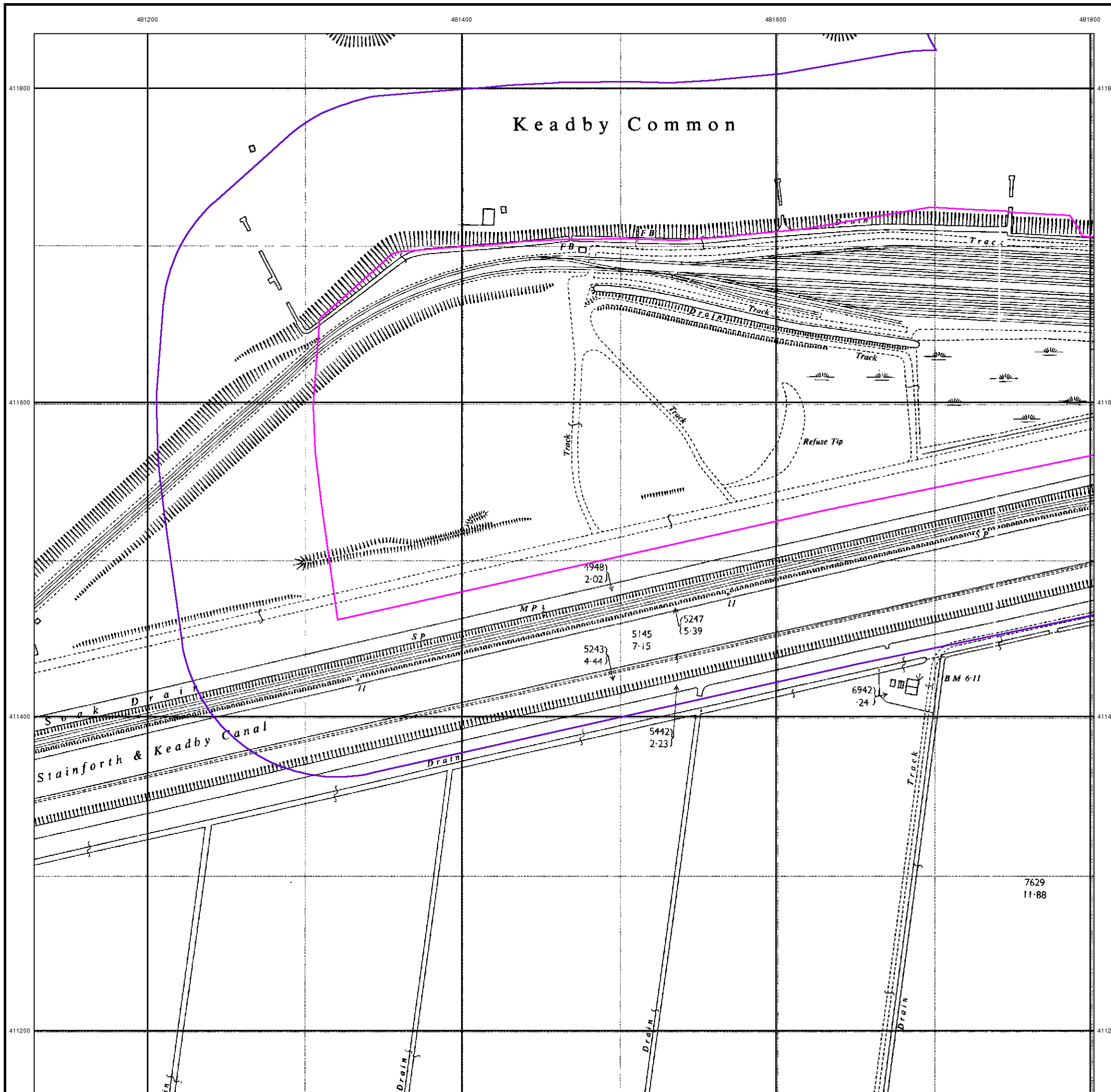



Large-Scale National Grid Data

Published 1994

Source map scale - 1:2,500

'Large Scale National Grid Data' superseded SIM cards (Ordnance Survey's 'Survey of Information on Microfilm') in 1992, and continued to be produced until 1999. These maps were the fore-runners of digital mapping and so provide detailed information on houses and roads, but tend to show less topographic features such as vegetation. These maps were produced at both 1:2,500 and 1:1,250 scales.

Map Name(s) and Date(s)

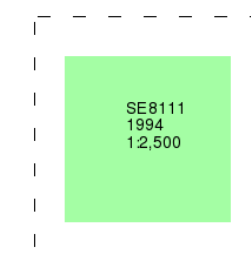

Historical Map - Segment A6

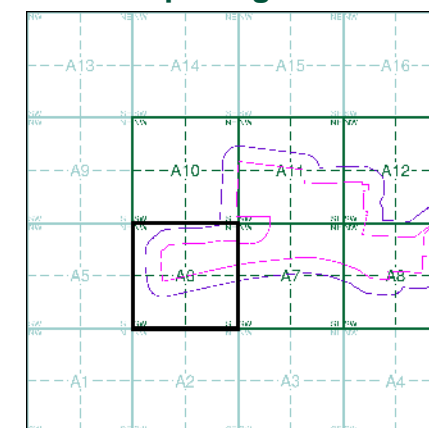

Order Details

Order Number:	242986885_1_1
Customer Ref:	60625943
National Grid Reference:	482060, 411790
Slice:	A
Site Area (Ha):	68.12
Search Buffer (m):	100

Site Details

Keadby



Tel:	0844 844 9952
Fax:	0844 844 9951
Web:	www.envirocheck.co.uk

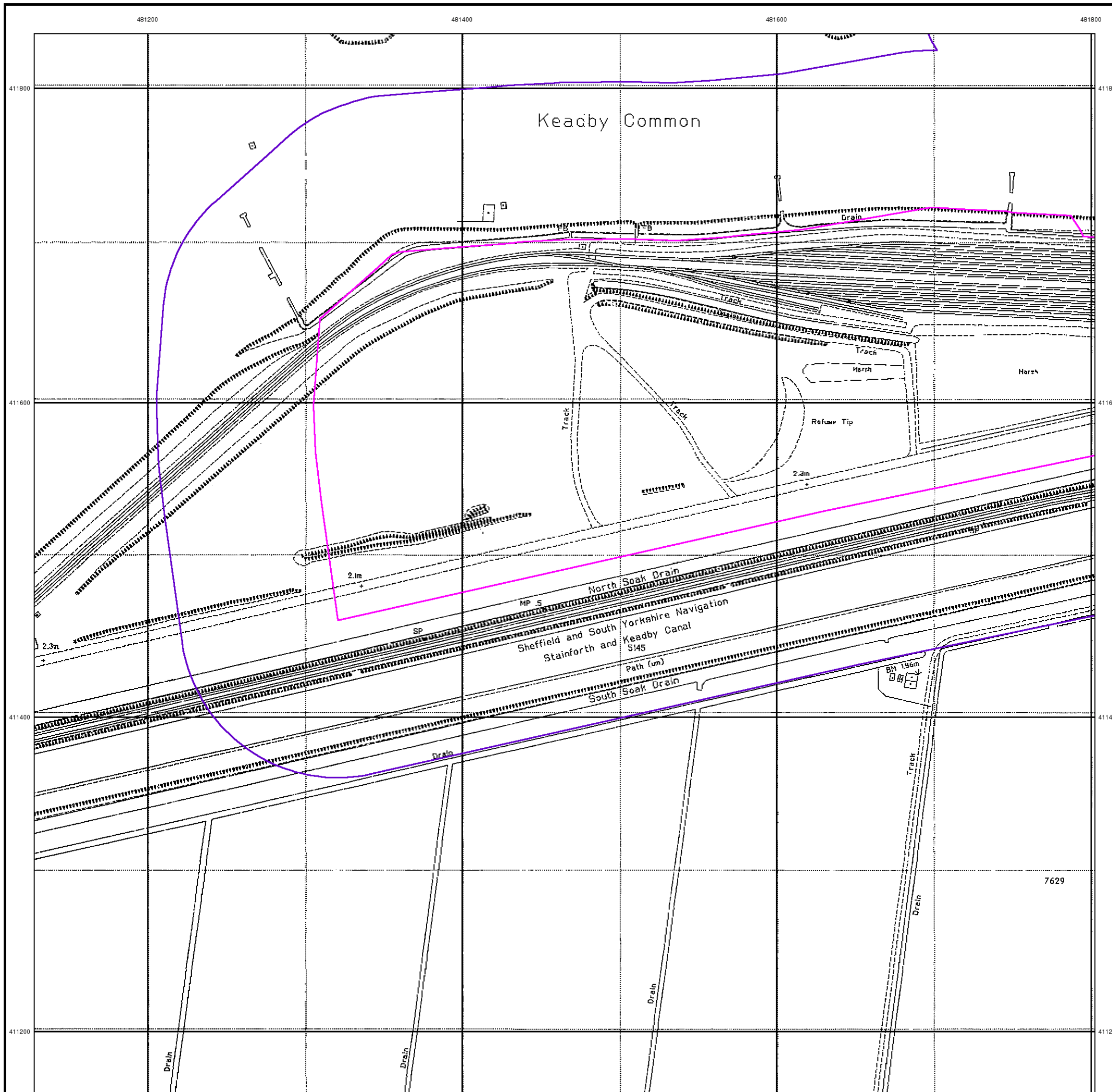



Large-Scale National Grid Data

Published 1995

Source map scale - 1:2,500

'Large Scale National Grid Data' superseded SIM cards (Ordnance Survey's 'Survey of Information on Microfilm') in 1992, and continued to be produced until 1999. These maps were the fore-runners of digital mapping and so provide detailed information on houses and roads, but tend to show less topographic features such as vegetation. These maps were produced at both 1:2,500 and 1:1,250 scales.

Map Name(s) and Date(s)

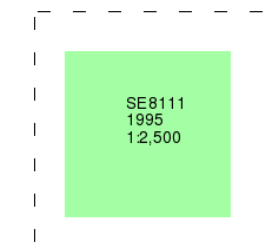

Historical Map - Segment A6

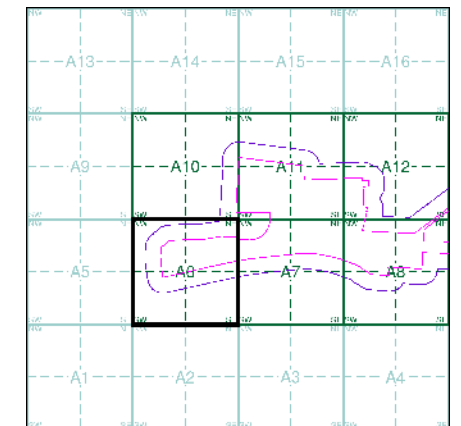

Order Details

Order Number:	242986885_1_1
Customer Ref:	60625943
National Grid Reference:	482060, 411790
Slice:	A
Site Area (Ha):	68.12
Search Buffer (m):	100

Site Details

Keadby



Tel:	0844 844 9952
Fax:	0844 844 9951
Web:	www.envirocheck.co.uk

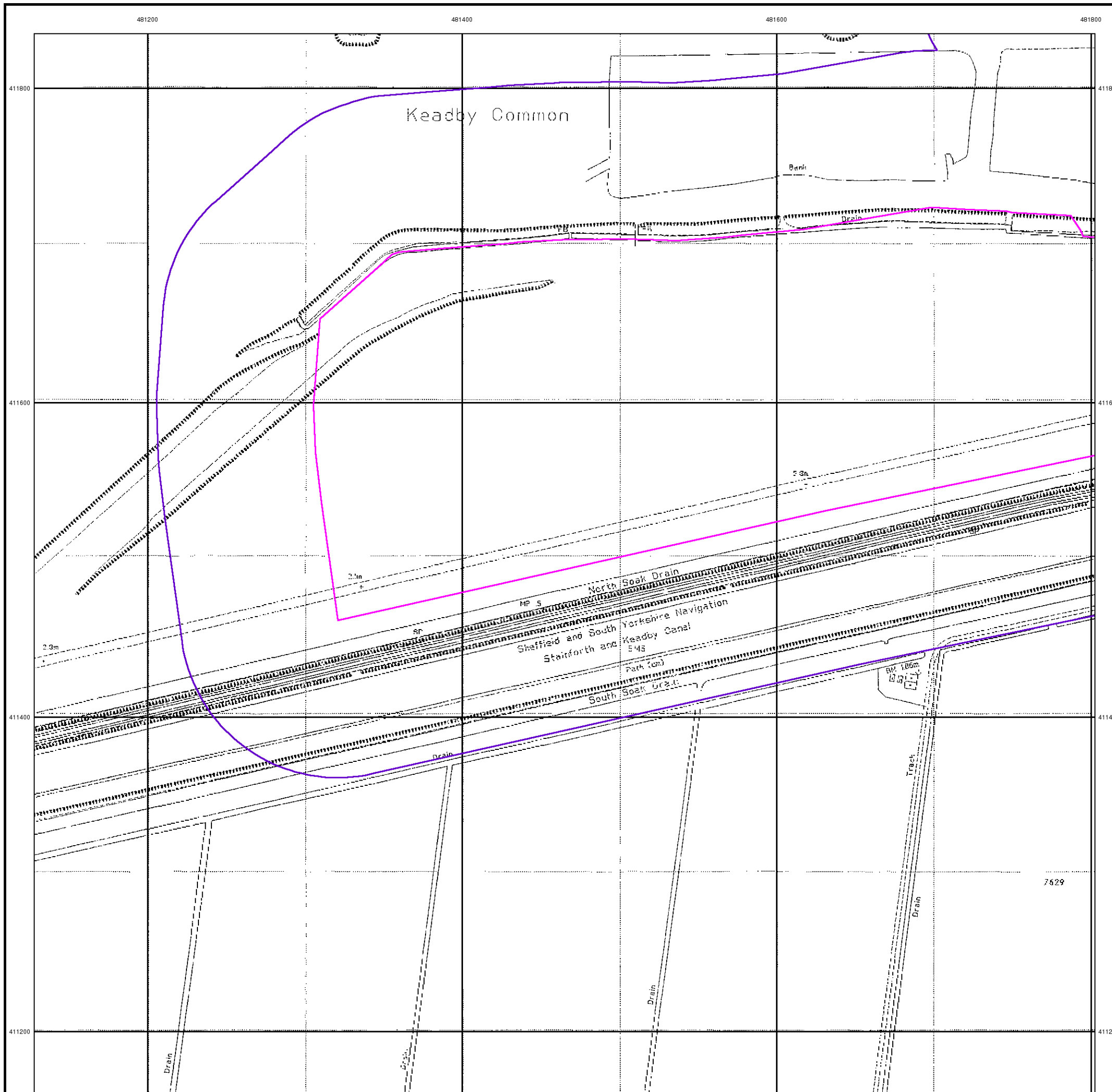



Historical Aerial Photography

Published 1999

This aerial photography was produced by Getmapping, these vertical aerial photographs provide a seamless, full colour survey of the whole of Great Britain

Historical Aerial Photography - Segment A6

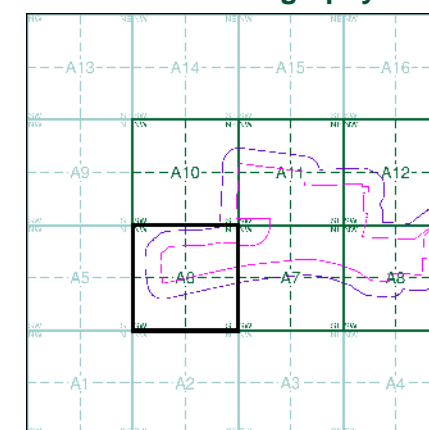

Order Details

Order Number: 242986885_1_1
Customer Ref: 60625943
National Grid Reference: 482060, 411790
Slice: A
Site Area (Ha): 68.12
Search Buffer (m): 100

Site Details

Keadby



Tel: 0844 844 9952
Fax: 0844 844 9951
Web: www.envirocheck.co.uk

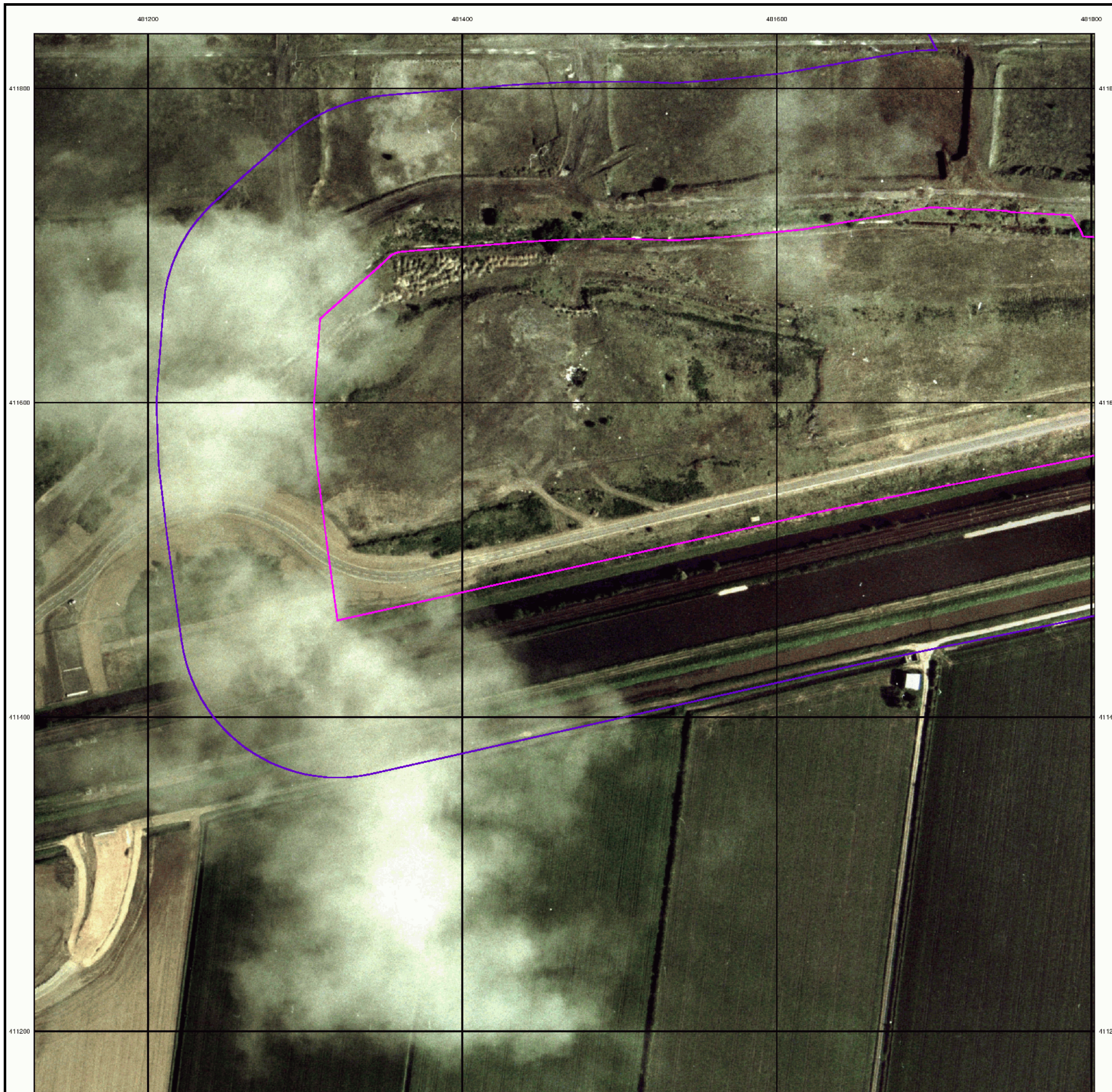

Historical Mapping Legends

Ordnance Survey County Series and Ordnance Survey Plan 1:2,500

Quarry **Gravel Pit** **Sand Pit**
Clay Pit **Shingle** **Refuse Heap**
Sloping Masonry **Flat Rock**
Marsh **Reeds** **Osiers**
Rough Pasture **Furze** **Wood**
Mixed Wood **Brushwood** **Orchard**
Fir **Ford** **Stepping Stones**
Ferry **Waterfall** **Lock**
Trig. Station **Altitude at Trig. Station**
B.M. 325.9 **Bench Mark** **Surface Level**
Arrow denotes flow of water **Antiquities (site of)**
Cutting **Embankment**
Railway crossing Road **Level Crossing** **Road crossing Railway**
Railway crossing River or Canal **Road over single stream** **Road over River or Canal**
County Boundary (Geographical)
County & Civil Parish Boundary
Administrative County & Civil Parish Boundary
County Borough Boundary (England)
County Burgh Boundary (Scotland)
Co. Boro. Bdy.
Co. Burgh Bdy.
BP BS Boundary Post or Stone **P.C.B** Police Call Box
B.R. Bridle Road **P** Pump
E.P Electricity Pylon **S.P** Signal Post
F.B. Foot Bridge **SL** Sluice
F.P. Foot Path **Sp.** Spring
G.P Guide Post or Board **T.C.B** Telephone Call Box
M.S Mile Stone **Tr.** Trough
M.P M.R Mooring Post or Ring **W** Well

Ordnance Survey Plan, Additional SIMs and Supply of Unpublished Survey Information 1:2,500 and 1:1,250

Inactive Quarry, Chalk Pit or Clay Pit **Active Quarry, Chalk Pit or Clay Pit**
Rock **Boulders**
Cliff **Slopes** **Top**
Roofed Building **Glazed Roof Building**
Sloping Masonry **Archway**
Non-Coniferous Tree (surveyed) **Coniferous Tree (surveyed)**
Non-Coniferous Trees (not surveyed) **Coniferous Trees (not surveyed)**
Orchard Tree **Scrub** **Bracken**
Coppice, Osier **Reeds** **Marsh, Saltings**
Rough Grassland **Heath** **Culvert**
Direction of water flow **Bench Mark** **Antiquity (site of)**
Cave Entrance **Triangulation Station** **Electricity Pylon**
Electricity Transmission Line
County Boundary (Geographical)
County & Civil Parish Boundary
Civil Parish Boundary
Admin. County or County Bor. Boundary
London Borough Boundary
Symbol marking point where boundary mereing changes
BH Beer House **P** Pillar, Pole or Post
BP, BS Boundary Post or Stone **PO** Post Office
Cn, C Capstan, Crane **PC** Public Convenience
Chy Chimney **PH** Public House
D Fn Drinking Fountain **Pp** Pump
EI P Electricity Pillar or Post **SB, S Br** Signal Box or Bridge
FAP Fire Alarm Pillar **SP, SL** Signal Post or Light
FB Foot Bridge **Spr** Spring
GP Guide Post **Tk** Tank or Track
H Hydrant or Hydraulic **TCB** Telephone Call Box
LC Level Crossing **TCP** Telephone Call Post
MH Manhole **Tr** Trough
MP Mile Post or Mooring Post **Wr Pt, Wr T** Water Point, Water Tap
MS Mile Stone **W** Well
NTL Normal Tidal Limit **Wd Pp** Wind Pump

Large-Scale National Grid Data 1:2,500 and 1:1,250

Cliff **Slopes** **Top**
Rock **Rock (scattered)**
Boulders **Boulders (scattered)**
Positioned Boulder **Scree**
Non-Coniferous Tree (surveyed) **Coniferous Tree (surveyed)**
Non-Coniferous Trees (not surveyed) **Coniferous Trees (not surveyed)**
Orchard Tree **Scrub** **Bracken**
Coppice, Osier **Reeds** **Marsh, Saltings**
Rough Grassland **Heath** **Culvert**
Direction of water flow **Triangulation Station** **Antiquity (site of)**
Electricity Transmission Line **Electricity Pylon**
B.M. 231.60m Bench Mark **Buildings with Building Seed**
Roofed Building **Glazed Roof Building**
Civil parish/community boundary
District boundary
County boundary
Boundary post/stone
Boundary mereing symbol (note: these always appear in opposed pairs or groups of three)
Bks Barracks **P** Pillar, Pole or Post
Bty Battery **PO** Post Office
Cemy Cemetery **PC** Public Convenience
Chy Chimney **Pp** Pump
Cis Cistern **Ppg Sta** Pumping Station
Dismtd Rly Dismantled Railway **PW** Place of Worship
EI Gen Sta Electricity Generating Station **Sewage Ppg Sta** Sewage Pumping Station
EI P Electricity Pole, Pillar **SB, S Br** Signal Box or Bridge
EI Sub Sta Electricity Sub Station **SP, SL** Signal Post or Light
FB Filter Bed **Spr** Spring
Fn / D Fn Fountain / Drinking Ftn. **Tk** Tank or Track
Gas Gov Gas Valve Compound **Tr** Trough
GVC Gas Governor **Wd Pp** Wind Pump
GP Guide Post **Wr Pt, Wr T** Water Point, Water Tap
MH Manhole **Wks** Works (building or area)
MP, MS Mile Post or Mile Stone **W** Well



Historical Mapping & Photography included:

Mapping Type	Scale	Date	Pg
Lincolnshire	1:2,500	1886 - 1887	2
Lincolnshire	1:2,500	1907	3
Ordnance Survey Plan	1:2,500	1967	4
Additional SIMs	1:2,500	1967 - 1978	5
Additional SIMs	1:2,500	1991	6
Large-Scale National Grid Data	1:2,500	1994	7
Large-Scale National Grid Data	1:2,500	1995	8
Large-Scale National Grid Data	1:2,500	1995	9
Historical Aerial Photography	1:2,500	1999	10

Historical Map - Segment A7

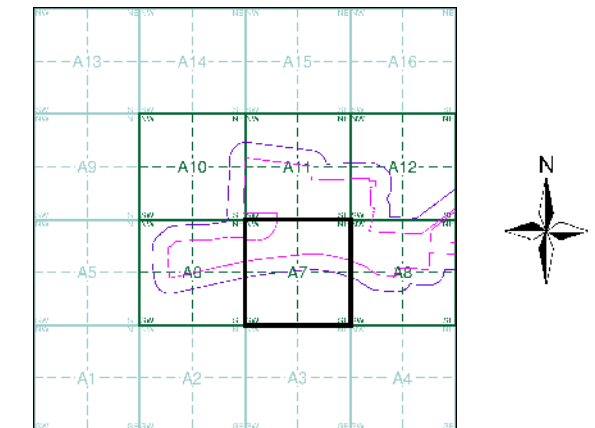

Order Details

Order Number: 242986885_1_1
 Customer Ref: 60625943
 National Grid Reference: 482060, 411790
 Slice: A
 Site Area (Ha): 68.12
 Search Buffer (m): 100

Site Details

Keaddy



Tel: 0844 844 9952
 Fax: 0844 844 9951
 Web: www.envirocheck.co.uk



Lincolnshire

Published 1886 - 1887

Source map scale - 1:2,500

The historical maps shown were reproduced from maps predominantly held at the scale adopted for England, Wales and Scotland in the 1840's. In 1854 the 1:2,500 scale was adopted for mapping urban areas and by 1896 it covered the whole of what were considered to be the cultivated parts of Great Britain. The published date given below is often some years later than the surveyed date. Before 1938, all OS maps were based on the Cassini Projection, with independent surveys of a single county or group of counties, giving rise to significant inaccuracies in outlying areas.

Map Name(s) and Date(s)

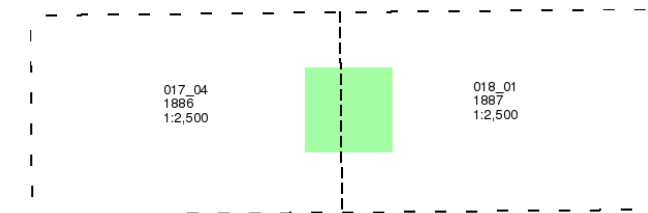

Historical Map - Segment A7

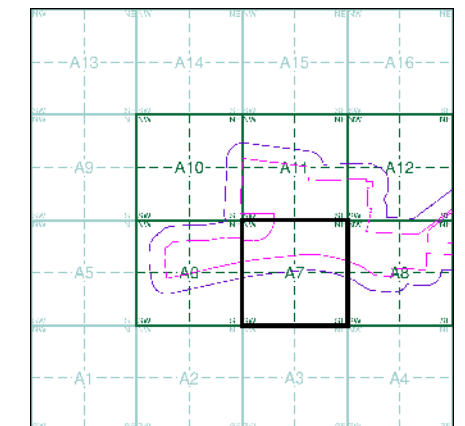

Order Details

Order Number: 242986885_1_1
Customer Ref: 60625943
National Grid Reference: 482060, 411790
Slice: A
Site Area (Ha): 68.12
Search Buffer (m): 100

Site Details

Keadby



Tel: 0844 844 9952
Fax: 0844 844 9951
Web: www.envirocheck.co.uk

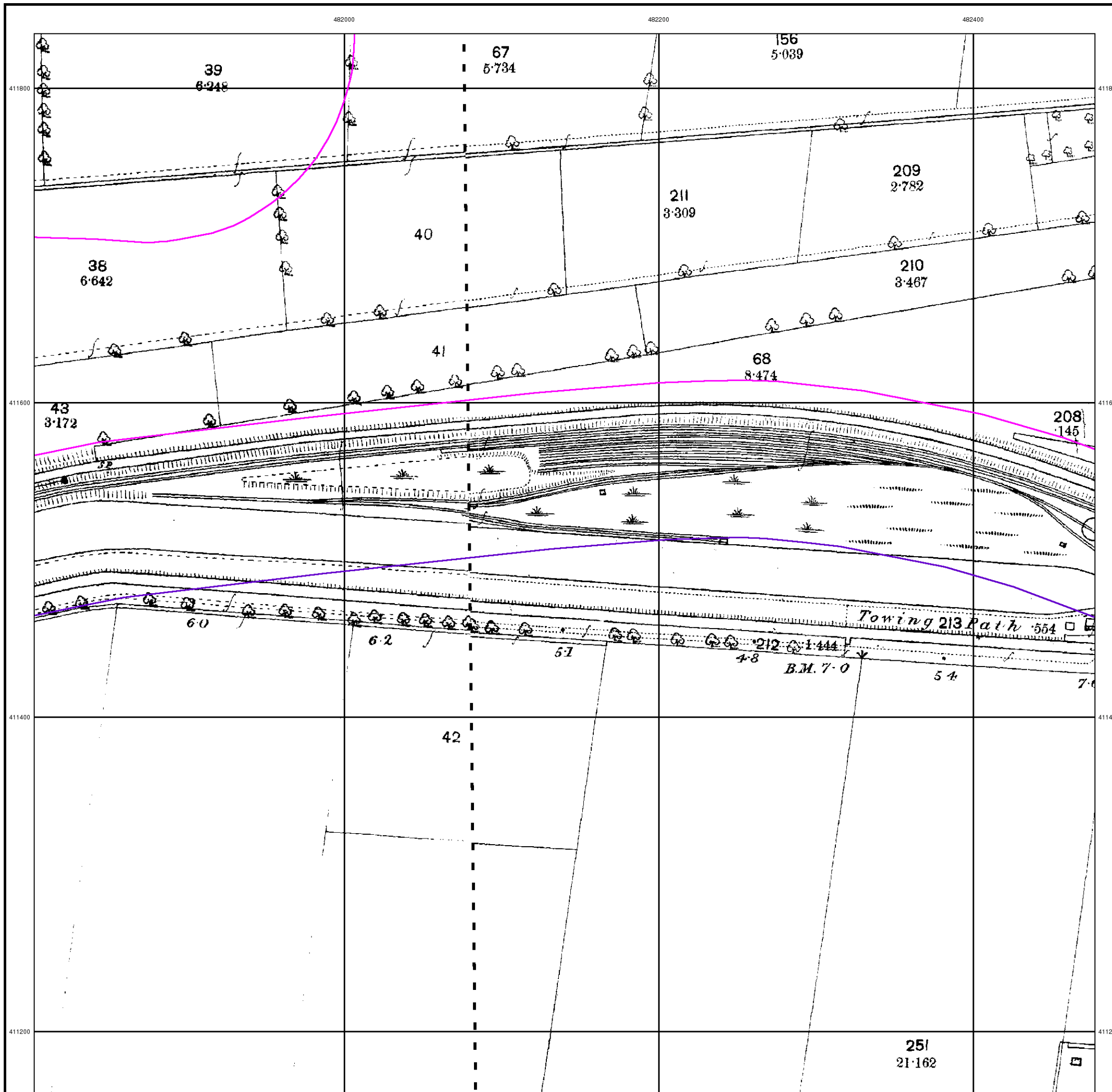



Lincolnshire

Published 1907

Source map scale - 1:2,500

The historical maps shown were reproduced from maps predominantly held at the scale adopted for England, Wales and Scotland in the 1840's. In 1854 the 1:2,500 scale was adopted for mapping urban areas and by 1896 it covered the whole of what were considered to be the cultivated parts of Great Britain. The published date given below is often some years later than the surveyed date. Before 1938, all OS maps were based on the Cassini Projection, with independent surveys of a single county or group of counties, giving rise to significant inaccuracies in outlying areas.

Map Name(s) and Date(s)

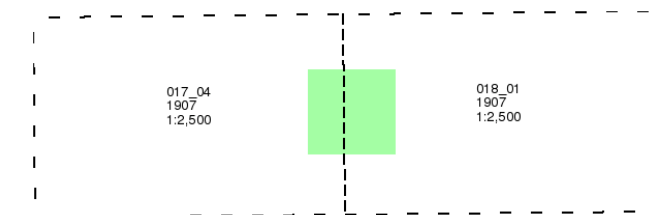

Historical Map - Segment A7

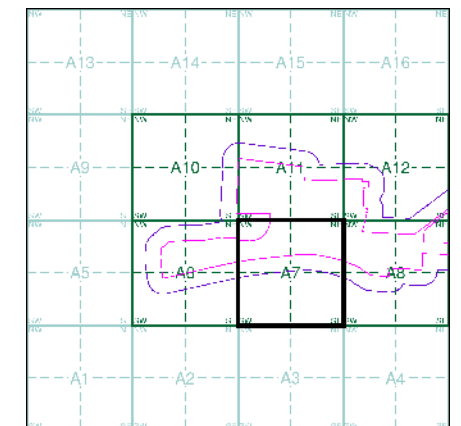

Order Details

Order Number: 242986885_1_1
Customer Ref: 60625943
National Grid Reference: 482060, 411790
Slice: A
Site Area (Ha): 68.12
Search Buffer (m): 100

Site Details

Keadby



Tel: 0844 844 9952
Fax: 0844 844 9951
Web: www.envirocheck.co.uk

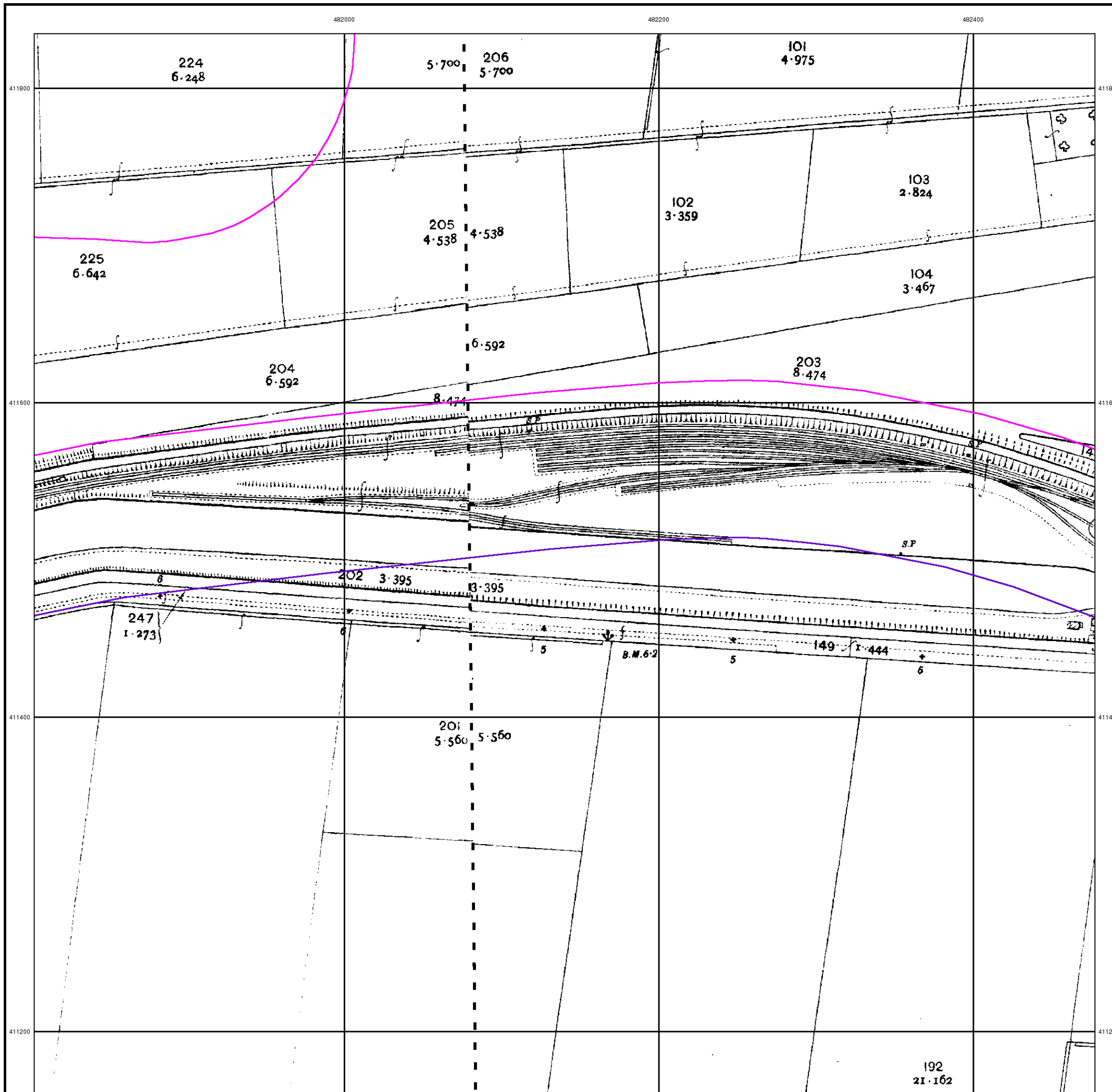



Ordnance Survey Plan

Published 1967

Source map scale - 1:2,500

The historical maps shown were reproduced from maps predominantly held at the scale adopted for England, Wales and Scotland in the 1840's. In 1854 the 1:2,500 scale was adopted for mapping urban areas and by 1896 it covered the whole of what were considered to be the cultivated parts of Great Britain. The published date given below is often some years later than the surveyed date. Before 1938, all OS maps were based on the Cassini Projection, with independent surveys of a single county or group of counties, giving rise to significant inaccuracies in outlying areas.

Map Name(s) and Date(s)

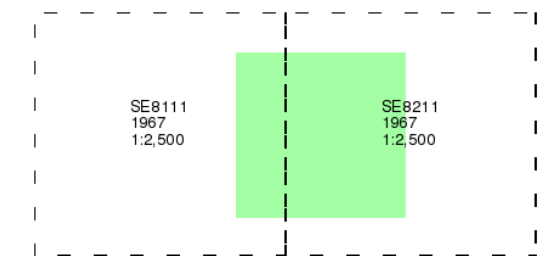

Historical Map - Segment A7

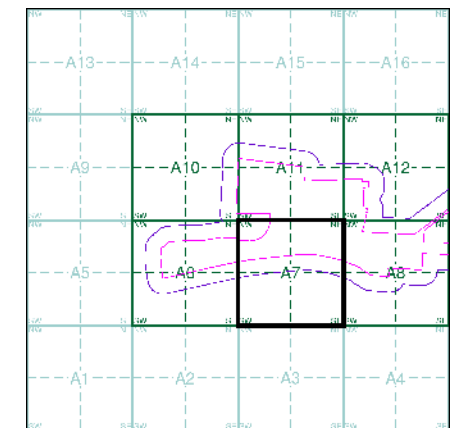

Order Details

Order Number: 242986885_1_1
Customer Ref: 60625943
National Grid Reference: 482060, 411790
Slice: A
Site Area (Ha): 68.12
Search Buffer (m): 100

Site Details

Keadby



Tel: 0844 844 9952
Fax: 0844 844 9951
Web: www.envirocheck.co.uk

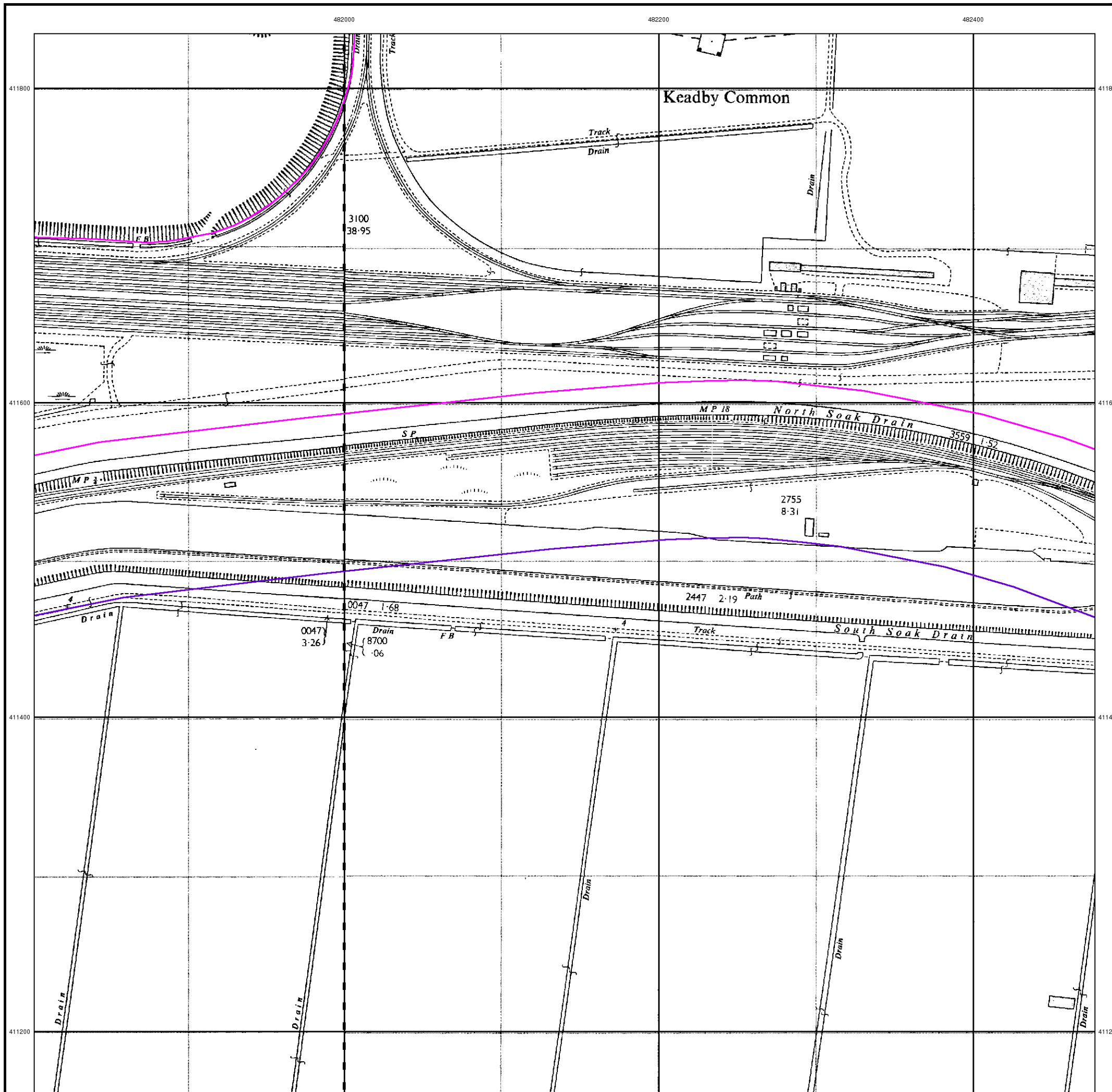



Additional SIMs

Published 1967 - 1978

Source map scale - 1:2,500

The SIM cards (Ordnance Survey's 'Survey of Information on Microfilm') are further, minor editions of mapping which were produced and published in between the main editions as an area was updated. They date from 1947 to 1994, and contain detailed information on buildings, roads and land-use. These maps were produced at both 1:2,500 and 1:1,250 scales.

Map Name(s) and Date(s)

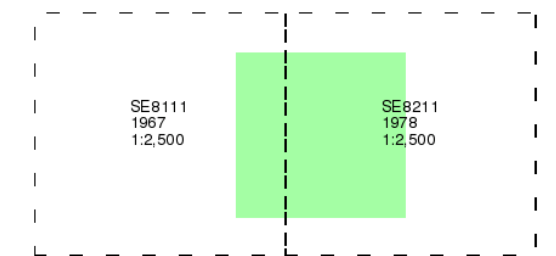

Historical Map - Segment A7

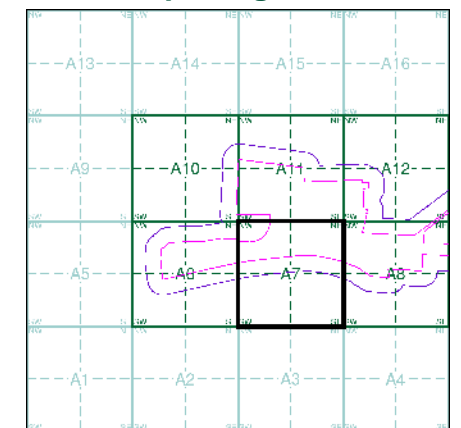

Order Details

Order Number: 242986885_1_1
 Customer Ref: 60625943
 National Grid Reference: 482060, 411790
 Slice: A
 Site Area (Ha): 68.12
 Search Buffer (m): 100

Site Details

Keadby



Tel: 0844 844 9952
 Fax: 0844 844 9951
 Web: www.envirocheck.co.uk

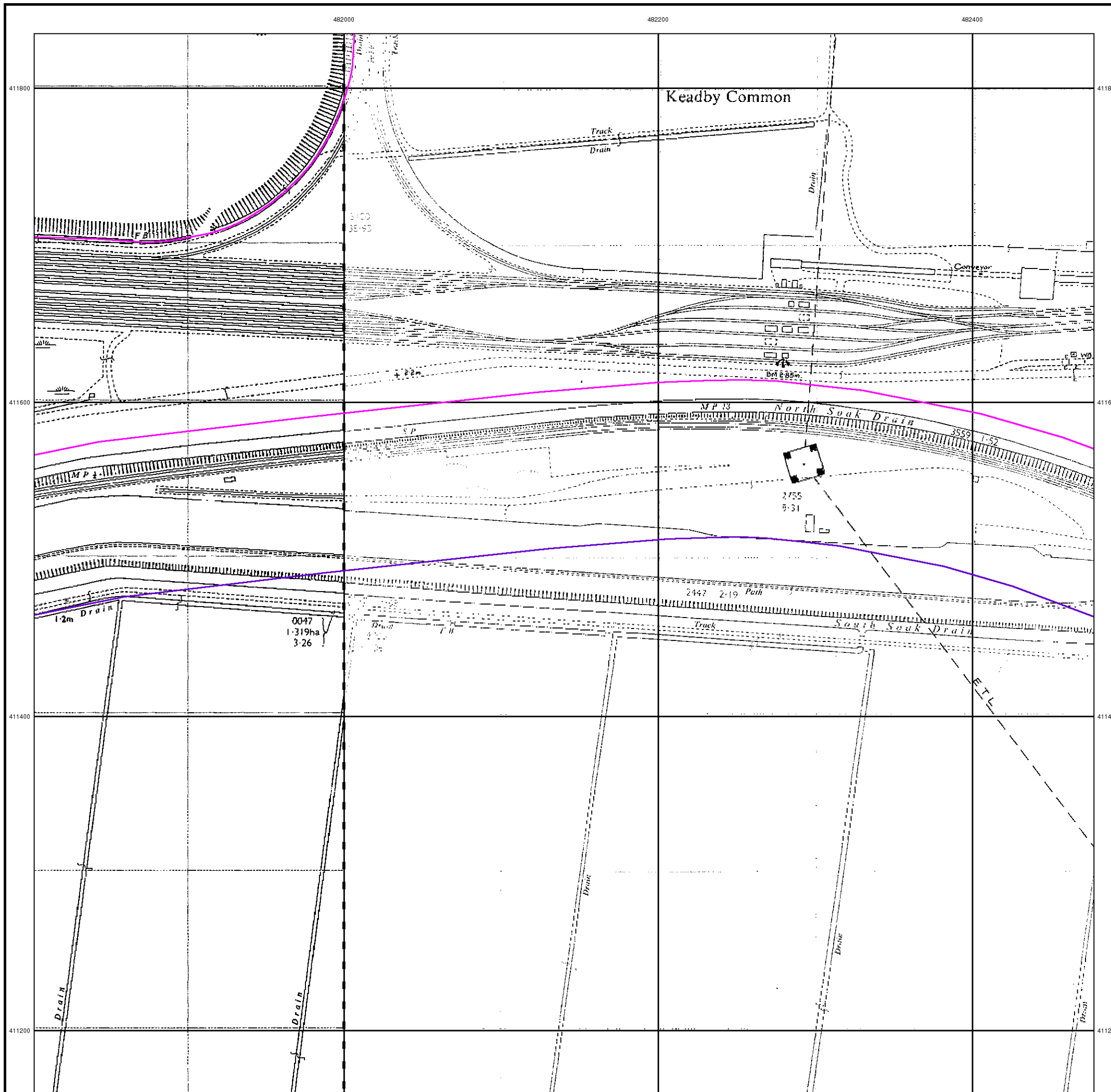



Additional SIMs

Published 1991

Source map scale - 1:2,500

The SIM cards (Ordnance Survey's 'Survey of Information on Microfilm') are further, minor editions of mapping which were produced and published in between the main editions as an area was updated. They date from 1947 to 1994, and contain detailed information on buildings, roads and land-use. These maps were produced at both 1:2,500 and 1:1,250 scales.

Map Name(s) and Date(s)

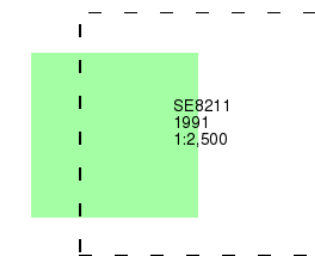

Historical Map - Segment A7

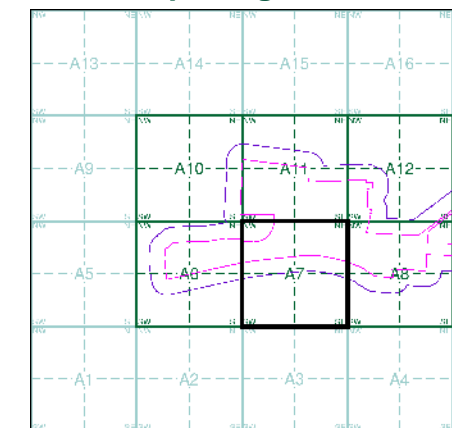

Order Details

Order Number:	242986885_1_1
Customer Ref:	60625943
National Grid Reference:	482060, 411790
Slice:	A
Site Area (Ha):	68.12
Search Buffer (m):	100

Site Details

Keadby



Tel:	0844 844 9952
Fax:	0844 844 9951
Web:	www.envirocheck.co.uk

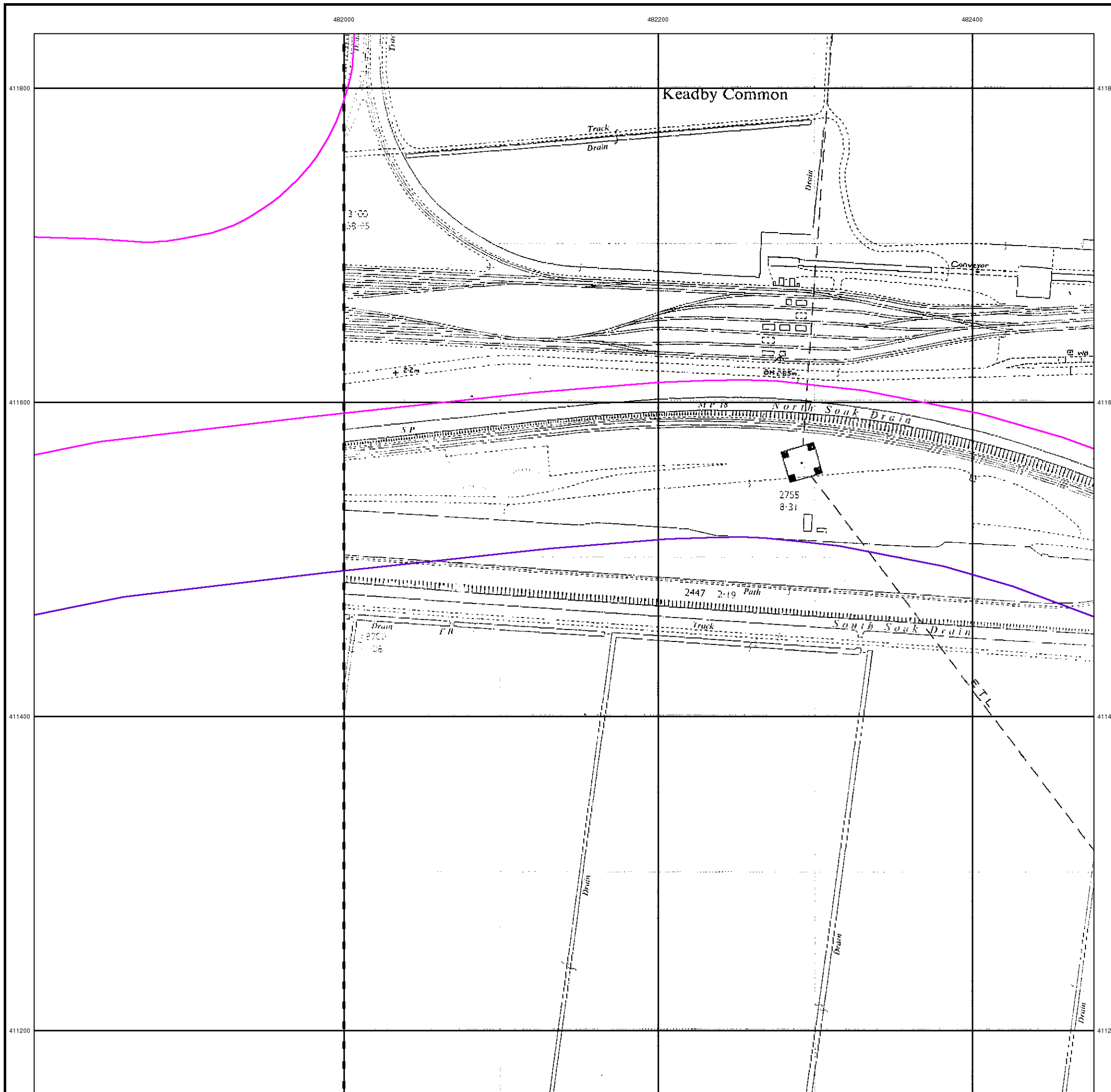



Large-Scale National Grid Data

Published 1994

Source map scale - 1:2,500

'Large Scale National Grid Data' superseded SIM cards (Ordnance Survey's 'Survey of Information on Microfilm') in 1992, and continued to be produced until 1999. These maps were the fore-runners of digital mapping and so provide detailed information on houses and roads, but tend to show less topographic features such as vegetation. These maps were produced at both 1:2,500 and 1:1,250 scales.

Map Name(s) and Date(s)

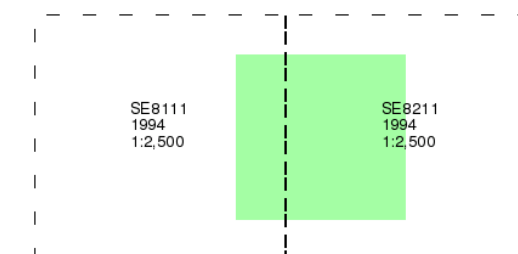

Historical Map - Segment A7

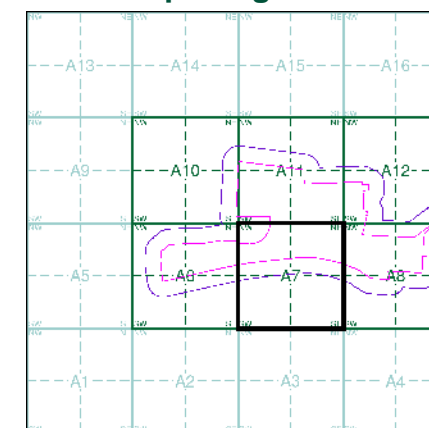

Order Details

Order Number: 242986885_1_1
 Customer Ref: 60625943
 National Grid Reference: 482060, 411790
 Slice: A
 Site Area (Ha): 68.12
 Search Buffer (m): 100

Site Details

Keadby



Tel: 0844 844 9952
 Fax: 0844 844 9951
 Web: www.envirocheck.co.uk

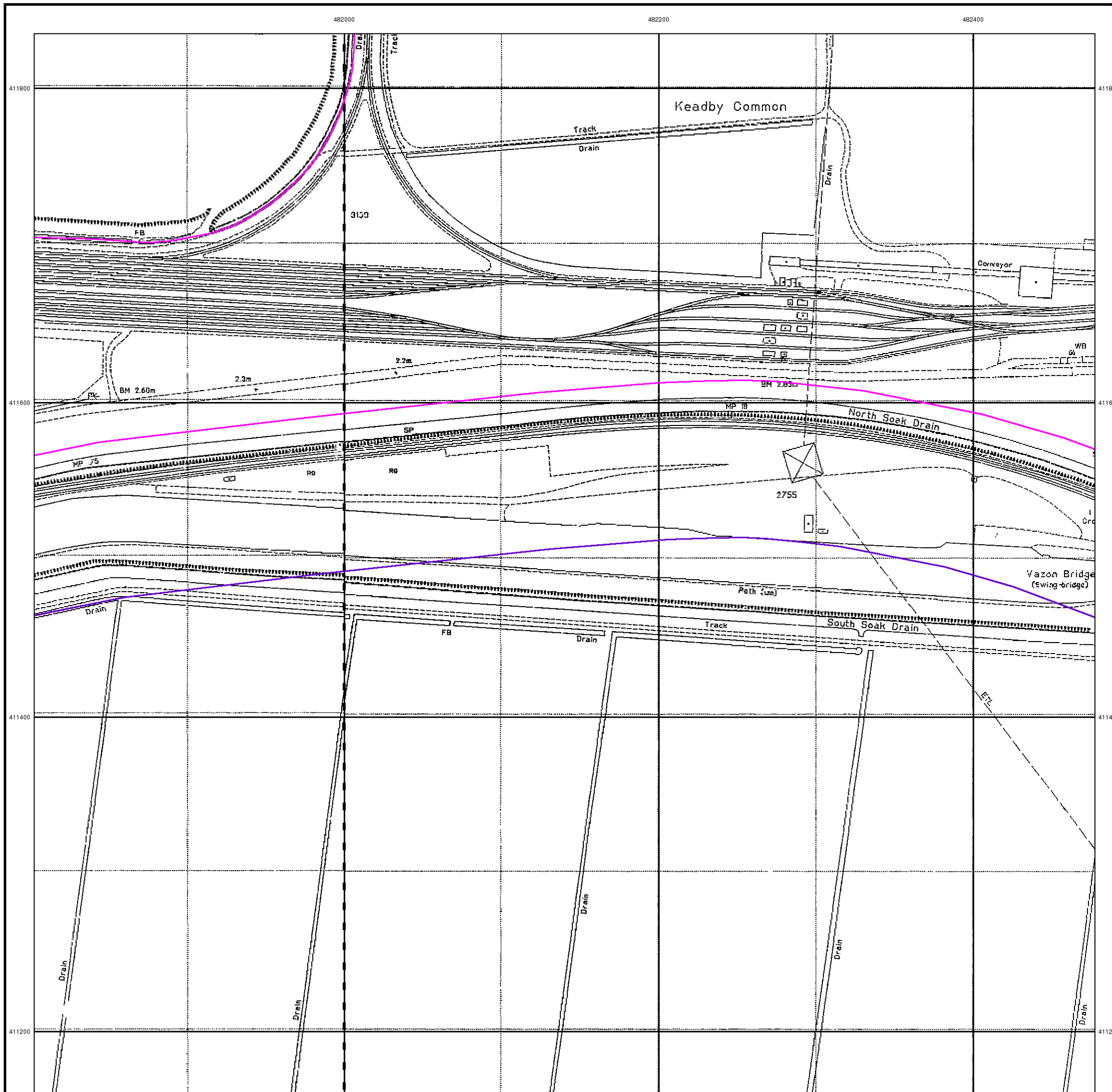



Large-Scale National Grid Data

Published 1995

Source map scale - 1:2,500

'Large Scale National Grid Data' superseded SIM cards (Ordnance Survey's 'Survey of Information on Microfilm') in 1992, and continued to be produced until 1999. These maps were the fore-runners of digital mapping and so provide detailed information on houses and roads, but tend to show less topographic features such as vegetation. These maps were produced at both 1:2,500 and 1:1,250 scales.

Map Name(s) and Date(s)

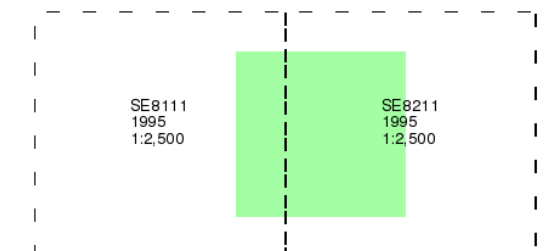

Historical Map - Segment A7

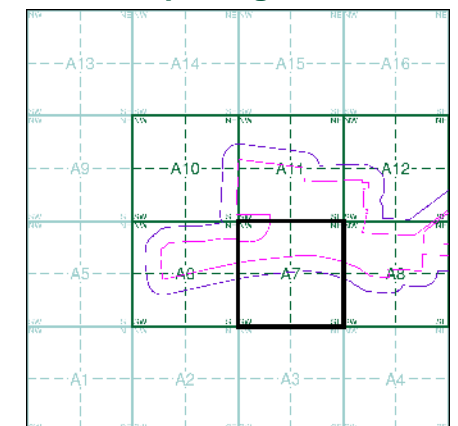

Order Details

Order Number: 242986885_1_1
Customer Ref: 60625943
National Grid Reference: 482060, 411790
Slice: A
Site Area (Ha): 68.12
Search Buffer (m): 100

Site Details

Keadby



Tel: 0844 844 9952
Fax: 0844 844 9951
Web: www.envirocheck.co.uk

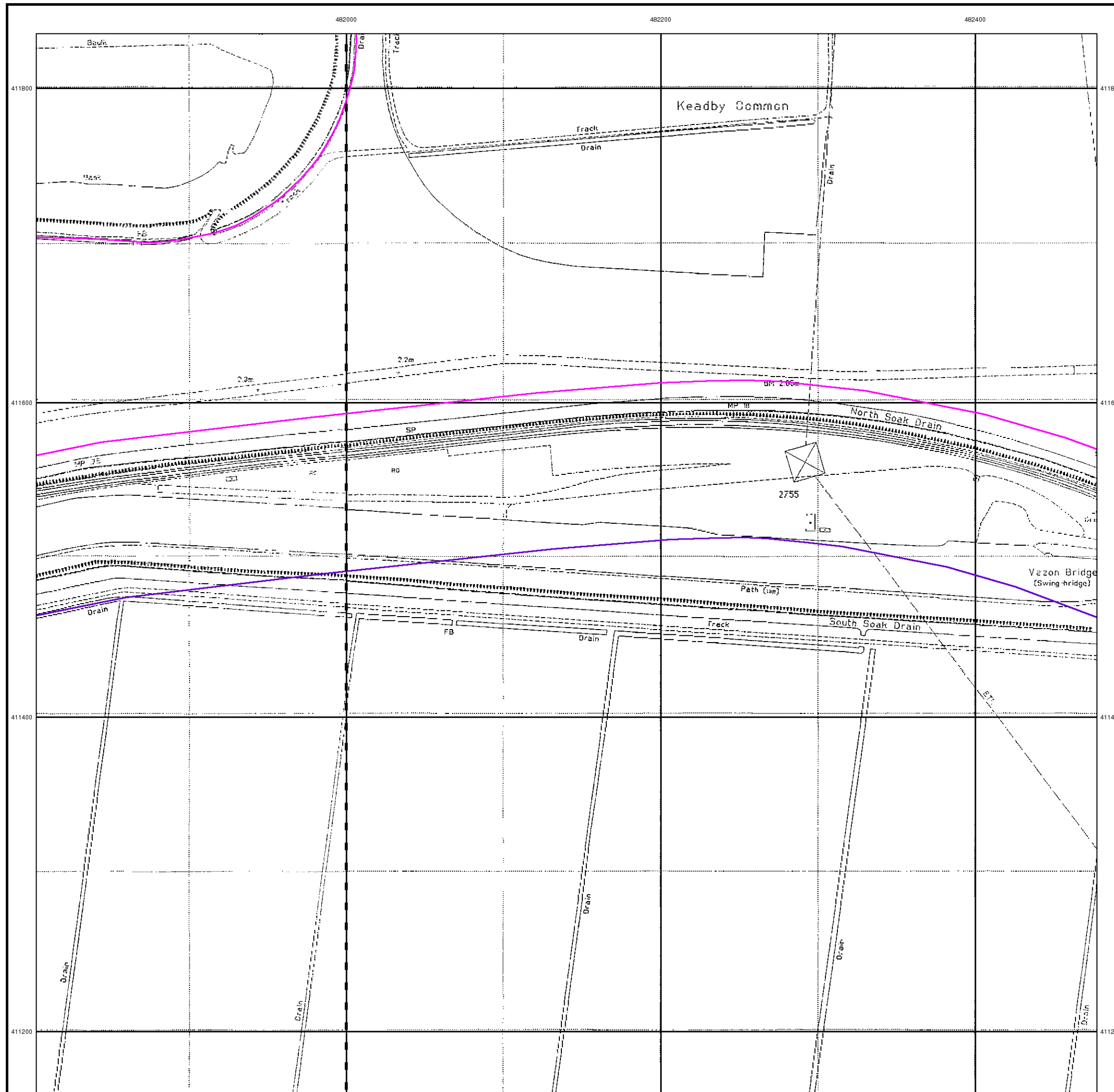



Large-Scale National Grid Data

Published 1995

Source map scale - 1:2,500

'Large Scale National Grid Data' superseded SIM cards (Ordnance Survey's 'Survey of Information on Microfilm') in 1992, and continued to be produced until 1999. These maps were the fore-runners of digital mapping and so provide detailed information on houses and roads, but tend to show less topographic features such as vegetation. These maps were produced at both 1:2,500 and 1:1,250 scales.

Map Name(s) and Date(s)

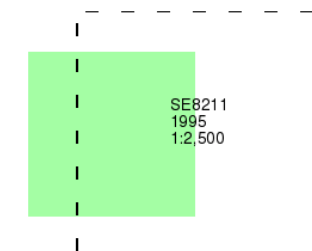

Historical Map - Segment A7

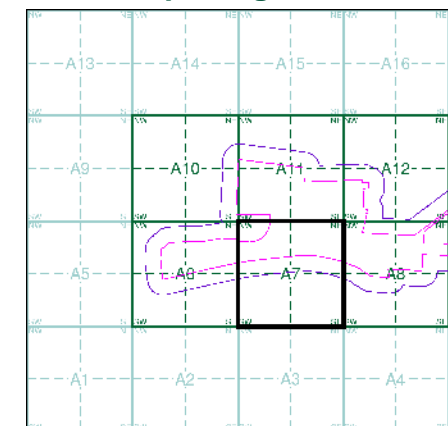

Order Details

Order Number: 242986885_1_1
Customer Ref: 60625943
National Grid Reference: 482060, 411790
Slice: A
Site Area (Ha): 68.12
Search Buffer (m): 100

Site Details

Keadby



Tel: 0844 844 9952
Fax: 0844 844 9951
Web: www.envirocheck.co.uk

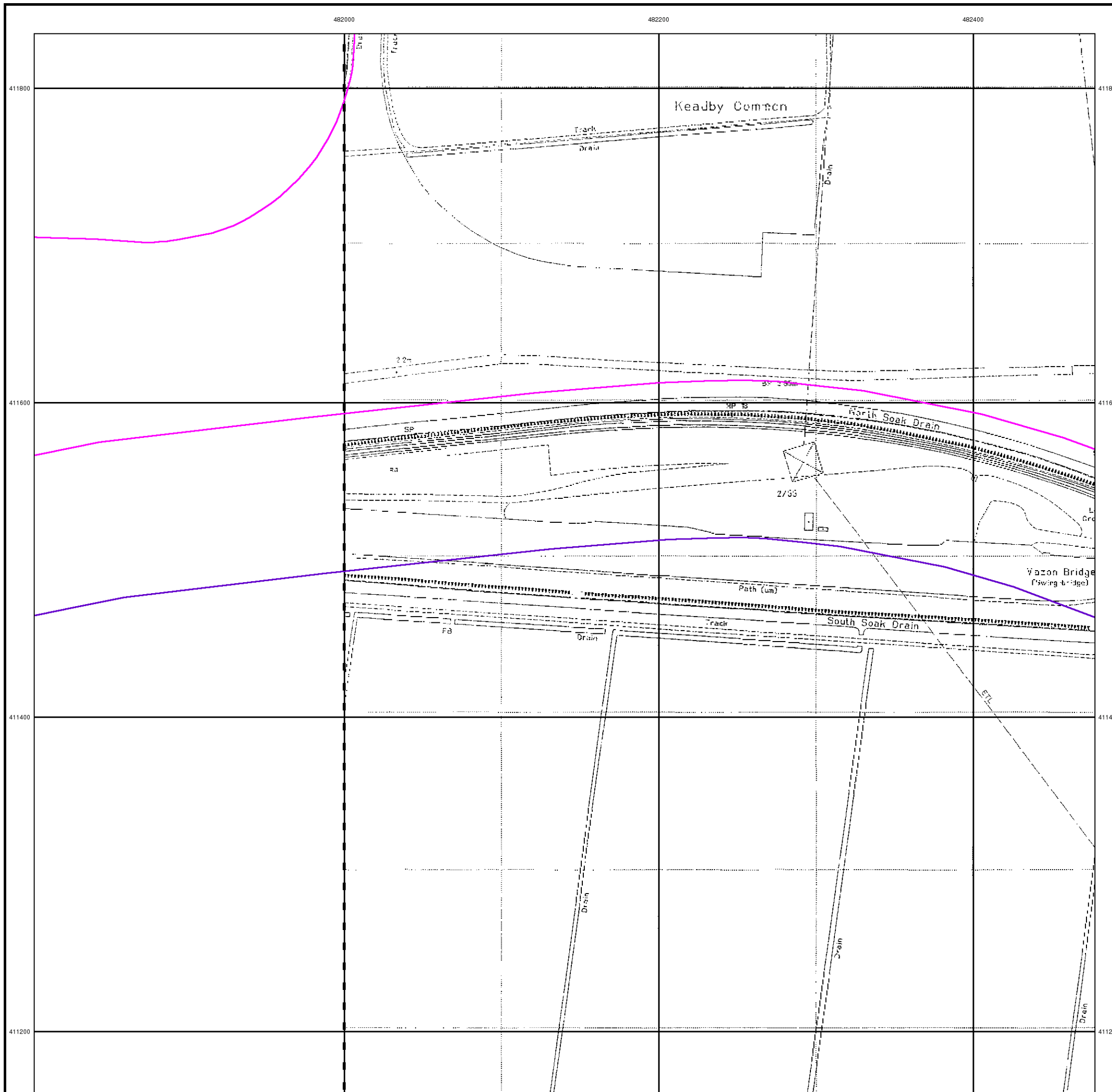



Historical Aerial Photography

Published 1999

This aerial photography was produced by Getmapping, these vertical aerial photographs provide a seamless, full colour survey of the whole of Great Britain

Historical Aerial Photography - Segment A7

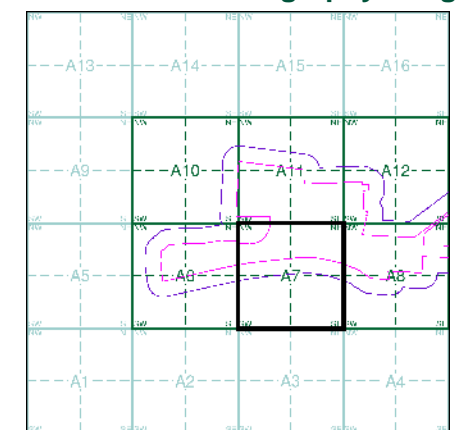

Order Details

Order Number: 242986885_1_1
Customer Ref: 60625943
National Grid Reference: 482060, 411790
Slice: A
Site Area (Ha): 68.12
Search Buffer (m): 100

Site Details

Keadby



Tel: 0844 844 9952
Fax: 0844 844 9951
Web: www.envirocheck.co.uk



Historical Mapping Legends

Ordnance Survey County Series and Ordnance Survey Plan 1:2,500

Quarry **Gravel Pit** **Sand Pit**
Clay Pit **Shingle** **Refuse Heap**
Sloping Masonry **Flat Rock**
Marsh **Reeds** **Osiers**
Rough Pasture **Furze** **Wood**
Mixed Wood **Brushwood** **Orchard**
Fir **Ford** **Stepping Stones**
Ferry **Waterfall** **Lock**
Trig. Station **Altitude at Trig. Station**
B.M. 325.9 **Bench Mark** **Surface Level**
Arrow denotes flow of water **Antiquities (site of)**
Cutting **Embankment**
Railway crossing Road **Level Crossing** **Road crossing Railway**
Railway crossing River or Canal **Road over single stream** **Road over River or Canal**
County Boundary (Geographical)
County & Civil Parish Boundary
Administrative County & Civil Parish Boundary
County Borough Boundary (England)
County Burgh Boundary (Scotland)
Co. Boro. Bdy.
Co. Burgh Bdy.
BP BS Boundary Post or Stone **P.C.B** Police Call Box
B.R. Bridle Road **P** Pump
E.P Electricity Pylon **S.P** Signal Post
F.B. Foot Bridge **SL** Sluice
F.P. Foot Path **Sp.** Spring
G.P Guide Post or Board **T.C.B** Telephone Call Box
M.S Mile Stone **Tr.** Trough
M.P M.R Mooring Post or Ring **W** Well

Ordnance Survey Plan, Additional SIMs and Supply of Unpublished Survey Information 1:2,500 and 1:1,250

Inactive Quarry, Chalk Pit or Clay Pit **Active Quarry, Chalk Pit or Clay Pit**
Rock **Boulders**
Cliff **Slopes** **Top**
Roofed Building **Glazed Roof Building**
Sloping Masonry **Archway**
Non-Coniferous Tree (surveyed) **Coniferous Tree (surveyed)**
Non-Coniferous Trees (not surveyed) **Coniferous Trees (not surveyed)**
Orchard Tree **Scrub** **Bracken**
Coppice, Osier **Reeds** **Marsh, Saltings**
Rough Grassland **Heath** **Culvert**
Direction of water flow **Bench Mark** **Antiquity (site of)**
Cave Entrance **Triangulation Station** **Electricity Pylon**
Electricity Transmission Line
County Boundary (Geographical)
County & Civil Parish Boundary
Civil Parish Boundary
Admin. County or County Bor. Boundary
London Borough Boundary
Symbol marking point where boundary mereing changes
BH Beer House **P** Pillar, Pole or Post
BP, BS Boundary Post or Stone **PO** Post Office
Cn, C Capstan, Crane **PC** Public Convenience
Chy Chimney **PH** Public House
D Fn Drinking Fountain **Pp** Pump
EI P Electricity Pillar or Post **SB, S Br** Signal Box or Bridge
FAP Fire Alarm Pillar **SP, SL** Signal Post or Light
FB Foot Bridge **Spr** Spring
GP Guide Post **Tk** Tank or Track
H Hydrant or Hydraulic **TCB** Telephone Call Box
LC Level Crossing **TCP** Telephone Call Post
MH Manhole **Tr** Trough
MP Mile Post or Mooring Post **Wr Pt, Wr T** Water Point, Water Tap
MS Mile Stone **W** Well
NTL Normal Tidal Limit **Wd Pp** Wind Pump

Large-Scale National Grid Data 1:2,500 and 1:1,250

Cliff **Slopes** **Top**
Rock **Rock (scattered)**
Boulders **Boulders (scattered)**
Positioned Boulder **Scree**
Non-Coniferous Tree (surveyed) **Coniferous Tree (surveyed)**
Non-Coniferous Trees (not surveyed) **Coniferous Trees (not surveyed)**
Orchard Tree **Scrub** **Bracken**
Coppice, Osier **Reeds** **Marsh, Saltings**
Rough Grassland **Heath** **Culvert**
Direction of water flow **Triangulation Station** **Antiquity (site of)**
Electricity Transmission Line **Electricity Pylon**
B.M. 231.60m Bench Mark **Buildings with Building Seed**
Roofed Building **Glazed Roof Building**
Civil parish/community boundary
District boundary
County boundary
Boundary post/stone
Boundary mereing symbol (note: these always appear in opposed pairs or groups of three)
Bks Barracks **P** Pillar, Pole or Post
Bty Battery **PO** Post Office
Cemy Cemetery **PC** Public Convenience
Chy Chimney **Pp** Pump
Cis Cistern **Ppg Sta** Pumping Station
Dismtd Rly Dismantled Railway **PW** Place of Worship
EI Gen Sta Electricity Generating Station **Sewage Ppg Sta** Sewage Pumping Station
EI P Electricity Pole, Pillar **SB, S Br** Signal Box or Bridge
EI Sub Sta Electricity Sub Station **SP, SL** Signal Post or Light
FB Filter Bed **Spr** Spring
Fn / D Fn Fountain / Drinking Ftn. **Tk** Tank or Track
Gas Gov Gas Valve Compound **Tr** Trough
GVC Gas Governor **Wd Pp** Wind Pump
GP Guide Post **Wr Pt, Wr T** Water Point, Water Tap
MH Manhole **Wks** Works (building or area)
MP, MS Mile Post or Mile Stone **W** Well



Historical Mapping & Photography included:

Mapping Type	Scale	Date	Pg
Lincolnshire	1:2,500	1887	2
Lincolnshire	1:2,500	1907	3
Ordnance Survey Plan	1:2,500	1967	4
Additional SIMs	1:2,500	1978 - 1982	5
Additional SIMs	1:2,500	1991	6
Large-Scale National Grid Data	1:2,500	1994	7
Large-Scale National Grid Data	1:2,500	1995	8
Large-Scale National Grid Data	1:2,500	1995	9
Historical Aerial Photography	1:2,500	1999	10

Historical Map - Segment A8

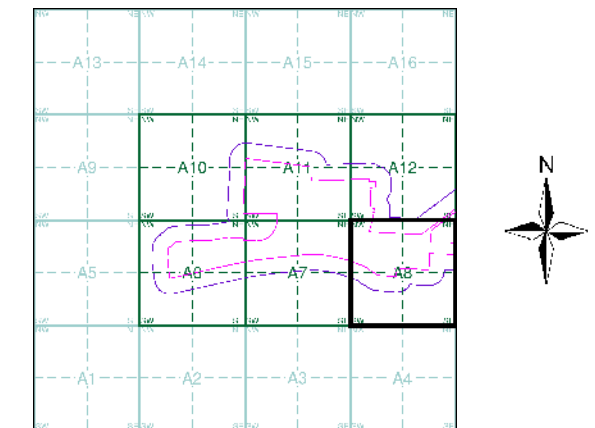

Order Details

Order Number: 242986885_1_1
 Customer Ref: 60625943
 National Grid Reference: 482060, 411790
 Slice: A
 Site Area (Ha): 68.12
 Search Buffer (m): 100

Site Details

Keaddy



Tel: 0844 844 9952
 Fax: 0844 844 9951
 Web: www.envirocheck.co.uk



Lincolnshire

Published 1887

Source map scale - 1:2,500

The historical maps shown were reproduced from maps predominantly held at the scale adopted for England, Wales and Scotland in the 1840's. In 1854 the 1:2,500 scale was adopted for mapping urban areas and by 1896 it covered the whole of what were considered to be the cultivated parts of Great Britain. The published date given below is often some years later than the surveyed date. Before 1938, all OS maps were based on the Cassini Projection, with independent surveys of a single county or group of counties, giving rise to significant inaccuracies in outlying areas.

Map Name(s) and Date(s)

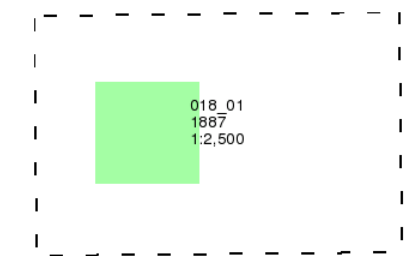

Historical Map - Segment A8

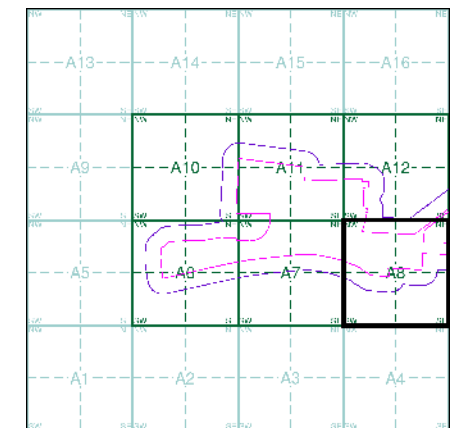

Order Details

Order Number: 242986885_1_1
Customer Ref: 60625943
National Grid Reference: 482060, 411790
Slice: A
Site Area (Ha): 68.12
Search Buffer (m): 100

Site Details

Keadby



Tel: 0844 844 9952
Fax: 0844 844 9951
Web: www.envirocheck.co.uk

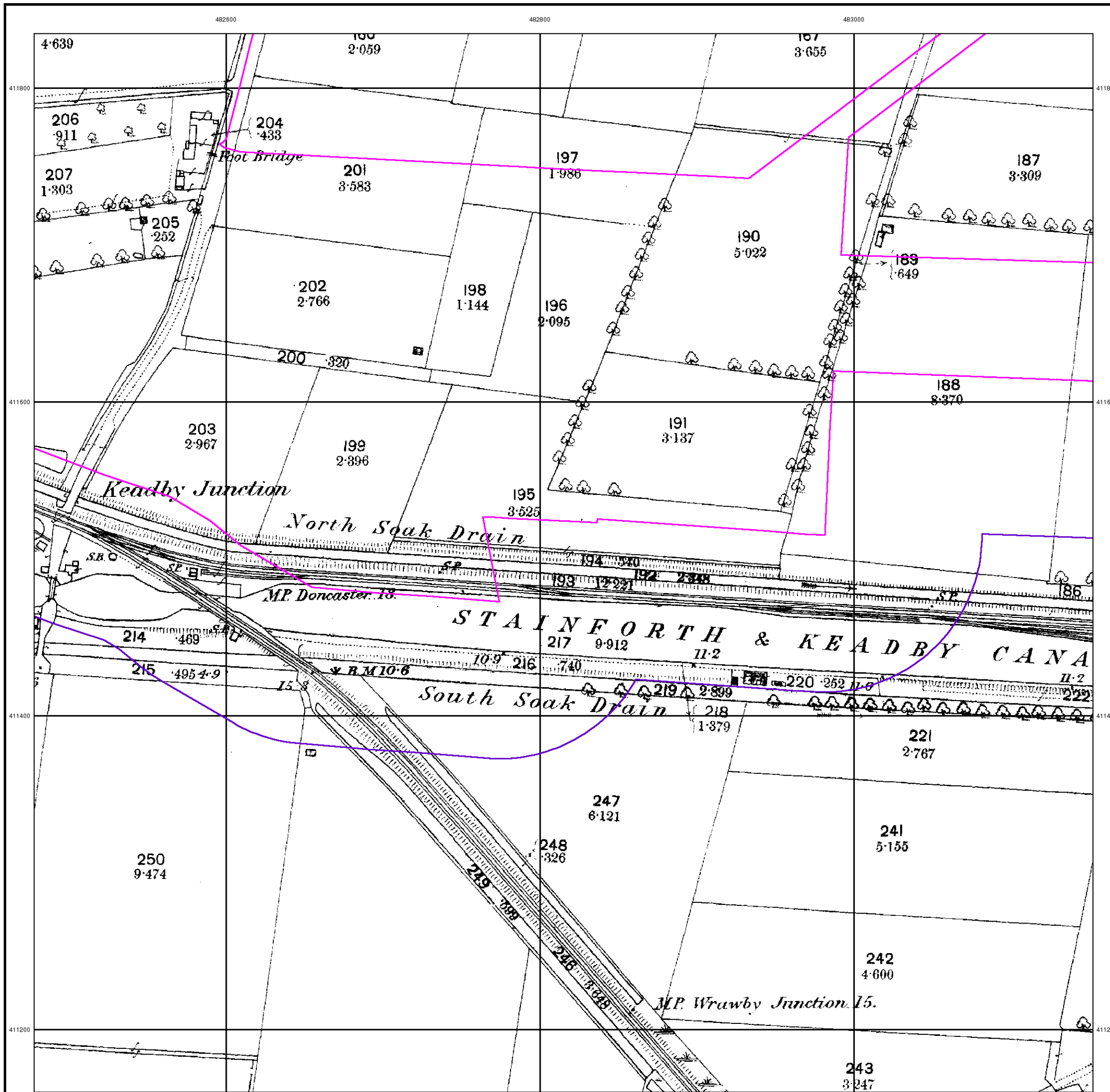



Lincolnshire

Published 1907

Source map scale - 1:2,500

The historical maps shown were reproduced from maps predominantly held at the scale adopted for England, Wales and Scotland in the 1840's. In 1854 the 1:2,500 scale was adopted for mapping urban areas and by 1896 it covered the whole of what were considered to be the cultivated parts of Great Britain. The published date given below is often some years later than the surveyed date. Before 1938, all OS maps were based on the Cassini Projection, with independent surveys of a single county or group of counties, giving rise to significant inaccuracies in outlying areas.

Map Name(s) and Date(s)

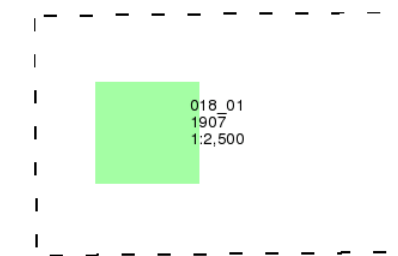

Historical Map - Segment A8

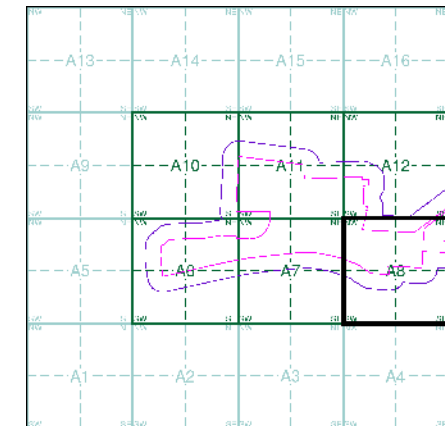

Order Details

Order Number: 242986885_1_1
Customer Ref: 60625943
National Grid Reference: 482060, 411790
Slice: A
Site Area (Ha): 68.12
Search Buffer (m): 100

Site Details

Keadby



Tel: 0844 844 9952
Fax: 0844 844 9951
Web: www.envirocheck.co.uk

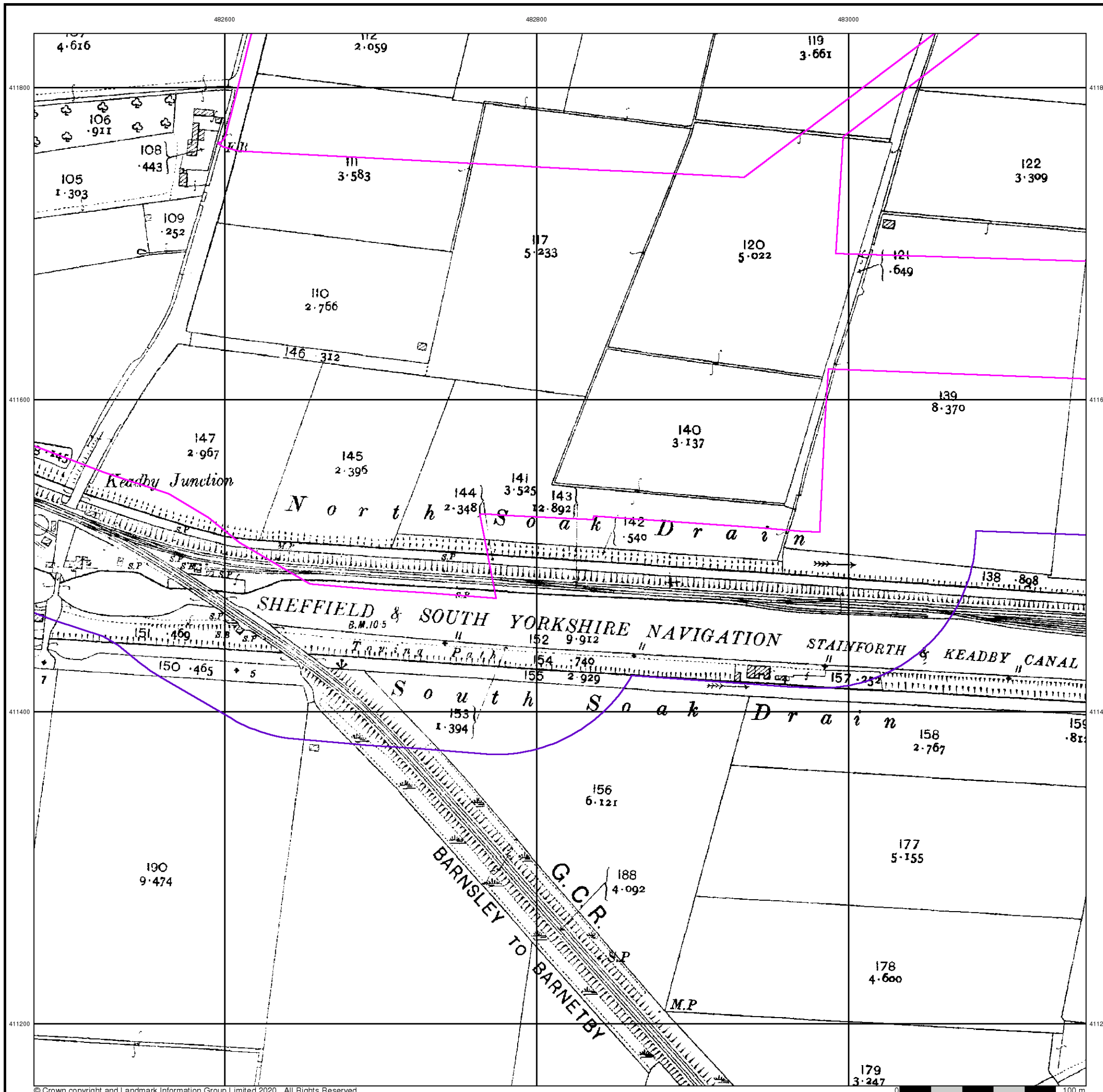



Ordnance Survey Plan

Published 1967

Source map scale - 1:2,500

The historical maps shown were reproduced from maps predominantly held at the scale adopted for England, Wales and Scotland in the 1840's. In 1854 the 1:2,500 scale was adopted for mapping urban areas and by 1896 it covered the whole of what were considered to be the cultivated parts of Great Britain. The published date given below is often some years later than the surveyed date. Before 1938, all OS maps were based on the Cassini Projection, with independent surveys of a single county or group of counties, giving rise to significant inaccuracies in outlying areas.

Map Name(s) and Date(s)

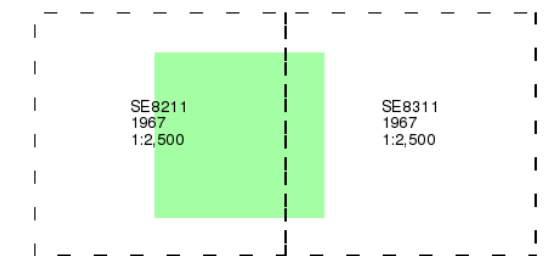

Historical Map - Segment A8

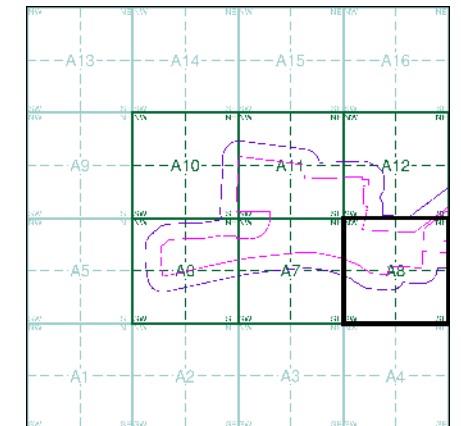

Order Details

Order Number: 242986885_1_1
Customer Ref: 60625943
National Grid Reference: 482060, 411790
Slice: A
Site Area (Ha): 68.12
Search Buffer (m): 100

Site Details

Keadby



Tel: 0844 844 9952
Fax: 0844 844 9951
Web: www.envirocheck.co.uk

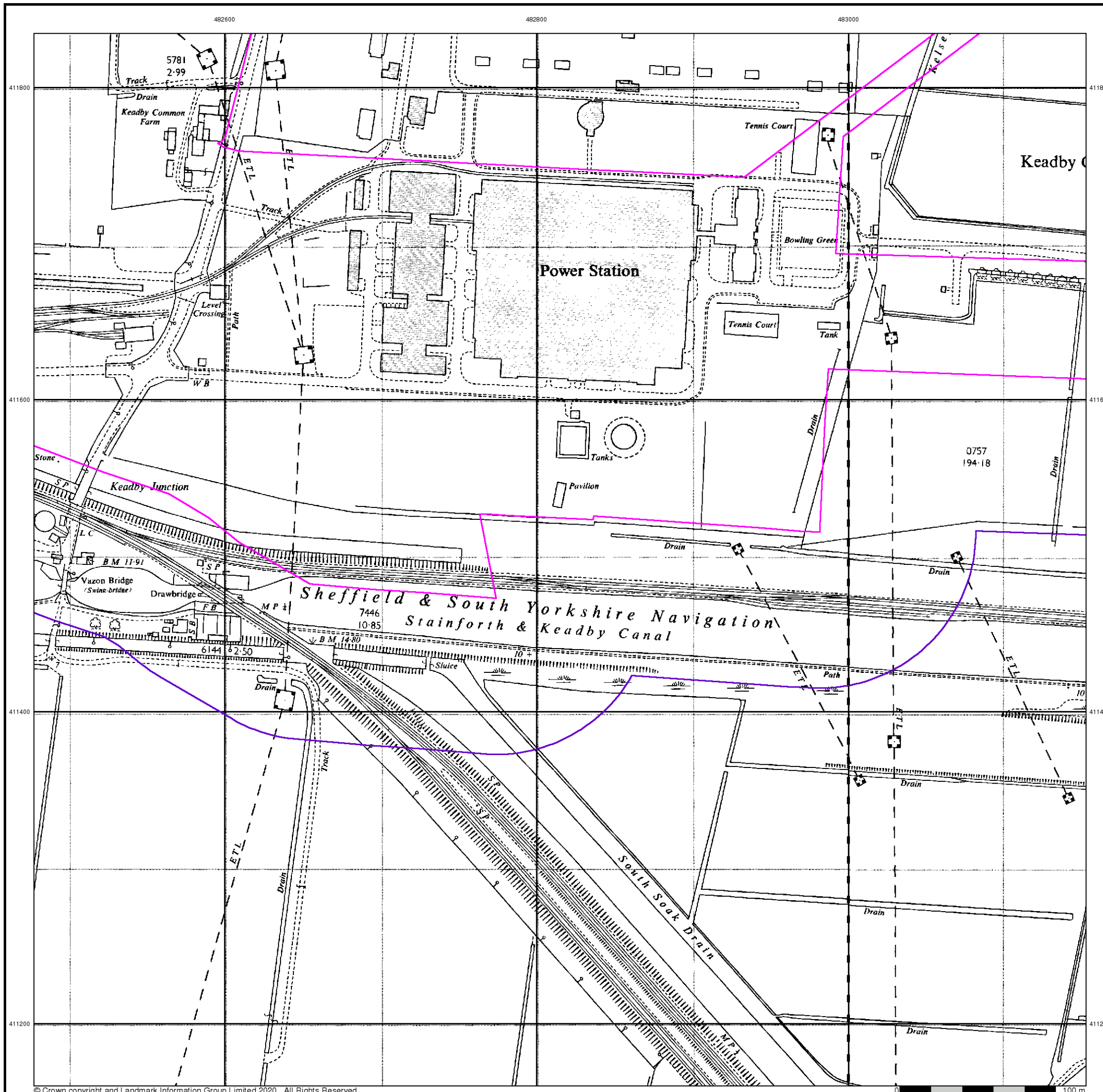



Additional SIMs

Published 1978 - 1982

Source map scale - 1:2,500

The SIM cards (Ordnance Survey's 'Survey of Information on Microfilm') are further, minor editions of mapping which were produced and published in between the main editions as an area was updated. They date from 1947 to 1994, and contain detailed information on buildings, roads and land-use. These maps were produced at both 1:2,500 and 1:1,250 scales.

Map Name(s) and Date(s)

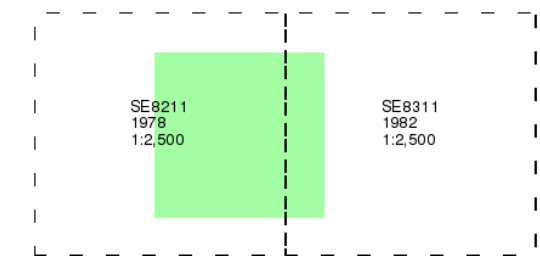

Historical Map - Segment A8

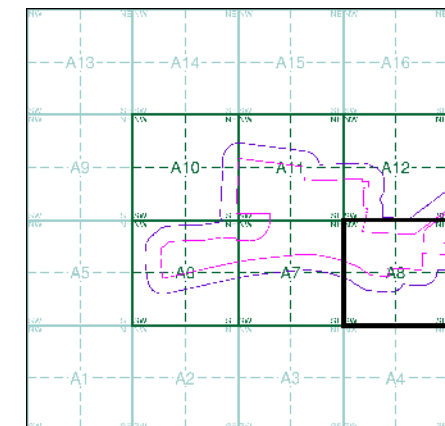

Order Details

Order Number: 242986885_1_1
 Customer Ref: 60625943
 National Grid Reference: 482060, 411790
 Slice: A
 Site Area (Ha): 68.12
 Search Buffer (m): 100

Site Details

Keadby



Tel: 0844 844 9952
 Fax: 0844 844 9951
 Web: www.envirocheck.co.uk

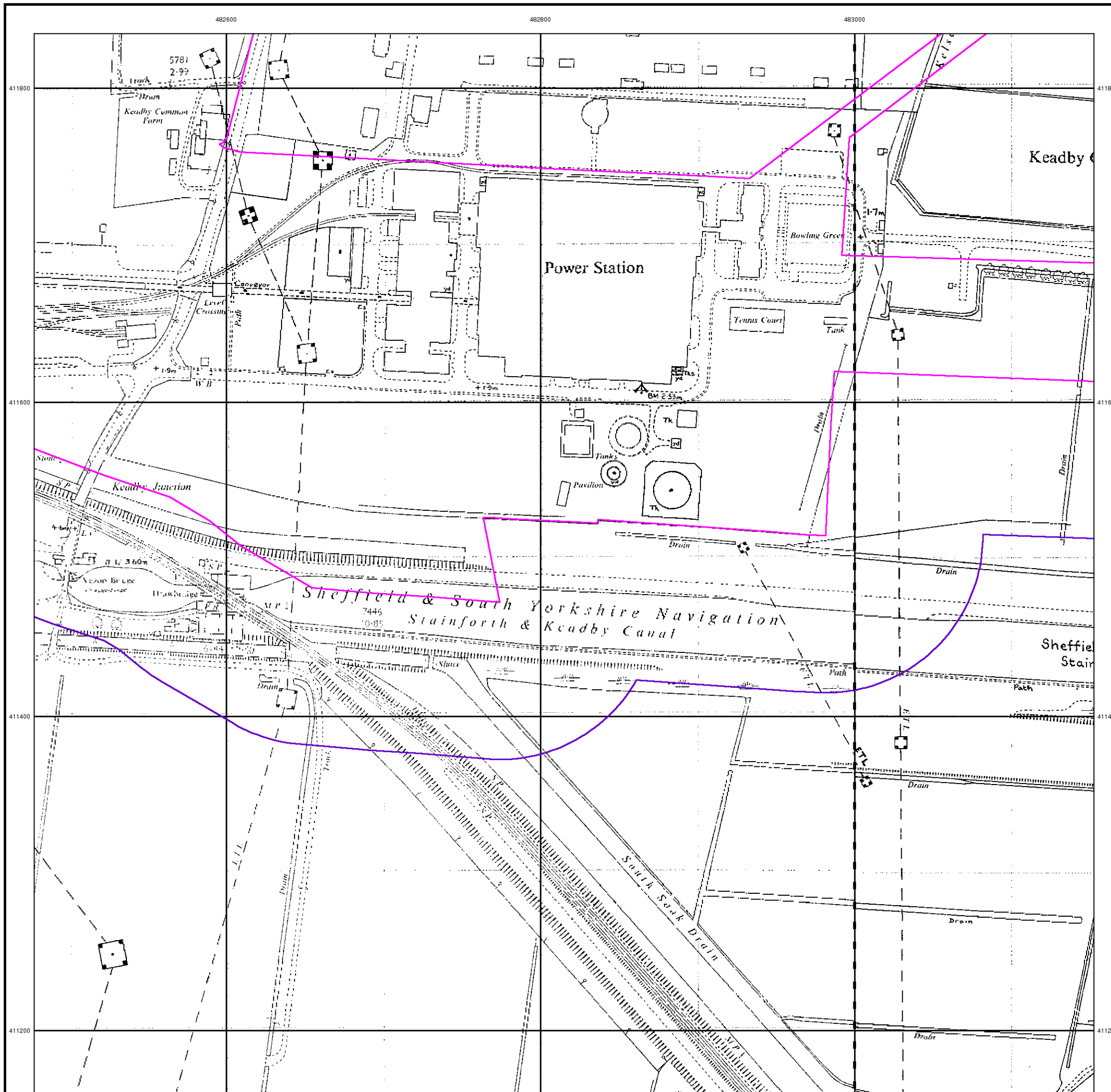



Additional SIMs

Published 1991

Source map scale - 1:2,500

The SIM cards (Ordnance Survey's 'Survey of Information on Microfilm') are further, minor editions of mapping which were produced and published in between the main editions as an area was updated. They date from 1947 to 1994, and contain detailed information on buildings, roads and land-use. These maps were produced at both 1:2,500 and 1:1,250 scales.

Map Name(s) and Date(s)

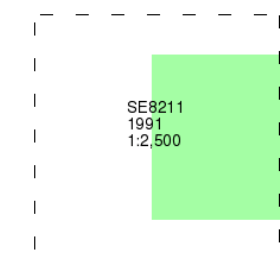

Historical Map - Segment A8

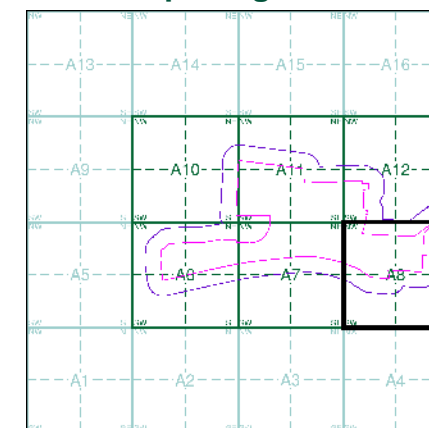

Order Details

Order Number:	242986885_1_1
Customer Ref:	60625943
National Grid Reference:	482060, 411790
Slice:	A
Site Area (Ha):	68.12
Search Buffer (m):	100

Site Details

Keadby



Tel:	0844 844 9952
Fax:	0844 844 9951
Web:	www.envirocheck.co.uk

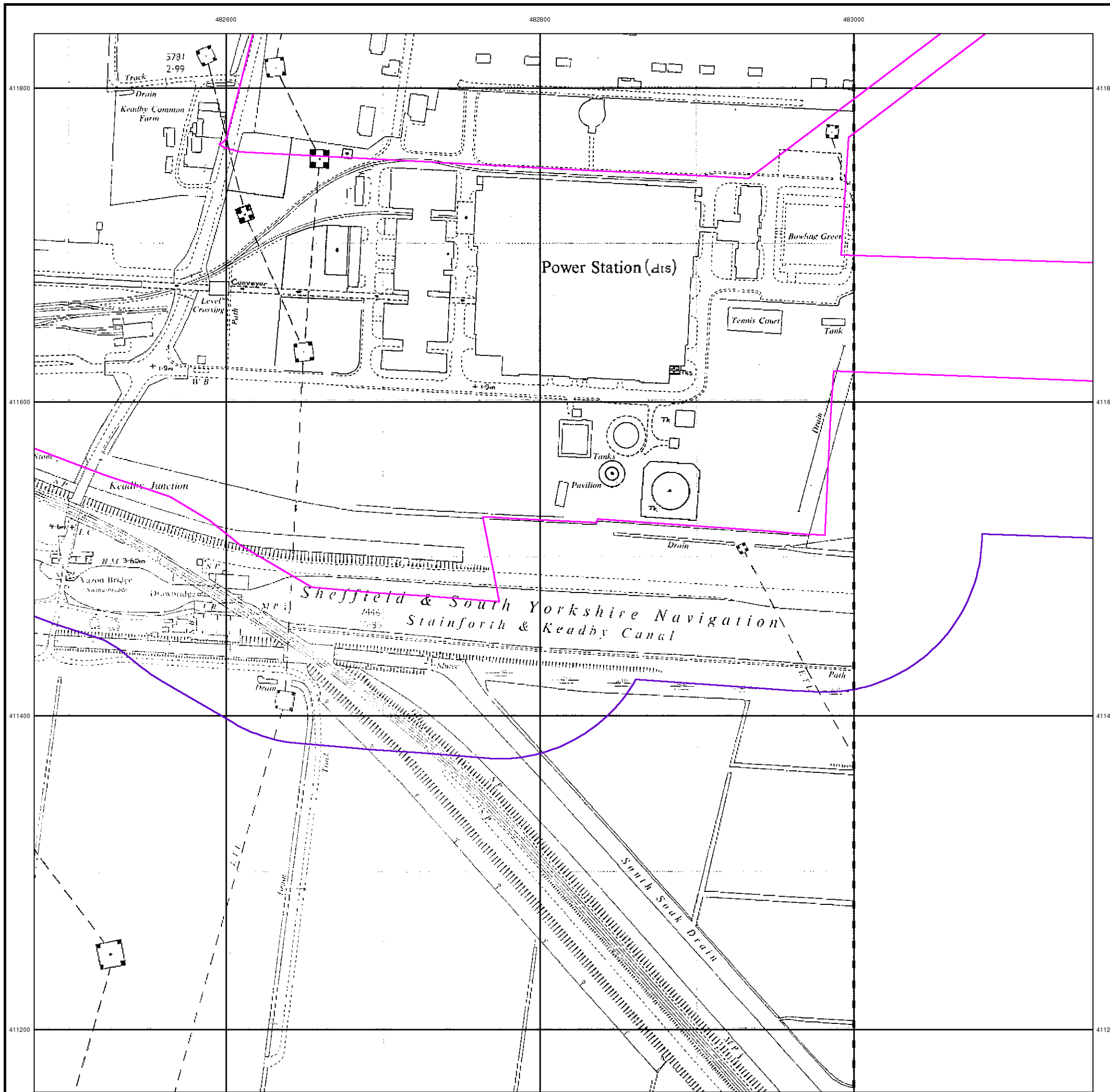



Large-Scale National Grid Data

Published 1994

Source map scale - 1:2,500

'Large Scale National Grid Data' superseded SIM cards (Ordnance Survey's 'Survey of Information on Microfilm') in 1992, and continued to be produced until 1999. These maps were the fore-runners of digital mapping and so provide detailed information on houses and roads, but tend to show less topographic features such as vegetation. These maps were produced at both 1:2,500 and 1:1,250 scales.

Map Name(s) and Date(s)

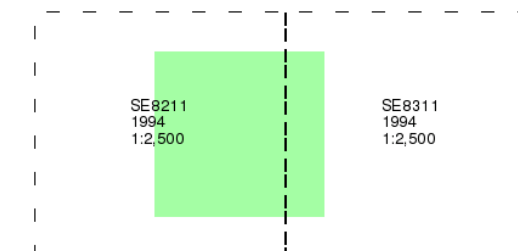

Historical Map - Segment A8

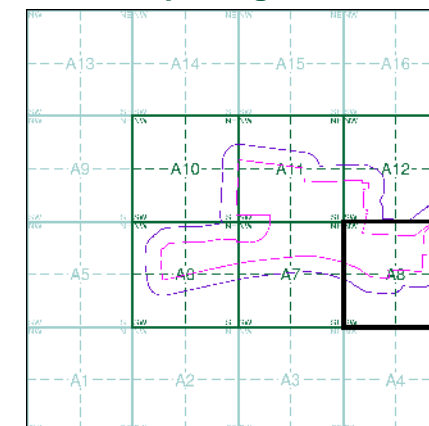

Order Details

Order Number: 242986885_1_1
Customer Ref: 60625943
National Grid Reference: 482060, 411790
Slice: A
Site Area (Ha): 68.12
Search Buffer (m): 100

Site Details

Keadby



Tel: 0844 844 9952
Fax: 0844 844 9951
Web: www.envirocheck.co.uk



482600

482800

483000



Historical Aerial Photography

Published 1999

This aerial photography was produced by Getmapping, these vertical aerial photographs provide a seamless, full colour survey of the whole of Great Britain



Historical Aerial Photography - Segment A8

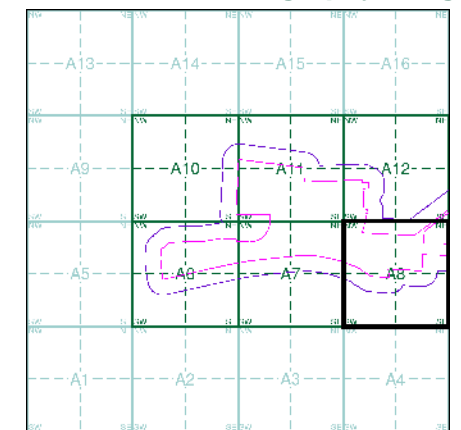

Order Details

Order Number:	242986885_1_1
Customer Ref:	60625943
National Grid Reference:	482060, 411790
Slice:	A
Site Area (Ha):	68.12
Search Buffer (m):	100

Site Details

Keadby



Tel:	0844 844 9952
Fax:	0844 844 9951
Web:	www.envirocheck.co.uk

Historical Mapping Legends

Ordnance Survey County Series and Ordnance Survey Plan 1:2,500

Quarry **Gravel Pit** **Sand Pit**
Clay Pit **Shingle** **Refuse Heap**
Sloping Masonry **Flat Rock**
Marsh **Reeds** **Osiers**
Rough Pasture **Furze** **Wood**
Mixed Wood **Brushwood** **Orchard**
Fir **Ford** **Stepping Stones**
Ferry **Waterfall** **Lock**
Trig. Station **Altitude at Trig. Station**
B.M. 325.9 **Bench Mark** **Surface Level**
Arrow denotes flow of water **Antiquities (site of)**
Cutting **Embankment**
Railway crossing Road **Level Crossing** **Road crossing Railway**
Railway crossing River or Canal **Road over single stream** **Road over River or Canal**
County Boundary (Geographical)
County & Civil Parish Boundary
Administrative County & Civil Parish Boundary
County Borough Boundary (England)
County Burgh Boundary (Scotland)
Co. Boro. Bdy.
Co. Burgh Bdy.
BP BS Boundary Post or Stone **P.C.B** Police Call Box
B.R. Bridle Road **P** Pump
E.P Electricity Pylon **S.P** Signal Post
F.B. Foot Bridge **SL** Sluice
F.P. Foot Path **Sp.** Spring
G.P Guide Post or Board **T.C.B** Telephone Call Box
M.S Mile Stone **Tr.** Trough
M.P M.R Mooring Post or Ring **W** Well

Ordnance Survey Plan, Additional SIMs and Supply of Unpublished Survey Information 1:2,500 and 1:1,250

Inactive Quarry, Chalk Pit or Clay Pit **Active Quarry, Chalk Pit or Clay Pit**
Rock **Boulders**
Cliff **Slopes** **Top**
Roofed Building **Glazed Roof Building**
Sloping Masonry **Archway**
Non-Coniferous Tree (surveyed) **Coniferous Tree (surveyed)**
Non-Coniferous Trees (not surveyed) **Coniferous Trees (not surveyed)**
Orchard Tree **Scrub** **Bracken**
Coppice, Osier **Reeds** **Marsh, Saltings**
Rough Grassland **Heath** **Culvert**
Direction of water flow **Bench Mark** **Antiquity (site of)**
Cave Entrance **Triangulation Station** **Electricity Pylon**
Electricity Transmission Line
County Boundary (Geographical)
County & Civil Parish Boundary
Civil Parish Boundary
Admin. County or County Bor. Boundary
London Borough Boundary
Symbol marking point where boundary mereing changes
BH Beer House **P** Pillar, Pole or Post
BP, BS Boundary Post or Stone **PO** Post Office
Cn, C Capstan, Crane **PC** Public Convenience
Chy Chimney **PH** Public House
D Fn Drinking Fountain **Pp** Pump
EI P Electricity Pillar or Post **SB, S Br** Signal Box or Bridge
FAP Fire Alarm Pillar **SP, SL** Signal Post or Light
FB Foot Bridge **Spr** Spring
GP Guide Post **Tk** Tank or Track
H Hydrant or Hydraulic **TCB** Telephone Call Box
LC Level Crossing **TCP** Telephone Call Post
MH Manhole **Tr** Trough
MP Mile Post or Mooring Post **Wr Pt, Wr T** Water Point, Water Tap
MS Mile Stone **W** Well
NTL Normal Tidal Limit **Wd Pp** Wind Pump

Large-Scale National Grid Data 1:2,500 and 1:1,250

Cliff **Slopes** **Top**
Rock **Rock (scattered)**
Boulders **Boulders (scattered)**
Positioned Boulder **Scree**
Non-Coniferous Tree (surveyed) **Coniferous Tree (surveyed)**
Non-Coniferous Trees (not surveyed) **Coniferous Trees (not surveyed)**
Orchard Tree **Scrub** **Bracken**
Coppice, Osier **Reeds** **Marsh, Saltings**
Rough Grassland **Heath** **Culvert**
Direction of water flow **Triangulation Station** **Antiquity (site of)**
Electricity Transmission Line **Electricity Pylon**
BM 231.60m Bench Mark **Buildings with Building Seed**
Roofed Building **Glazed Roof Building**
Civil parish/community boundary
District boundary
County boundary
Boundary post/stone
Boundary mereing symbol (note: these always appear in opposed pairs or groups of three)
Bks Barracks **P** Pillar, Pole or Post
Bty Battery **PO** Post Office
Cemy Cemetery **PC** Public Convenience
Chy Chimney **Pp** Pump
Cis Cistern **Ppg Sta** Pumping Station
Dismtd Rly Dismantled Railway **PW** Place of Worship
EI Gen Sta Electricity Generating Station **Sewage Ppg Sta** Sewage Pumping Station
EI P Electricity Pole, Pillar **SB, S Br** Signal Box or Bridge
EI Sub Sta Electricity Sub Station **SP, SL** Signal Post or Light
FB Filter Bed **Spr** Spring
Fn / D Fn Fountain / Drinking Ftn. **Tk** Tank or Track
Gas Gov Gas Valve Compound **Tr** Trough
GVC Gas Governor **Wd Pp** Wind Pump
GP Guide Post **Wr Pt, Wr T** Water Point, Water Tap
MH Manhole **Wks** Works (building or area)
MP, MS Mile Post or Mile Stone **W** Well



Historical Mapping & Photography included:

Mapping Type	Scale	Date	Pg
Lincolnshire	1:2,500	1886	2
Lincolnshire	1:2,500	1907	3
Ordnance Survey Plan	1:2,500	1966 - 1967	4
Additional SIMs	1:2,500	1966 - 1967	5
Large-Scale National Grid Data	1:2,500	1994	6
Large-Scale National Grid Data	1:2,500	1995	7
Large-Scale National Grid Data	1:2,500	1996	8
Historical Aerial Photography	1:2,500	1999	9

Historical Map - Segment A10

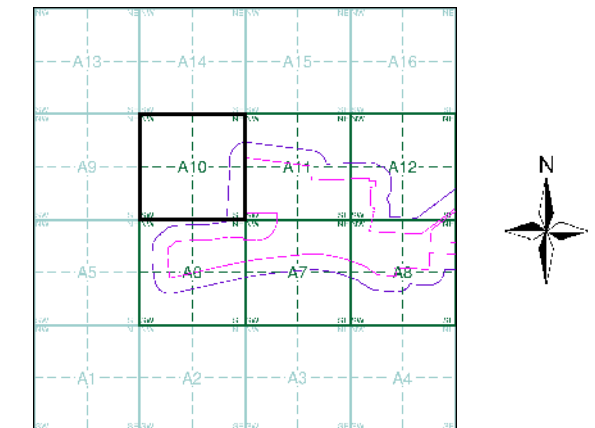

Order Details

Order Number: 242986885_1_1
 Customer Ref: 60625943
 National Grid Reference: 482060, 411790
 Slice: A
 Site Area (Ha): 68.12
 Search Buffer (m): 100

Site Details

Keaddy



Tel: 0844 844 9952
 Fax: 0844 844 9951
 Web: www.envirocheck.co.uk



Lincolnshire

Published 1886

Source map scale - 1:2,500

The historical maps shown were reproduced from maps predominantly held at the scale adopted for England, Wales and Scotland in the 1840's. In 1854 the 1:2,500 scale was adopted for mapping urban areas and by 1896 it covered the whole of what were considered to be the cultivated parts of Great Britain. The published date given below is often some years later than the surveyed date. Before 1938, all OS maps were based on the Cassini Projection, with independent surveys of a single county or group of counties, giving rise to significant inaccuracies in outlying areas.

Map Name(s) and Date(s)

009_16	1886	1:2,500
017_04	1886	1:2,500

Historical Map - Segment A10

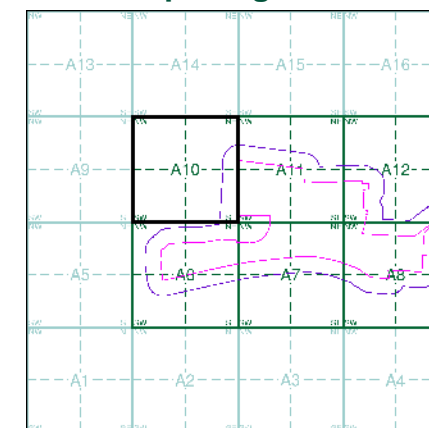

Order Details

Order Number: 242986885_1_1
 Customer Ref: 60625943
 National Grid Reference: 482060, 411790
 Slice: A
 Site Area (Ha): 68.12
 Search Buffer (m): 100

Site Details

Keadby



Tel: 0844 844 9952
 Fax: 0844 844 9951
 Web: www.envirocheck.co.uk

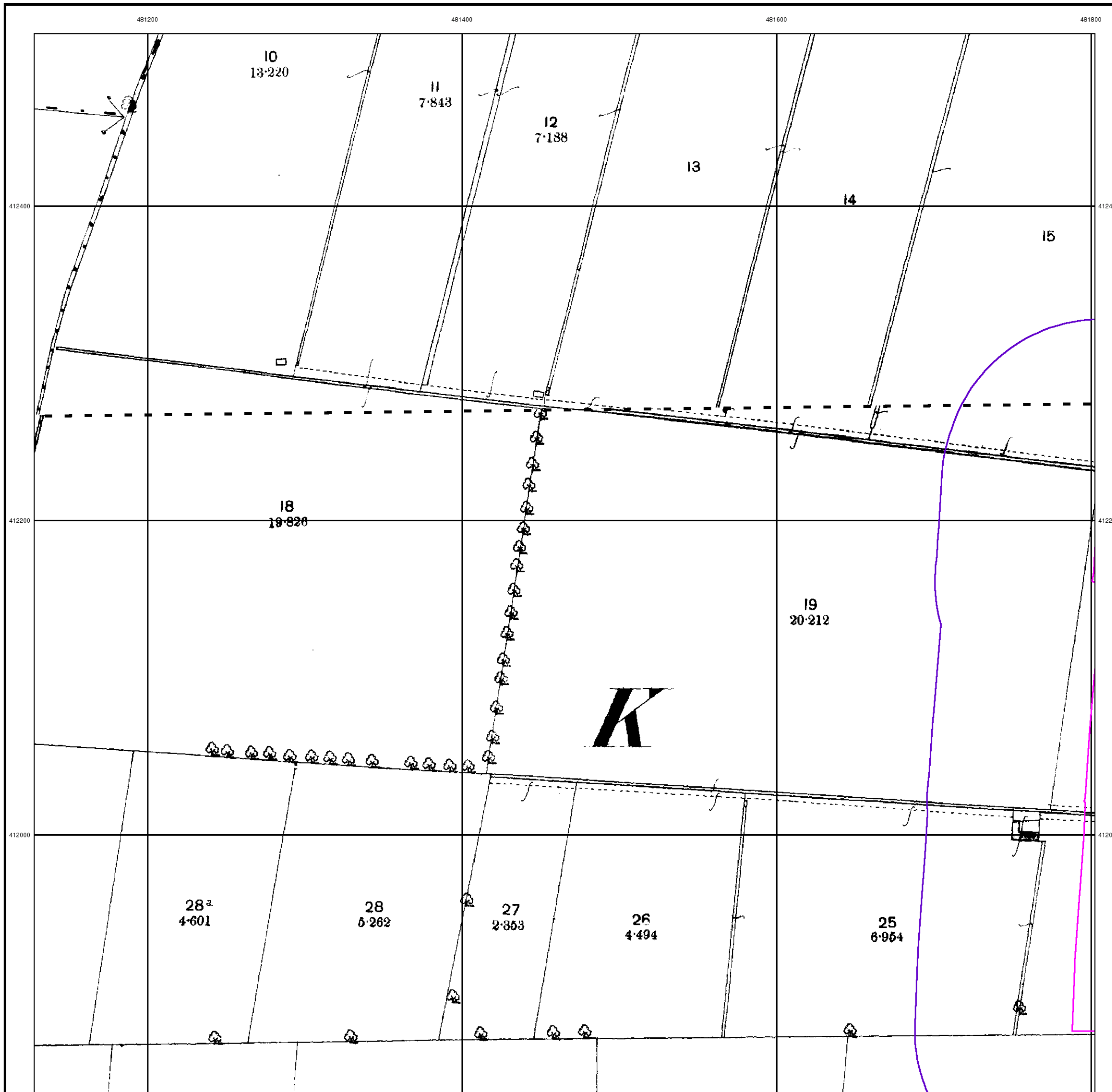



Lincolnshire

Published 1907

Source map scale - 1:2,500

The historical maps shown were reproduced from maps predominantly held at the scale adopted for England, Wales and Scotland in the 1840's. In 1854 the 1:2,500 scale was adopted for mapping urban areas and by 1896 it covered the whole of what were considered to be the cultivated parts of Great Britain. The published date given below is often some years later than the surveyed date. Before 1938, all OS maps were based on the Cassini Projection, with independent surveys of a single county or group of counties, giving rise to significant inaccuracies in outlying areas.

Map Name(s) and Date(s)

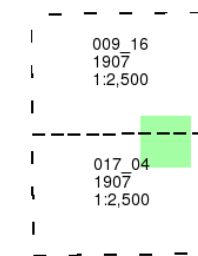

Historical Map - Segment A10

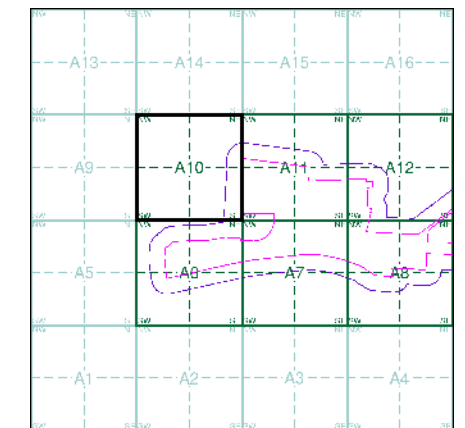

Order Details

Order Number: 242986885_1_1
Customer Ref: 60625943
National Grid Reference: 482060, 411790
Slice: A
Site Area (Ha): 68.12
Search Buffer (m): 100

Site Details

Keadby



Tel: 0844 844 9952
Fax: 0844 844 9951
Web: www.envirocheck.co.uk

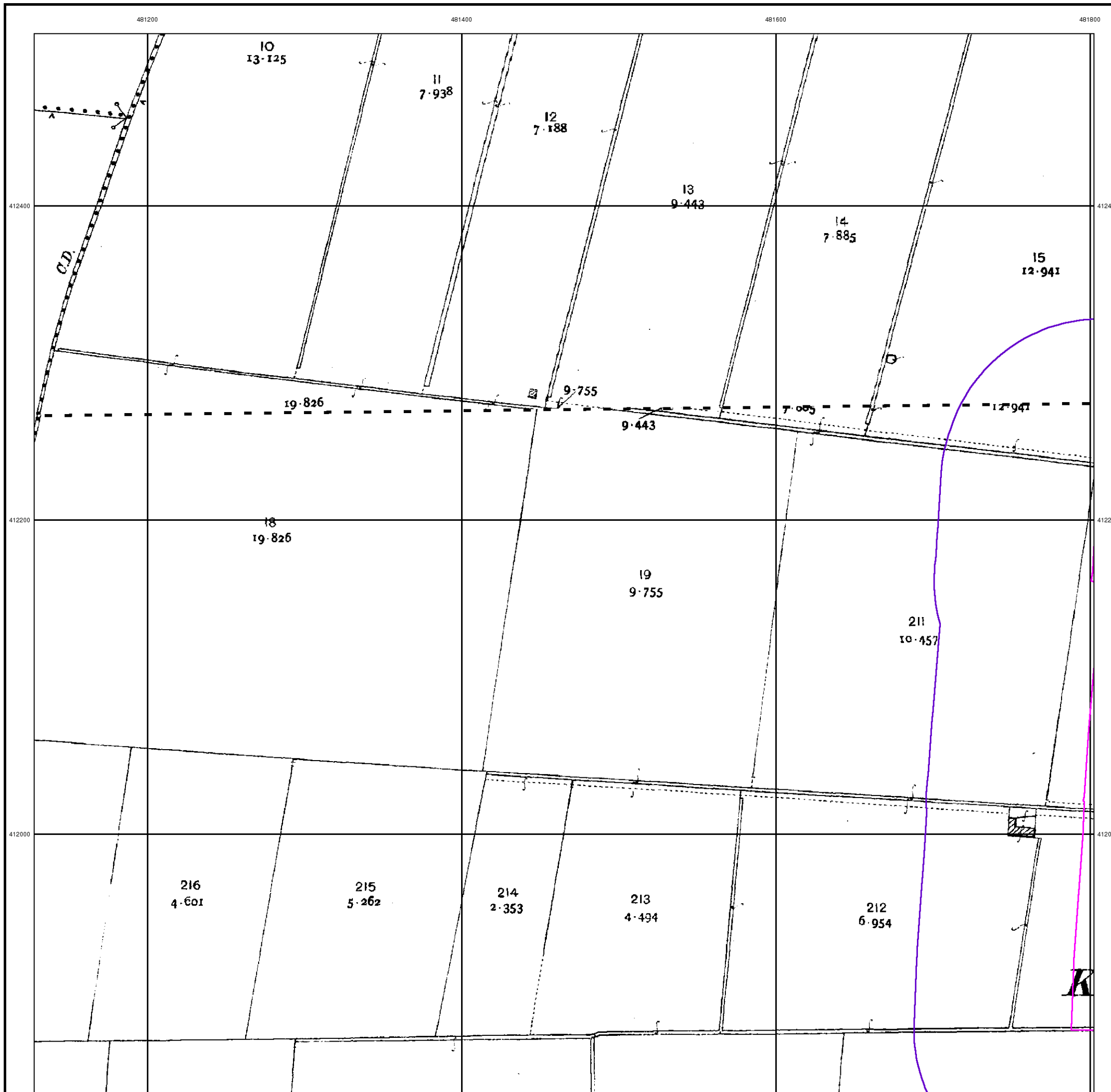



Ordnance Survey Plan
Published 1966 - 1967
Source map scale - 1:2,500

The historical maps shown were reproduced from maps predominantly held at the scale adopted for England, Wales and Scotland in the 1840's. In 1854 the 1:2,500 scale was adopted for mapping urban areas and by 1896 it covered the whole of what were considered to be the cultivated parts of Great Britain. The published date given below is often some years later than the surveyed date. Before 1938, all OS maps were based on the Cassini Projection, with independent surveys of a single county or group of counties, giving rise to significant inaccuracies in outlying areas.

Map Name(s) and Date(s)

SE8112
1966
1:2,500
SE8111
1967
1:2,500

Historical Map - Segment A10

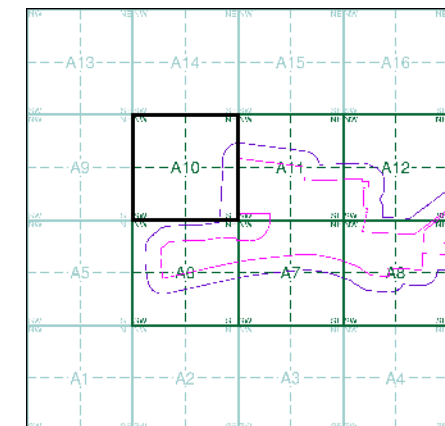

Order Details

Order Number: 242986885_1_1
Customer Ref: 60625943
National Grid Reference: 482060, 411790
Slice: A
Site Area (Ha): 68.12
Search Buffer (m): 100

Site Details

Keadby



Tel: 0844 844 9952
Fax: 0844 844 9951
Web: www.envirocheck.co.uk

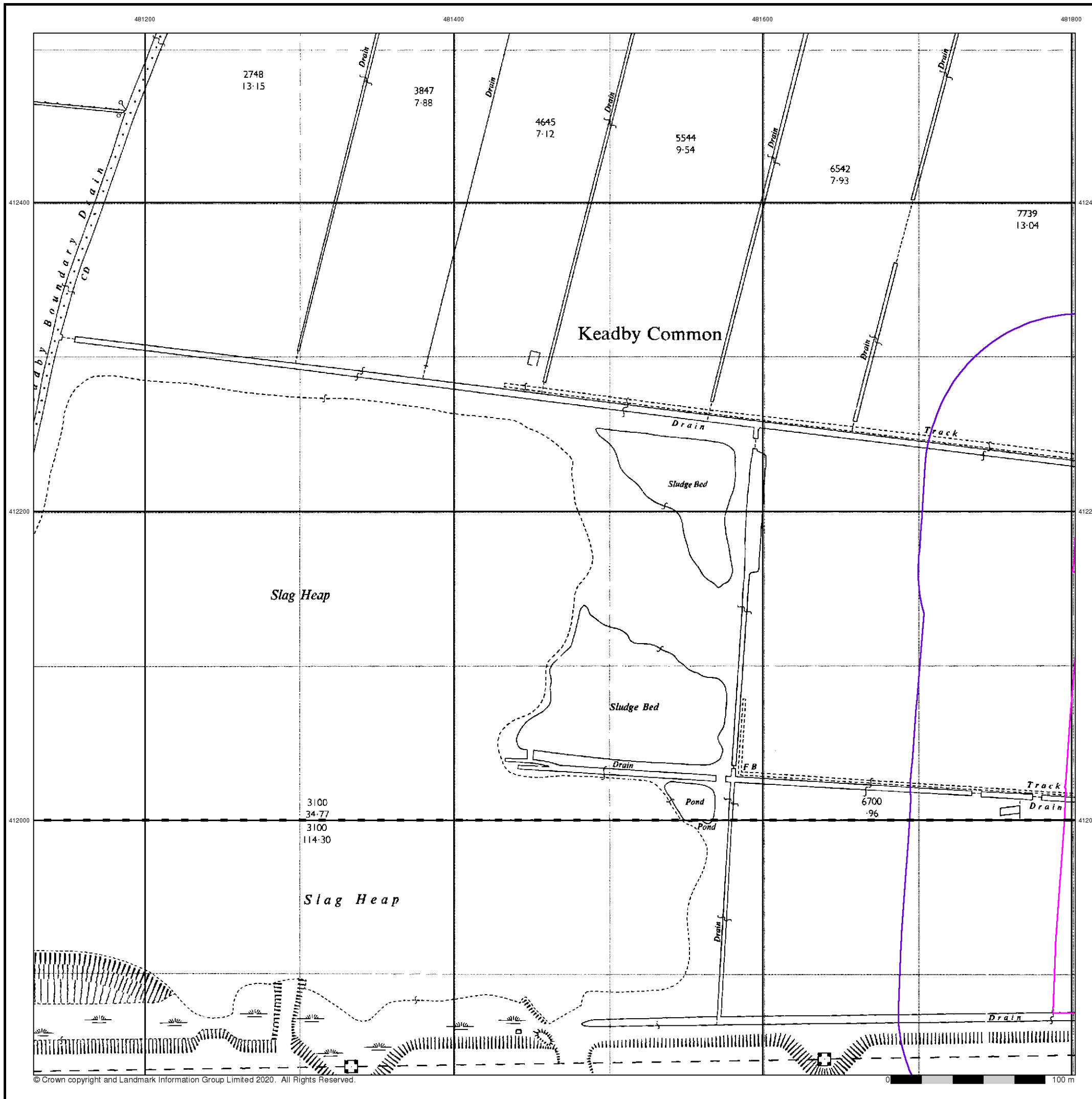



Additional SIMs

Published 1966 - 1967

Source map scale - 1:2,500

The SIM cards (Ordnance Survey's 'Survey of Information on Microfilm') are further, minor editions of mapping which were produced and published in between the main editions as an area was updated. They date from 1947 to 1994, and contain detailed information on buildings, roads and land-use. These maps were produced at both 1:2,500 and 1:1,250 scales.

Map Name(s) and Date(s)

SE8112	1966	1:2,500
SE8111	1967	1:2,500

Historical Map - Segment A10

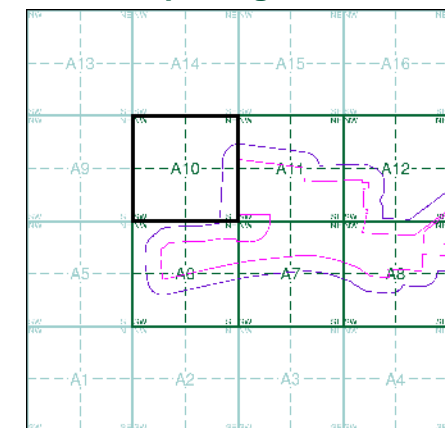

Order Details

Order Number: 242986885_1_1
 Customer Ref: 60625943
 National Grid Reference: 482060, 411790
 Slice: A
 Site Area (Ha): 68.12
 Search Buffer (m): 100

Site Details

Keadby



Tel: 0844 844 9952
 Fax: 0844 844 9951
 Web: www.envirocheck.co.uk

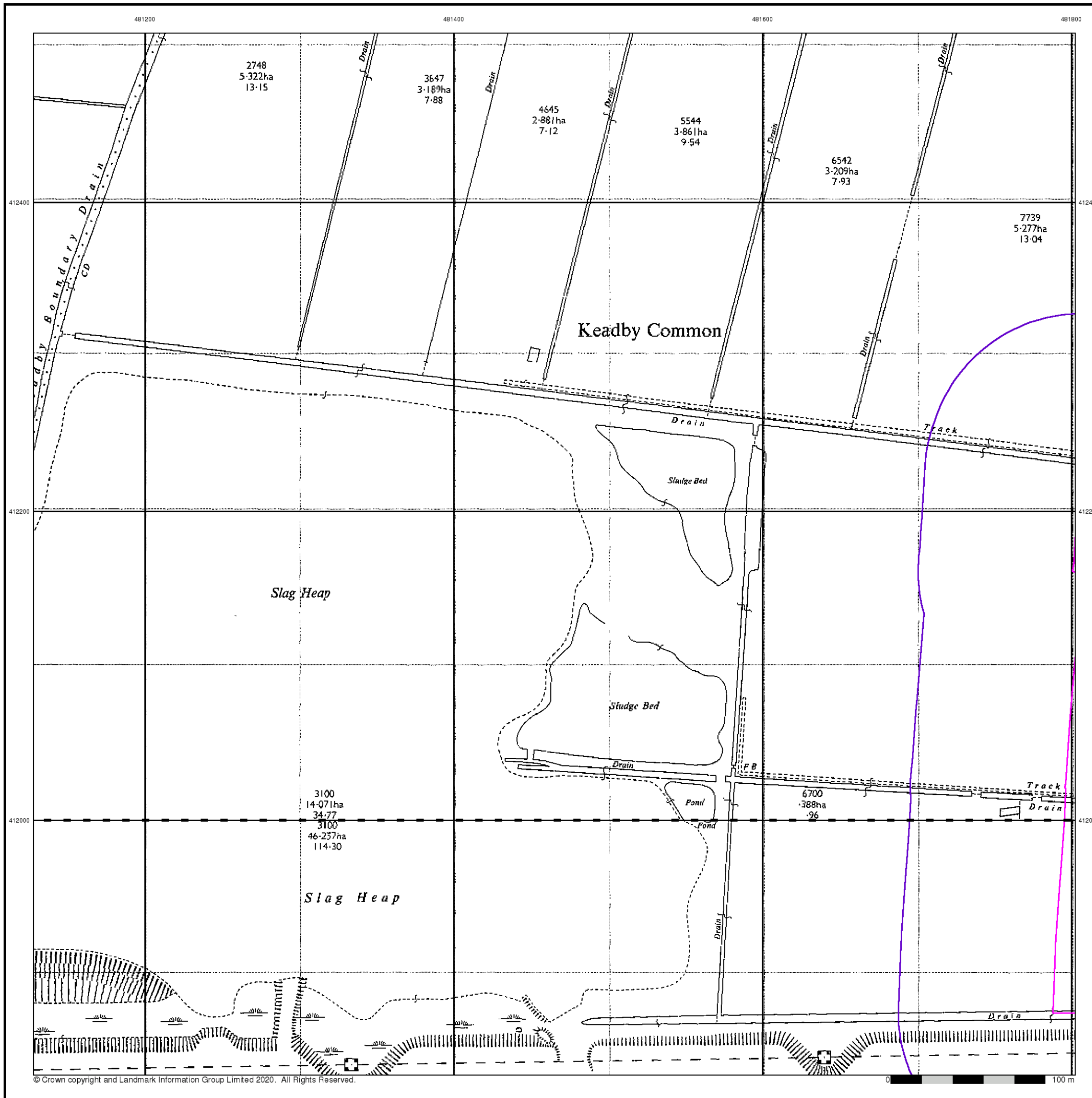



Large-Scale National Grid Data

Published 1994

Source map scale - 1:2,500

'Large Scale National Grid Data' superseded SIM cards (Ordnance Survey's 'Survey of Information on Microfilm') in 1992, and continued to be produced until 1999. These maps were the fore-runners of digital mapping and so provide detailed information on houses and roads, but tend to show less topographic features such as vegetation. These maps were produced at both 1:2,500 and 1:1,250 scales.

Map Name(s) and Date(s)

SE8112	1994	1:2,500
SE8111	1994	1:2,500

Historical Map - Segment A10

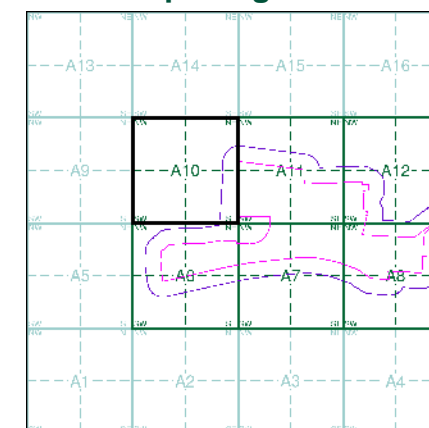

Order Details

Order Number: 242986885_1_1
 Customer Ref: 60625943
 National Grid Reference: 482060, 411790
 Slice: A
 Site Area (Ha): 68.12
 Search Buffer (m): 100

Site Details

Keadby



Tel: 0844 844 9952
 Fax: 0844 844 9951
 Web: www.envirocheck.co.uk

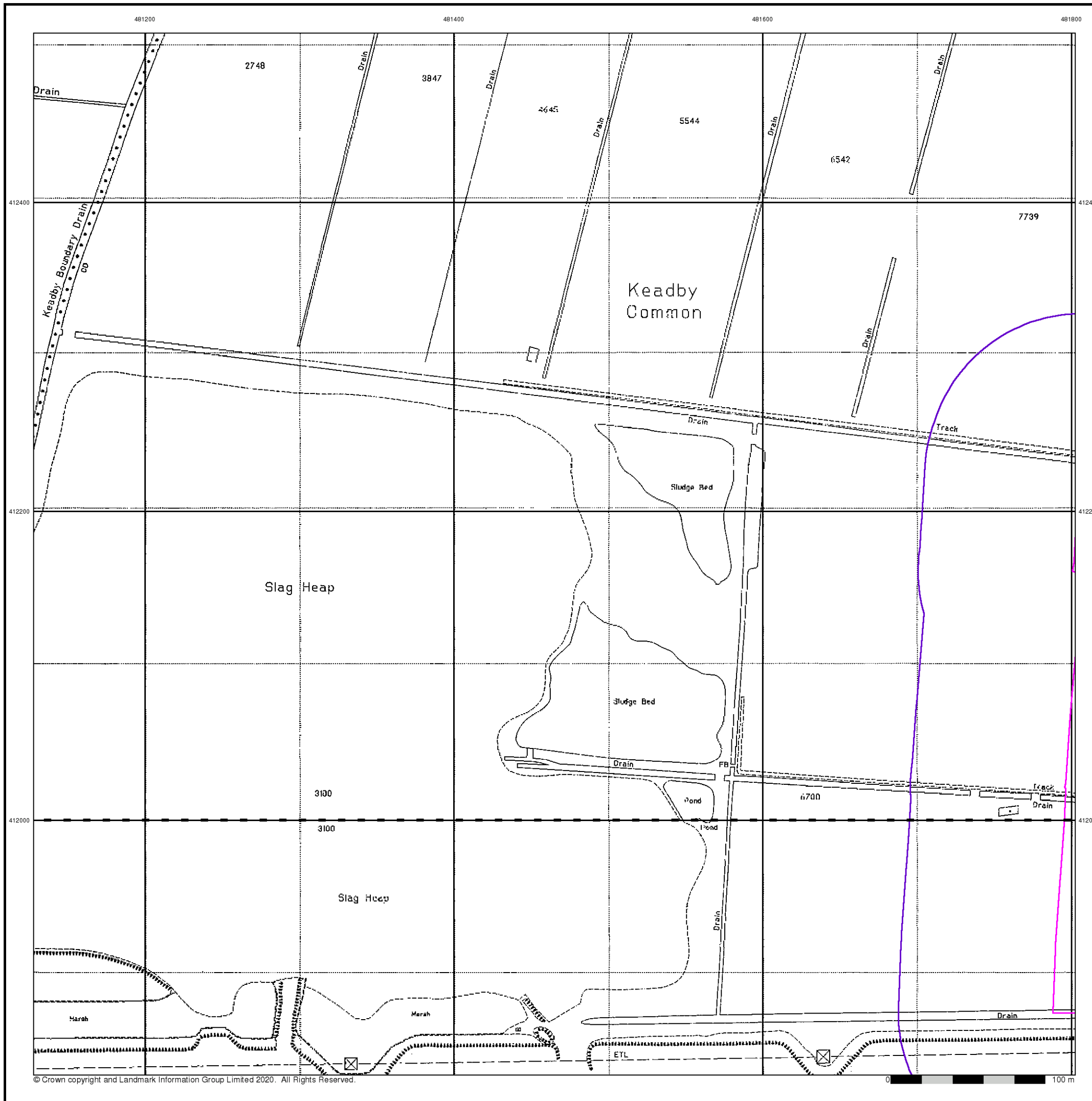



Large-Scale National Grid Data

Published 1995

Source map scale - 1:2,500

'Large Scale National Grid Data' superseded SIM cards (Ordnance Survey's 'Survey of Information on Microfilm') in 1992, and continued to be produced until 1999. These maps were the fore-runners of digital mapping and so provide detailed information on houses and roads, but tend to show less topographic features such as vegetation. These maps were produced at both 1:2,500 and 1:1,250 scales.

Map Name(s) and Date(s)

SE8112	
1995	
1:2,500	
SE8111	
1995	
1:2,500	

Historical Map - Segment A10

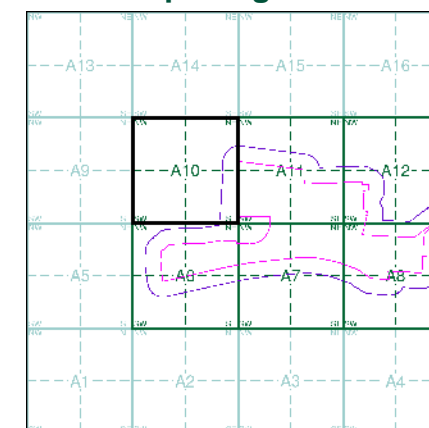

Order Details

Order Number: 242986885_1_1
Customer Ref: 60625943
National Grid Reference: 482060, 411790
Slice: A
Site Area (Ha): 68.12
Search Buffer (m): 100

Site Details

Keadby



Tel: 0844 844 9952
Fax: 0844 844 9951
Web: www.envirocheck.co.uk





Large-Scale National Grid Data

Published 1996

Source map scale - 1:2,500

'Large Scale National Grid Data' superseded SIM cards (Ordnance Survey's 'Survey of Information on Microfilm') in 1992, and continued to be produced until 1999. These maps were the fore-runners of digital mapping and so provide detailed information on houses and roads, but tend to show less topographic features such as vegetation. These maps were produced at both 1:2,500 and 1:1,250 scales.

Map Name(s) and Date(s)

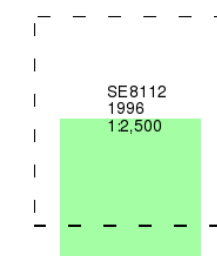

Historical Map - Segment A10

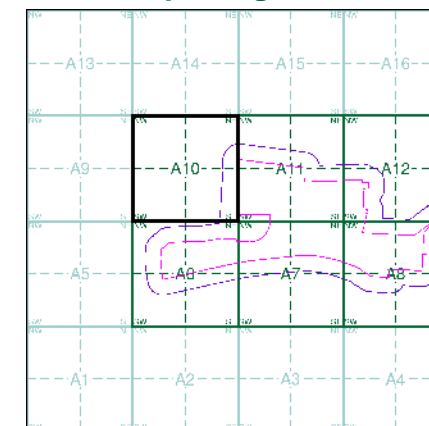

Order Details

Order Number: 242986885_1_1
 Customer Ref: 60625943
 National Grid Reference: 482060, 411790
 Slice: A
 Site Area (Ha): 68.12
 Search Buffer (m): 100

Site Details

Keadby



Tel: 0844 844 9952
 Fax: 0844 844 9951
 Web: www.envirocheck.co.uk



481200

481400

481600

481800



Historical Aerial Photography

Published 1999

This aerial photography was produced by Getmapping, these vertical aerial photographs provide a seamless, full colour survey of the whole of Great Britain

412400

412400

412200

412200

412000

412000



Historical Aerial Photography - Segment A10

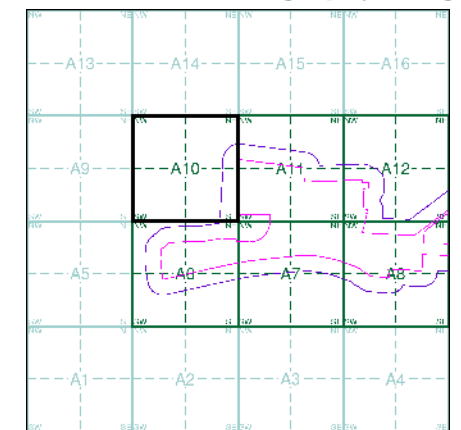

Order Details

Order Number: 242986885_1_1
 Customer Ref: 60625943
 National Grid Reference: 482060, 411790
 Slice: A
 Site Area (Ha): 68.12
 Search Buffer (m): 100

Site Details

Keadby



Tel: 0844 844 9952
 Fax: 0844 844 9951
 Web: www.envirocheck.co.uk

Historical Mapping Legends

Ordnance Survey County Series and Ordnance Survey Plan 1:2,500

Quarry **Gravel Pit** **Sand Pit**
Clay Pit **Shingle** **Refuse Heap**
Sloping Masonry **Flat Rock**
Marsh **Reeds** **Osiers**
Rough Pasture **Furze** **Wood**
Mixed Wood **Brushwood** **Orchard**
Fir **Ford** **Stepping Stones**
Ferry **Waterfall** **Lock**
Trig. Station **Altitude at Trig. Station**
B.M. 325.9 **Bench Mark** **Surface Level**
Arrow denotes flow of water **Antiquities (site of)**
Cutting **Embankment**
Railway crossing Road **Level Crossing** **Road crossing Railway**
Railway crossing River or Canal **Road over single stream** **Road over River or Canal**
County Boundary (Geographical)
County & Civil Parish Boundary
Administrative County & Civil Parish Boundary
County Borough Boundary (England)
County Burgh Boundary (Scotland)
Co. Boro. Bdy.
Co. Burgh Bdy.
BP BS Boundary Post or Stone **P.C.B** Police Call Box
B.R. Bridle Road **P** Pump
E.P Electricity Pylon **S.P** Signal Post
F.B. Foot Bridge **Sl** Sluice
F.P. Foot Path **Sp.** Spring
G.P Guide Post or Board **T.C.B** Telephone Call Box
M.S Mile Stone **Tr.** Trough
M.P M.R Mooring Post or Ring **W** Well

Ordnance Survey Plan, Additional SIMs and Supply of Unpublished Survey Information 1:2,500 and 1:1,250

Inactive Quarry, Chalk Pit or Clay Pit **Active Quarry, Chalk Pit or Clay Pit**
Rock **Boulders**
Cliff **Slopes** **Top**
Roofed Building **Glazed Roof Building**
Sloping Masonry **Archway**
Non-Coniferous Tree (surveyed) **Coniferous Tree (surveyed)**
Non-Coniferous Trees (not surveyed) **Coniferous Trees (not surveyed)**
Orchard Tree **Scrub** **Bracken**
Coppice, Osier **Reeds** **Marsh, Saltings**
Rough Grassland **Heath** **Culvert**
Direction of water flow **Bench Mark** **Antiquity (site of)**
Cave Entrance **Triangulation Station** **Electricity Pylon**
Electricity Transmission Line
County Boundary (Geographical)
County & Civil Parish Boundary
Civil Parish Boundary
Admin. County or County Bor. Boundary
London Borough Boundary
Symbol marking point where boundary mereing changes
BH Beer House **P** Pillar, Pole or Post
BP, BS Boundary Post or Stone **PO** Post Office
Cn, C Capstan, Crane **PC** Public Convenience
Chy Chimney **PH** Public House
D Fn Drinking Fountain **Pp** Pump
EI P Electricity Pillar or Post **SB, S Br** Signal Box or Bridge
FAP Fire Alarm Pillar **SP, SL** Signal Post or Light
FB Foot Bridge **Spr** Spring
GP Guide Post **Tk** Tank or Track
H Hydrant or Hydraulic **TCB** Telephone Call Box
LC Level Crossing **TCP** Telephone Call Post
MH Manhole **Tr** Trough
MP Mile Post or Mooring Post **Wr Pt, Wr T** Water Point, Water Tap
MS Mile Stone **W** Well
NTL Normal Tidal Limit **Wd Pp** Wind Pump

Large-Scale National Grid Data 1:2,500 and 1:1,250

Cliff **Slopes** **Top**
Rock **Rock (scattered)**
Boulders **Boulders (scattered)**
Positioned Boulder **Scree**
Non-Coniferous Tree (surveyed) **Coniferous Tree (surveyed)**
Non-Coniferous Trees (not surveyed) **Coniferous Trees (not surveyed)**
Orchard Tree **Scrub** **Bracken**
Coppice, Osier **Reeds** **Marsh, Saltings**
Rough Grassland **Heath** **Culvert**
Direction of water flow **Triangulation Station** **Antiquity (site of)**
Electricity Transmission Line **Electricity Pylon**
B.M. 231.60m Bench Mark **Buildings with Building Seed**
Roofed Building **Glazed Roof Building**
Civil parish/community boundary
District boundary
County boundary
Boundary post/stone
Boundary mereing symbol (note: these always appear in opposed pairs or groups of three)
Bks Barracks **P** Pillar, Pole or Post
Bty Battery **PO** Post Office
Cemy Cemetery **PC** Public Convenience
Chy Chimney **Pp** Pump
Cis Cistern **Ppg Sta** Pumping Station
Dismtd Rly Dismantled Railway **PW** Place of Worship
EI Gen Sta Electricity Generating Station **Sewage Ppg Sta** Sewage Pumping Station
EI P Electricity Pole, Pillar **SB, S Br** Signal Box or Bridge
EI Sub Sta Electricity Sub Station **SP, SL** Signal Post or Light
FB Filter Bed **Spr** Spring
Fn / D Fn Fountain / Drinking Ftn. **Tk** Tank or Track
Gas Gov Gas Valve Compound **Tr** Trough
GVC Gas Governor **Wd Pp** Wind Pump
GP Guide Post **Wr Pt, Wr T** Water Point, Water Tap
MH Manhole **Wks** Works (building or area)
MP, MS Mile Post or Mile Stone **W** Well



Historical Mapping & Photography included:

Mapping Type	Scale	Date	Pg
Lincolnshire	1:2,500	1886 - 1887	2
Lincolnshire	1:2,500	1907	3
Ordnance Survey Plan	1:2,500	1966 - 1967	4
Additional SIMs	1:2,500	1966 - 1982	5
Additional SIMs	1:2,500	1991	6
Large-Scale National Grid Data	1:2,500	1994	7
Large-Scale National Grid Data	1:2,500	1995	8
Large-Scale National Grid Data	1:2,500	1995	9
Large-Scale National Grid Data	1:2,500	1996	10
Historical Aerial Photography	1:2,500	1999	11

Historical Map - Segment A11

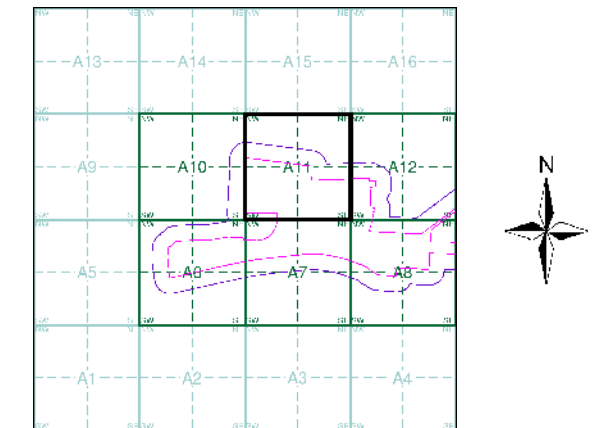

Order Details

Order Number: 242986885_1_1
 Customer Ref: 60625943
 National Grid Reference: 482060, 411790
 Slice: A
 Site Area (Ha): 68.12
 Search Buffer (m): 100

Site Details

Keaddy



Tel: 0844 844 9952
 Fax: 0844 844 9951
 Web: www.envirocheck.co.uk



Lincolnshire

Published 1886 - 1887

Source map scale - 1:2,500

The historical maps shown were reproduced from maps predominantly held at the scale adopted for England, Wales and Scotland in the 1840's. In 1854 the 1:2,500 scale was adopted for mapping urban areas and by 1896 it covered the whole of what were considered to be the cultivated parts of Great Britain. The published date given below is often some years later than the surveyed date. Before 1938, all OS maps were based on the Cassini Projection, with independent surveys of a single county or group of counties, giving rise to significant inaccuracies in outlying areas.

Map Name(s) and Date(s)

009_16 1886 1:2,500	010_13 1886 1:2,500
017_04 1886 1:2,500	018_01 1887 1:2,500

Historical Map - Segment A11

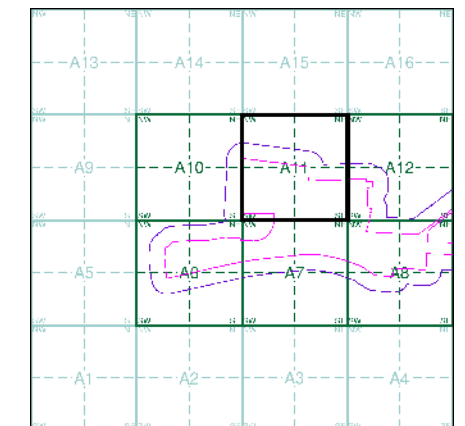

Order Details

Order Number: 242986885_1_1
 Customer Ref: 60625943
 National Grid Reference: 482060, 411790
 Slice: A
 Site Area (Ha): 68.12
 Search Buffer (m): 100

Site Details

Keadby



Tel: 0844 844 9952
 Fax: 0844 844 9951
 Web: www.envirocheck.co.uk

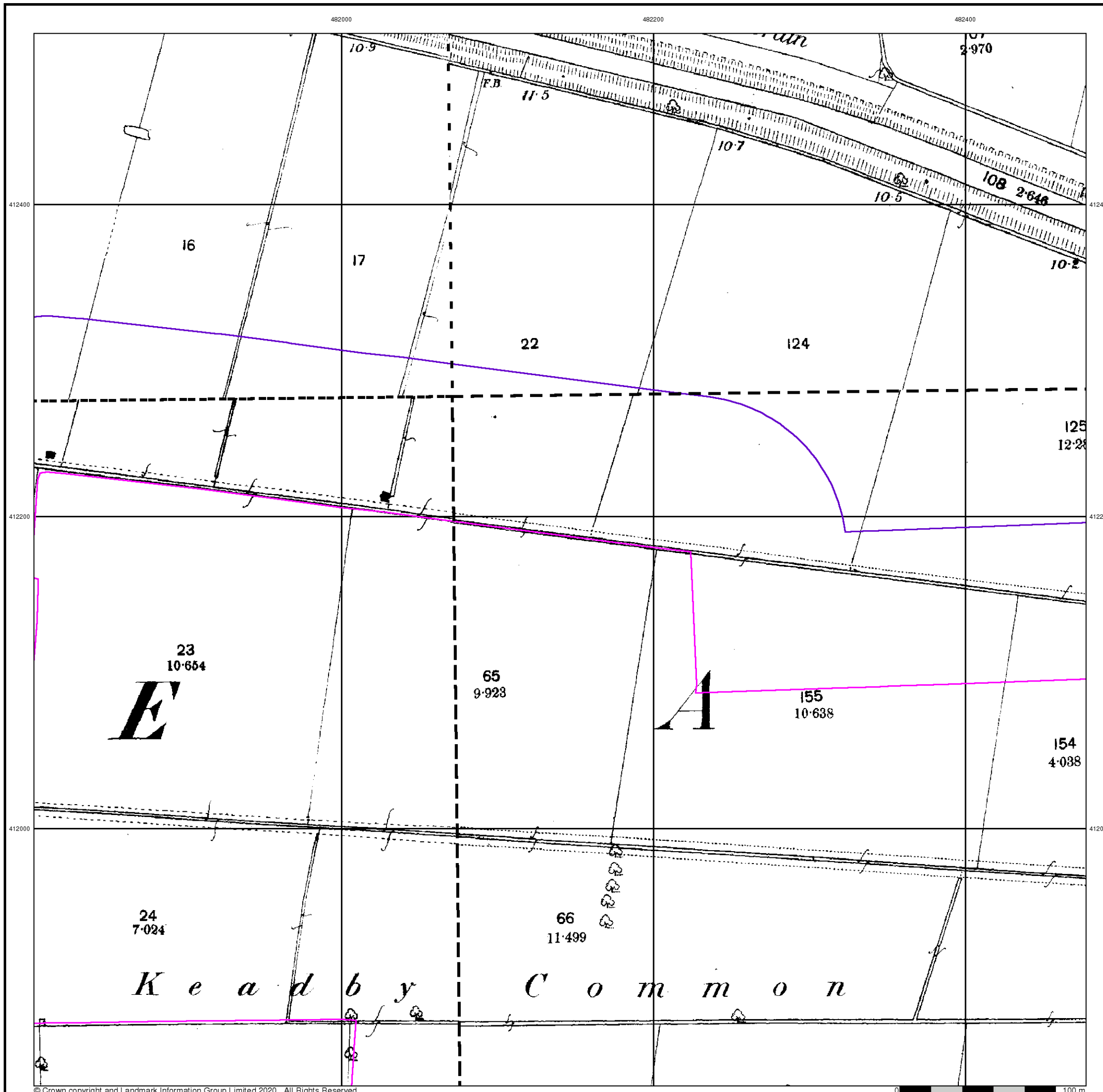



Lincolnshire

Published 1907

Source map scale - 1:2,500

The historical maps shown were reproduced from maps predominantly held at the scale adopted for England, Wales and Scotland in the 1840's. In 1854 the 1:2,500 scale was adopted for mapping urban areas and by 1896 it covered the whole of what were considered to be the cultivated parts of Great Britain. The published date given below is often some years later than the surveyed date. Before 1938, all OS maps were based on the Cassini Projection, with independent surveys of a single county or group of counties, giving rise to significant inaccuracies in outlying areas.

Map Name(s) and Date(s)

009_16 1907 1:2,500	010_13 1907 1:2,500
017_04 1907 1:2,500	018_01 1907 1:2,500

Historical Map - Segment A11

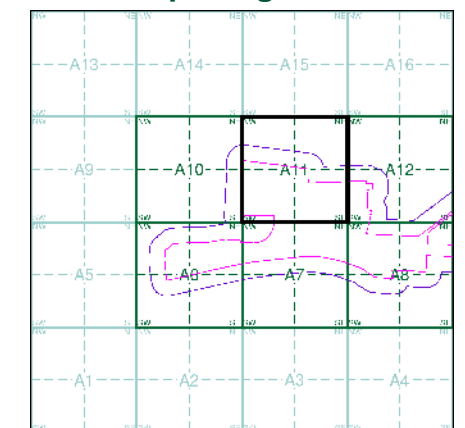

Order Details

Order Number: 242986885_1_1
 Customer Ref: 60625943
 National Grid Reference: 482060, 411790
 Slice: A
 Site Area (Ha): 68.12
 Search Buffer (m): 100

Site Details

Keadby



Tel: 0844 844 9952
 Fax: 0844 844 9951
 Web: www.envirocheck.co.uk

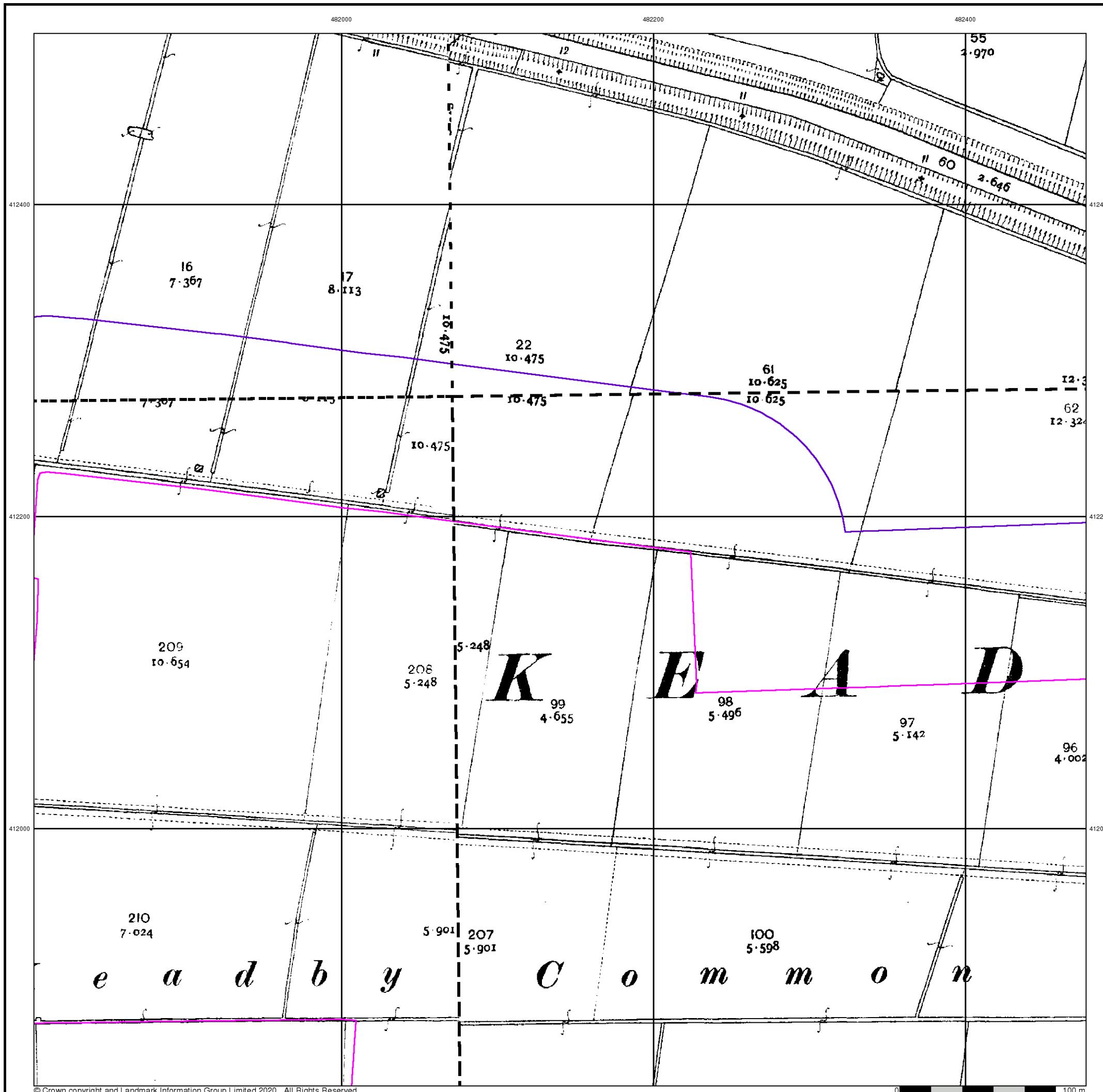



Ordnance Survey Plan

Published 1966 - 1967

Source map scale - 1:2,500

The historical maps shown were reproduced from maps predominantly held at the scale adopted for England, Wales and Scotland in the 1840's. In 1854 the 1:2,500 scale was adopted for mapping urban areas and by 1896 it covered the whole of what were considered to be the cultivated parts of Great Britain. The published date given below is often some years later than the surveyed date. Before 1938, all OS maps were based on the Cassini Projection, with independent surveys of a single county or group of counties, giving rise to significant inaccuracies in outlying areas.

Map Name(s) and Date(s)

SE8112 1966 1:2,500	SE8212 1966 1:2,500
SE8111 1967 1:2,500	SE8211 1967 1:2,500

Historical Map - Segment A11

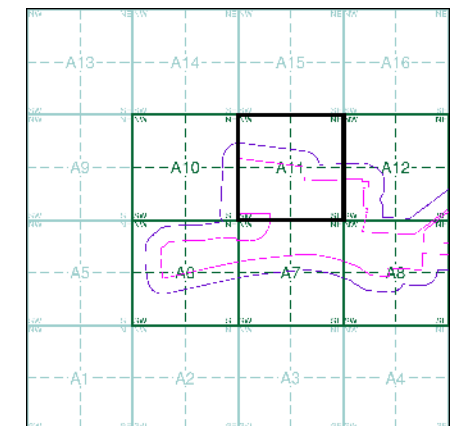

Order Details

Order Number: 242986885_1_1
 Customer Ref: 60625943
 National Grid Reference: 482060, 411790
 Slice: A
 Site Area (Ha): 68.12
 Search Buffer (m): 100

Site Details

Keadby



Tel: 0844 844 9952
 Fax: 0844 844 9951
 Web: www.envirocheck.co.uk

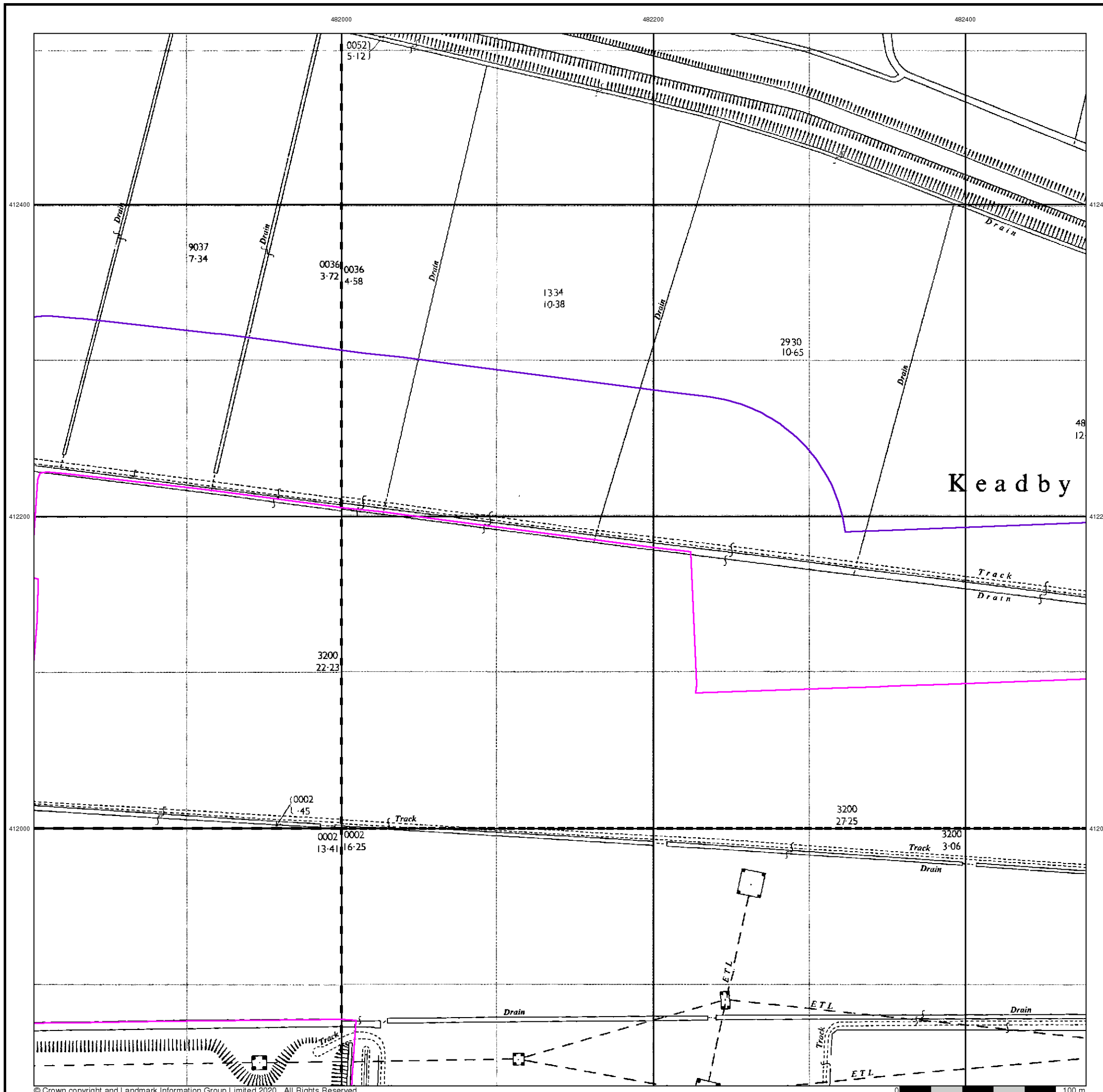



Additional SIMs

Published 1966 - 1982

Source map scale - 1:2,500

The SIM cards (Ordnance Survey's 'Survey of Information on Microfilm') are further, minor editions of mapping which were produced and published in between the main editions as an area was updated. They date from 1947 to 1994, and contain detailed information on buildings, roads and land-use. These maps were produced at both 1:2,500 and 1:1,250 scales.

Map Name(s) and Date(s)

SE8112 1966 12,500	SE8212 1982 12,500
SE8111 1967 12,500	SE8211 1978 12,500

Historical Map - Segment A11

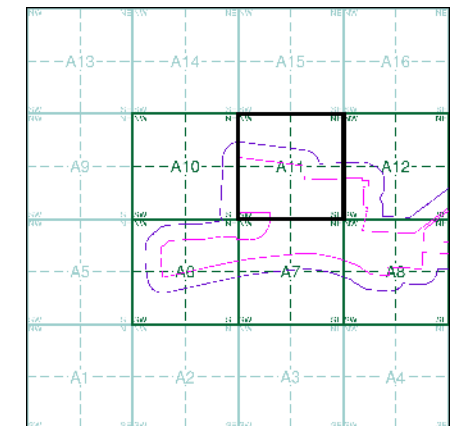

Order Details

Order Number: 242986885_1_1
 Customer Ref: 60625943
 National Grid Reference: 482060, 411790
 Slice: A
 Site Area (Ha): 68.12
 Search Buffer (m): 100

Site Details

Keadby



Tel: 0844 844 9952
 Fax: 0844 844 9951
 Web: www.envirocheck.co.uk

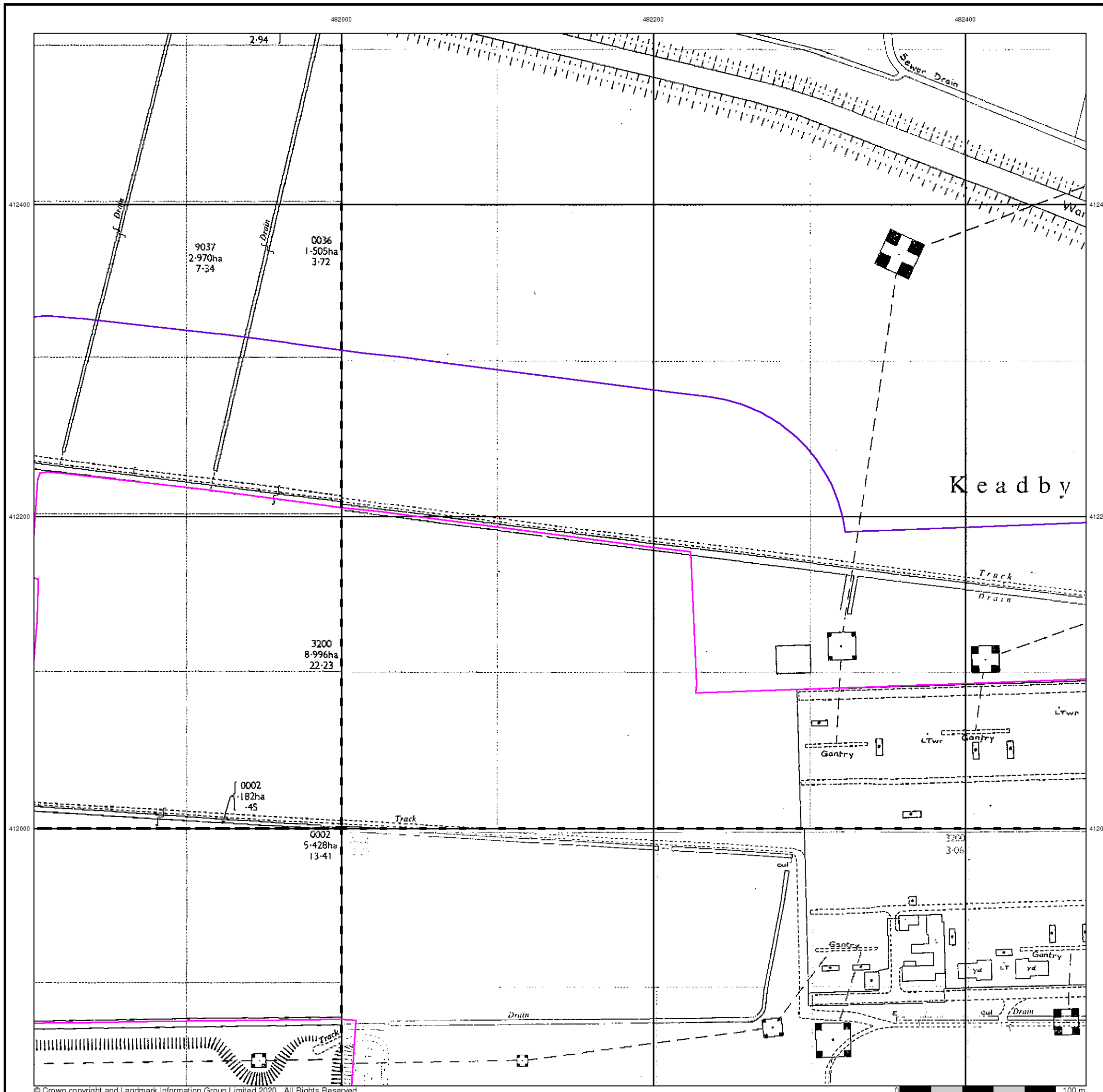

482000

482200

482400



Additional SIMs

Published 1991

Source map scale - 1:2,500

The SIM cards (Ordnance Survey's 'Survey of Information on Microfilm') are further, minor editions of mapping which were produced and published in between the main editions as an area was updated. They date from 1947 to 1994, and contain detailed information on buildings, roads and land-use. These maps were produced at both 1:2,500 and 1:1,250 scales.

Map Name(s) and Date(s)

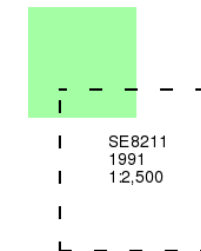

Historical Map - Segment A11

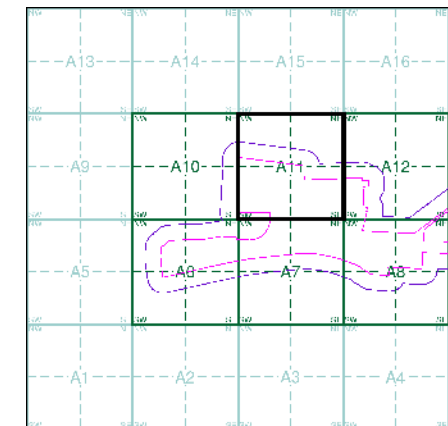

Order Details

Order Number: 242986885_1_1
 Customer Ref: 60625943
 National Grid Reference: 482060, 411790
 Slice: A
 Site Area (Ha): 68.12
 Search Buffer (m): 100

Site Details

Keadby



Tel: 0844 844 9952
 Fax: 0844 844 9951
 Web: www.envirocheck.co.uk

412400

412400

412200

412200

412000

412000

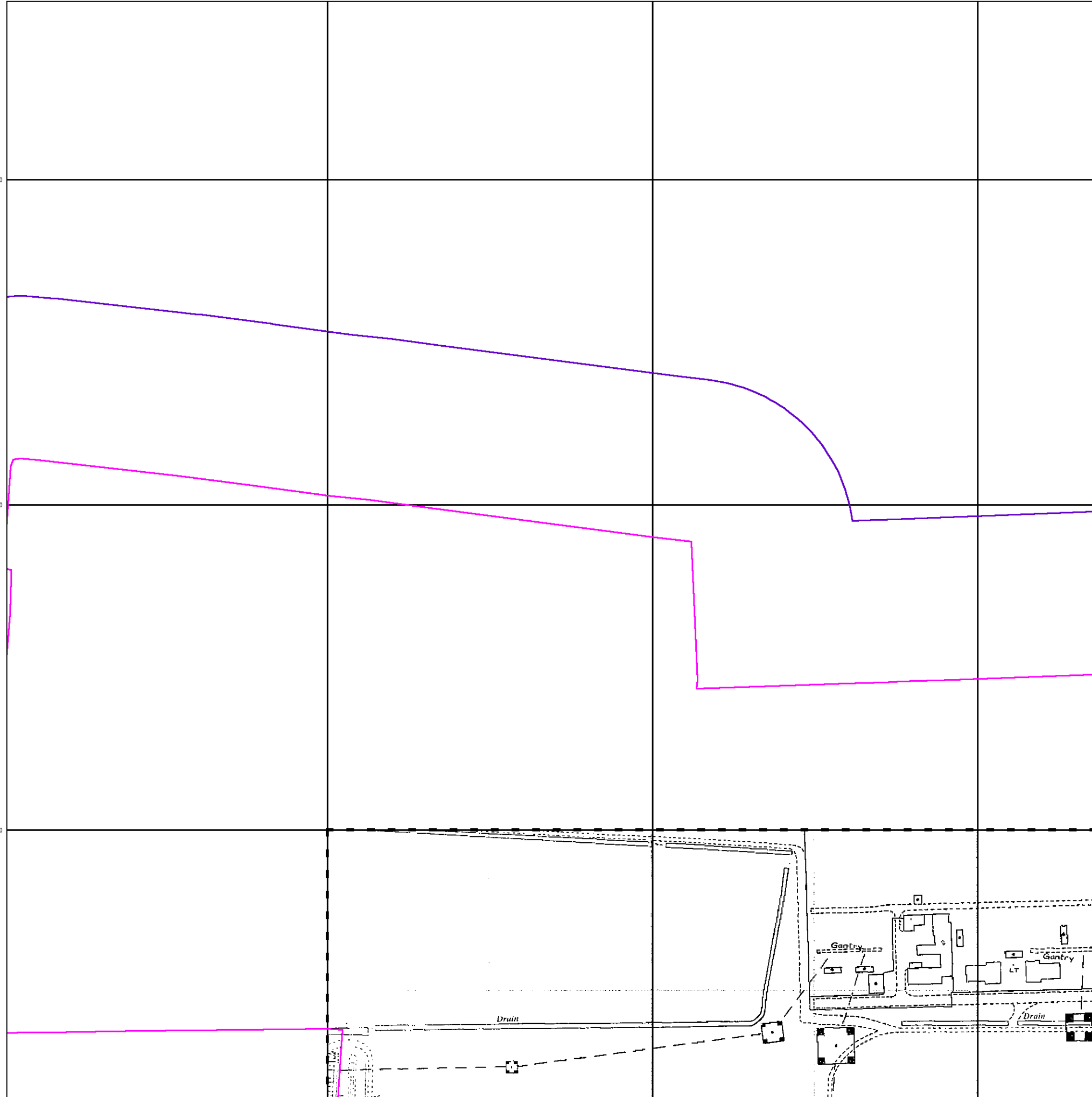



Large-Scale National Grid Data

Published 1994

Source map scale - 1:2,500

'Large Scale National Grid Data' superseded SIM cards (Ordnance Survey's 'Survey of Information on Microfilm') in 1992, and continued to be produced until 1999. These maps were the fore-runners of digital mapping and so provide detailed information on houses and roads, but tend to show less topographic features such as vegetation. These maps were produced at both 1:2,500 and 1:1,250 scales.

Map Name(s) and Date(s)

SE8112 1994 1:2,500	SE8212 1994 1:2,500
SE8111 1994 1:2,500	SE8211 1994 1:2,500

Historical Map - Segment A11

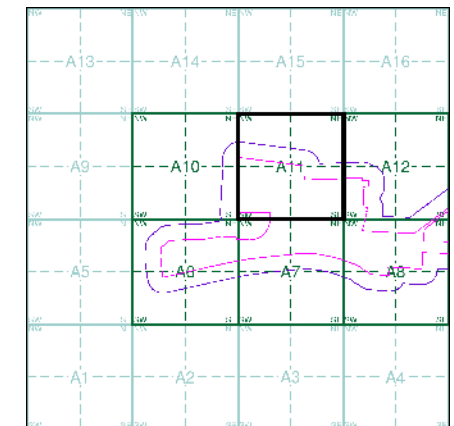

Order Details

Order Number: 242986885_1_1
 Customer Ref: 60625943
 National Grid Reference: 482060, 411790
 Slice: A
 Site Area (Ha): 68.12
 Search Buffer (m): 100

Site Details

Keadby



Tel: 0844 844 9952
 Fax: 0844 844 9951
 Web: www.envirocheck.co.uk

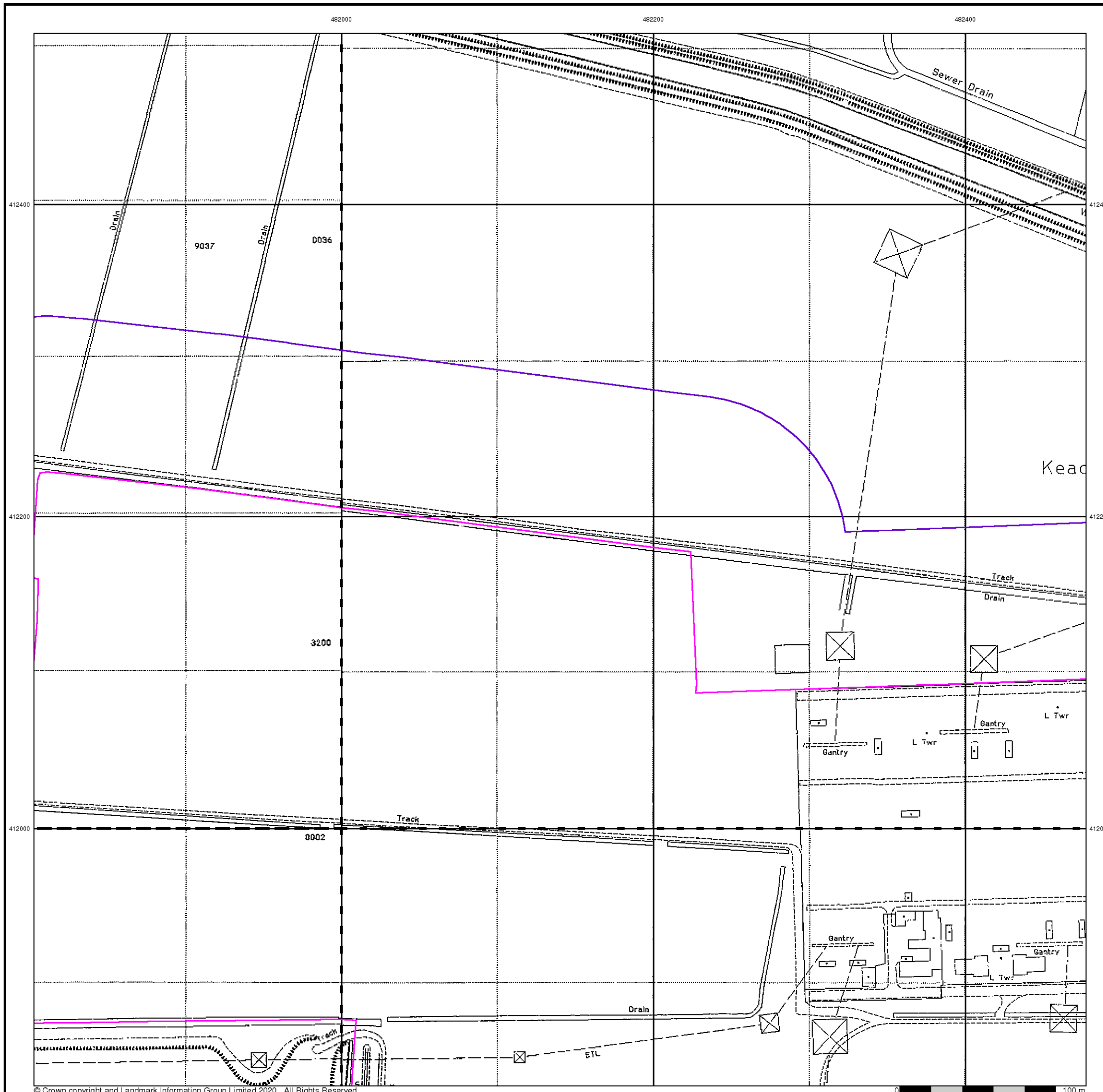



Large-Scale National Grid Data

Published 1995

Source map scale - 1:2,500

'Large Scale National Grid Data' superseded SIM cards (Ordnance Survey's 'Survey of Information on Microfilm') in 1992, and continued to be produced until 1999. These maps were the fore-runners of digital mapping and so provide detailed information on houses and roads, but tend to show less topographic features such as vegetation. These maps were produced at both 1:2,500 and 1:1,250 scales.

Map Name(s) and Date(s)

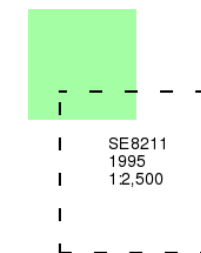

Historical Map - Segment A11

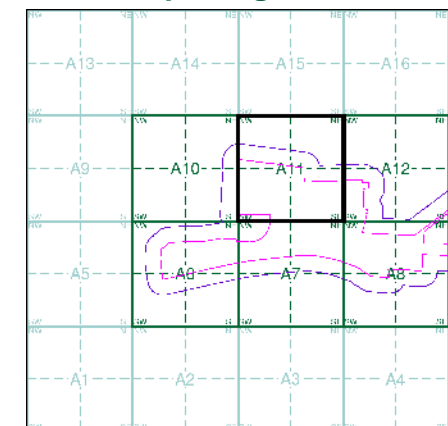

Order Details

Order Number: 242986885_1_1
Customer Ref: 60625943
National Grid Reference: 482060, 411790
Slice: A
Site Area (Ha): 68.12
Search Buffer (m): 100

Site Details

Keadby



Tel: 0844 844 9952
Fax: 0844 844 9951
Web: www.envirocheck.co.uk

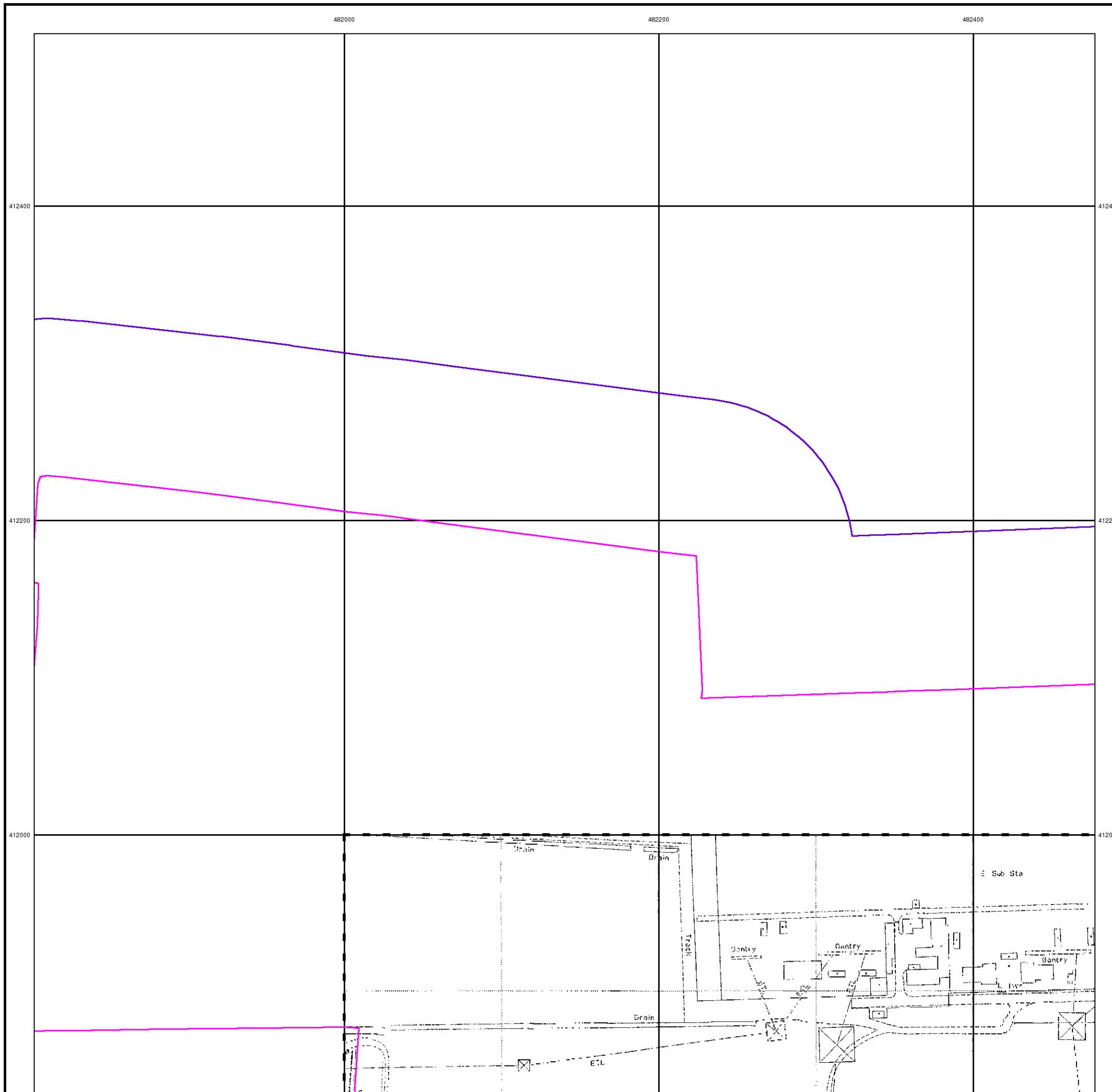



Large-Scale National Grid Data

Published 1996

Source map scale - 1:2,500

'Large Scale National Grid Data' superseded SIM cards (Ordnance Survey's 'Survey of Information on Microfilm') in 1992, and continued to be produced until 1999. These maps were the fore-runners of digital mapping and so provide detailed information on houses and roads, but tend to show less topographic features such as vegetation. These maps were produced at both 1:2,500 and 1:1,250 scales.

Map Name(s) and Date(s)

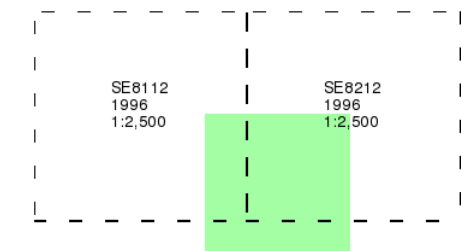

Historical Map - Segment A11

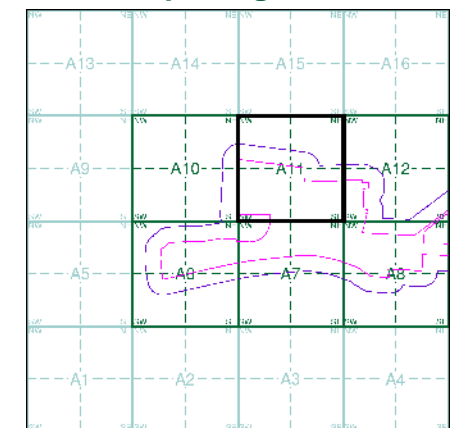

Order Details

Order Number: 242986885_1_1
 Customer Ref: 60625943
 National Grid Reference: 482060, 411790
 Slice: A
 Site Area (Ha): 68.12
 Search Buffer (m): 100

Site Details

Keadby



Tel: 0844 844 9952
 Fax: 0844 844 9951
 Web: www.envirocheck.co.uk

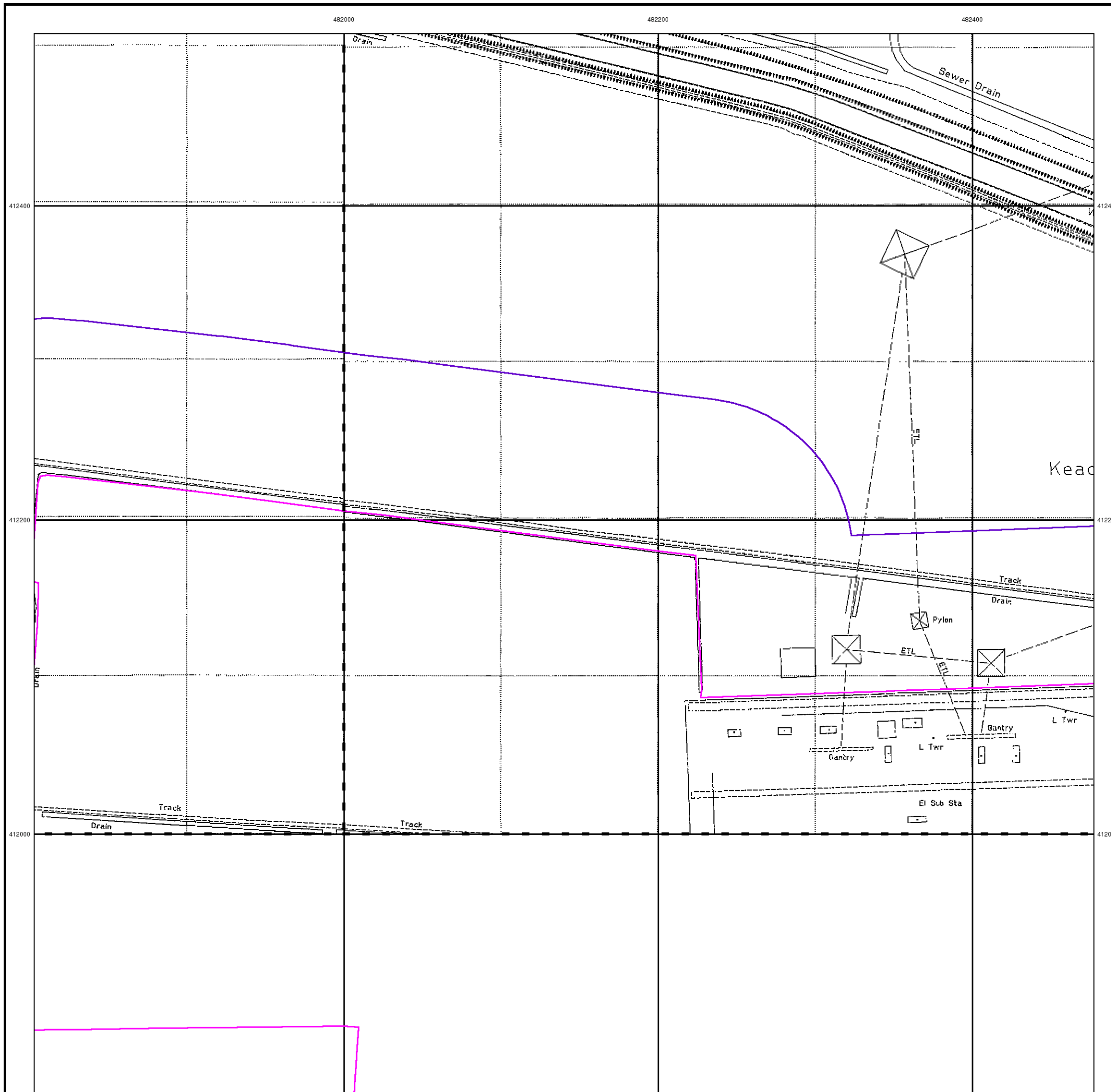

482000

482200

482400



Historical Aerial Photography

Published 1999

This aerial photography was produced by Getmapping, these vertical aerial photographs provide a seamless, full colour survey of the whole of Great Britain

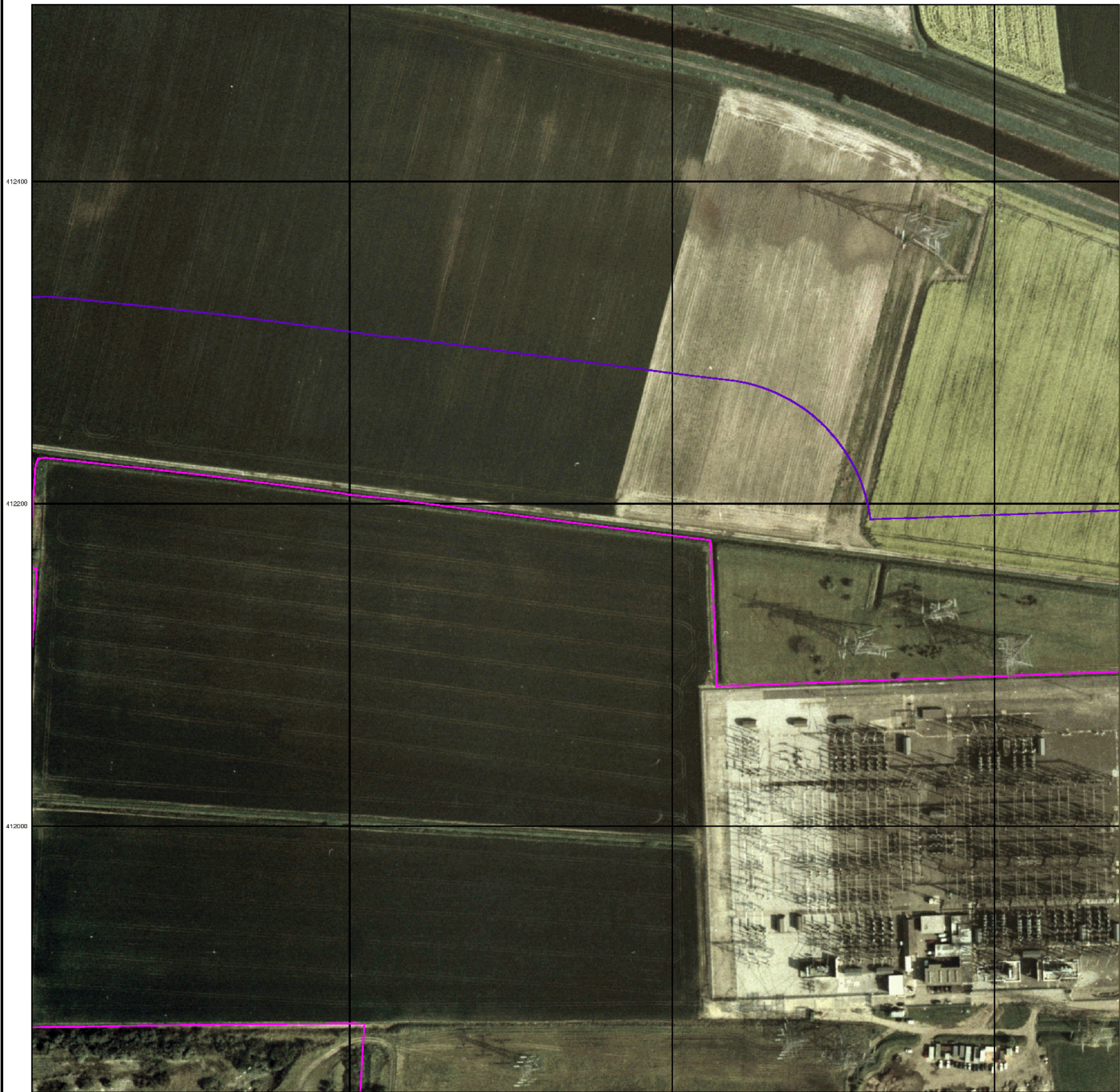

412400

412400

412200

412200

412000

412000

Historical Aerial Photography - Segment A11

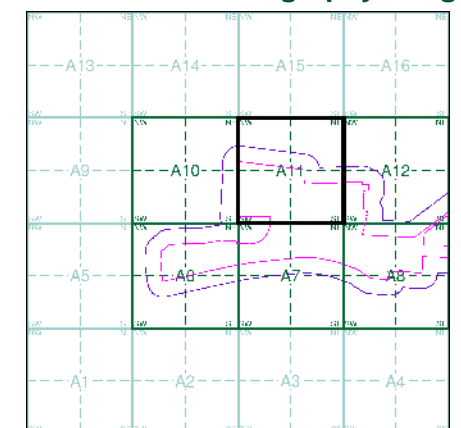

Order Details

Order Number: 242986885_1_1
 Customer Ref: 60625943
 National Grid Reference: 482060, 411790
 Slice: A
 Site Area (Ha): 68.12
 Search Buffer (m): 100

Site Details

Keadby



Tel: 0844 844 9952
 Fax: 0844 844 9951
 Web: www.envirocheck.co.uk

Historical Mapping Legends

Ordnance Survey County Series and Ordnance Survey Plan 1:2,500

Quarry **Gravel Pit** **Sand Pit**
Clay Pit **Shingle** **Refuse Heap**
Sloping Masonry **Flat Rock**
Marsh **Reeds** **Osiers**
Rough Pasture **Furze** **Wood**
Mixed Wood **Brushwood** **Orchard**
Fir **Ford** **Stepping Stones**
Ferry **Waterfall** **Lock**
Trig. Station **Altitude at Trig. Station**
B.M. 325.9 **Bench Mark** **Surface Level**
Arrow denotes flow of water **Antiquities (site of)**
Cutting **Embankment**
Railway crossing Road **Level Crossing** **Road crossing Railway**
Railway crossing River or Canal **Road over single stream** **Road over River or Canal**
County Boundary (Geographical)
County & Civil Parish Boundary
Administrative County & Civil Parish Boundary
County Borough Boundary (England)
County Burgh Boundary (Scotland)
Co. Boro. Bdy.
Co. Burgh Bdy.
BP BS Boundary Post or Stone **P.C.B** Police Call Box
B.R. Bridle Road **P** Pump
E.P Electricity Pylon **S.P** Signal Post
F.B. Foot Bridge **Sl** Sluice
F.P. Foot Path **Sp.** Spring
G.P Guide Post or Board **T.C.B** Telephone Call Box
M.S Mile Stone **Tr.** Trough
M.P M.R Mooring Post or Ring **W** Well

Ordnance Survey Plan, Additional SIMs and Supply of Unpublished Survey Information 1:2,500 and 1:1,250

Inactive Quarry, Chalk Pit or Clay Pit **Active Quarry, Chalk Pit or Clay Pit**
Rock **Boulders**
Cliff **Slopes** **Top**
Roofed Building **Glazed Roof Building**
Sloping Masonry **Archway**
Non-Coniferous Tree (surveyed) **Coniferous Tree (surveyed)**
Non-Coniferous Trees (not surveyed) **Coniferous Trees (not surveyed)**
Orchard Tree **Scrub** **Bracken**
Coppice, Osier **Reeds** **Marsh, Saltings**
Rough Grassland **Heath** **Culvert**
Direction of water flow **Bench Mark** **Antiquity (site of)**
Cave Entrance **Triangulation Station** **Electricity Pylon**
Electricity Transmission Line
County Boundary (Geographical)
County & Civil Parish Boundary
Civil Parish Boundary
Admin. County or County Bor. Boundary
London Borough Boundary
Symbol marking point where boundary mereing changes
BH Beer House **P** Pillar, Pole or Post
BP, BS Boundary Post or Stone **PO** Post Office
Cn, C Capstan, Crane **PC** Public Convenience
Chy Chimney **PH** Public House
D Fn Drinking Fountain **Pp** Pump
EI P Electricity Pillar or Post **SB, S Br** Signal Box or Bridge
FAP Fire Alarm Pillar **SP, SL** Signal Post or Light
FB Foot Bridge **Spr** Spring
GP Guide Post **Tk** Tank or Track
H Hydrant or Hydraulic **TCB** Telephone Call Box
LC Level Crossing **TCP** Telephone Call Post
MH Manhole **Tr** Trough
MP Mile Post or Mooring Post **Wr Pt, Wr T** Water Point, Water Tap
MS Mile Stone **W** Well
NTL Normal Tidal Limit **Wd Pp** Wind Pump

Large-Scale National Grid Data 1:2,500 and 1:1,250

Cliff **Slopes** **Top**
Rock **Rock (scattered)**
Boulders **Boulders (scattered)**
Positioned Boulder **Scree**
Non-Coniferous Tree (surveyed) **Coniferous Tree (surveyed)**
Non-Coniferous Trees (not surveyed) **Coniferous Trees (not surveyed)**
Orchard Tree **Scrub** **Bracken**
Coppice, Osier **Reeds** **Marsh, Saltings**
Rough Grassland **Heath** **Culvert**
Direction of water flow **Triangulation Station** **Antiquity (site of)**
Electricity Transmission Line **Electricity Pylon**
B.M. 231.60m Bench Mark **Buildings with Building Seed**
Roofed Building **Glazed Roof Building**
Civil parish/community boundary
District boundary
County boundary
Boundary post/stone
Boundary mereing symbol (note: these always appear in opposed pairs or groups of three)
Bks Barracks **P** Pillar, Pole or Post
Bty Battery **PO** Post Office
Cemy Cemetery **PC** Public Convenience
Chy Chimney **Pp** Pump
Cis Cistern **Ppg Sta** Pumping Station
Dismtd Rly Dismantled Railway **PW** Place of Worship
EI Gen Sta Electricity Generating Station **Sewage Ppg Sta** Sewage Pumping Station
EI P Electricity Pole, Pillar **SB, S Br** Signal Box or Bridge
EI Sub Sta Electricity Sub Station **SP, SL** Signal Post or Light
FB Filter Bed **Spr** Spring
Fn / D Fn Fountain / Drinking Ftn. **Tk** Tank or Track
Gas Gov Gas Valve Compound **Tr** Trough
GVC Gas Governor **Wd Pp** Wind Pump
GP Guide Post **Wr Pt, Wr T** Water Point, Water Tap
MH Manhole **Wks** Works (building or area)
MP, MS Mile Post or Mile Stone **W** Well



Historical Mapping & Photography included:

Mapping Type	Scale	Date	Pg
Lincolnshire	1:2,500	1886 - 1887	2
Lincolnshire	1:2,500	1907	3
Ordnance Survey Plan	1:2,500	1966 - 1967	4
Additional SIMs	1:2,500	1978 - 1982	5
Additional SIMs	1:2,500	1991	6
Large-Scale National Grid Data	1:2,500	1994	7
Large-Scale National Grid Data	1:2,500	1995	8
Large-Scale National Grid Data	1:2,500	1995	9
Large-Scale National Grid Data	1:2,500	1996	10
Large-Scale National Grid Data	1:2,500	1996	11
Historical Aerial Photography	1:2,500	1999	12

Historical Map - Segment A12

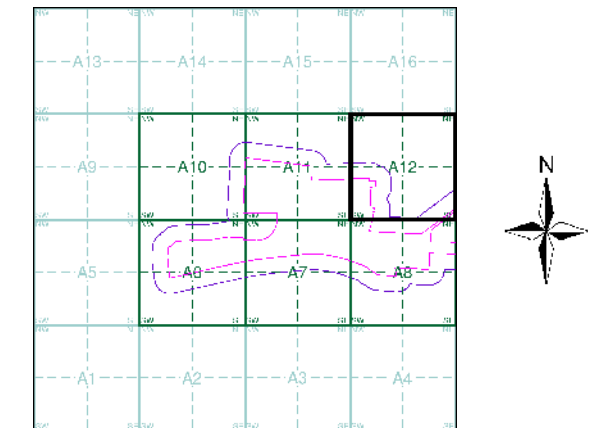

Order Details

Order Number: 242986885_1_1
 Customer Ref: 60625943
 National Grid Reference: 482060, 411790
 Slice: A
 Site Area (Ha): 68.12
 Search Buffer (m): 100

Site Details

Keaddy



Tel: 0844 844 9952
 Fax: 0844 844 9951
 Web: www.envirocheck.co.uk



Lincolnshire

Published 1886 - 1887

Source map scale - 1:2,500

The historical maps shown were reproduced from maps predominantly held at the scale adopted for England, Wales and Scotland in the 1840's. In 1854 the 1:2,500 scale was adopted for mapping urban areas and by 1896 it covered the whole of what were considered to be the cultivated parts of Great Britain. The published date given below is often some years later than the surveyed date. Before 1938, all OS maps were based on the Cassini Projection, with independent surveys of a single county or group of counties, giving rise to significant inaccuracies in outlying areas.

Map Name(s) and Date(s)

010_13
1886
1:2,500
018_01
1887
1:2,500

Historical Map - Segment A12

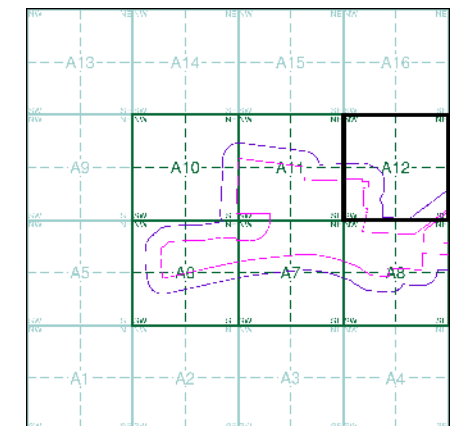

Order Details

Order Number: 242986885_1_1
Customer Ref: 60625943
National Grid Reference: 482060, 411790
Slice: A
Site Area (Ha): 68.12
Search Buffer (m): 100

Site Details

Keadby



Tel: 0844 844 9952
Fax: 0844 844 9951
Web: www.envirocheck.co.uk

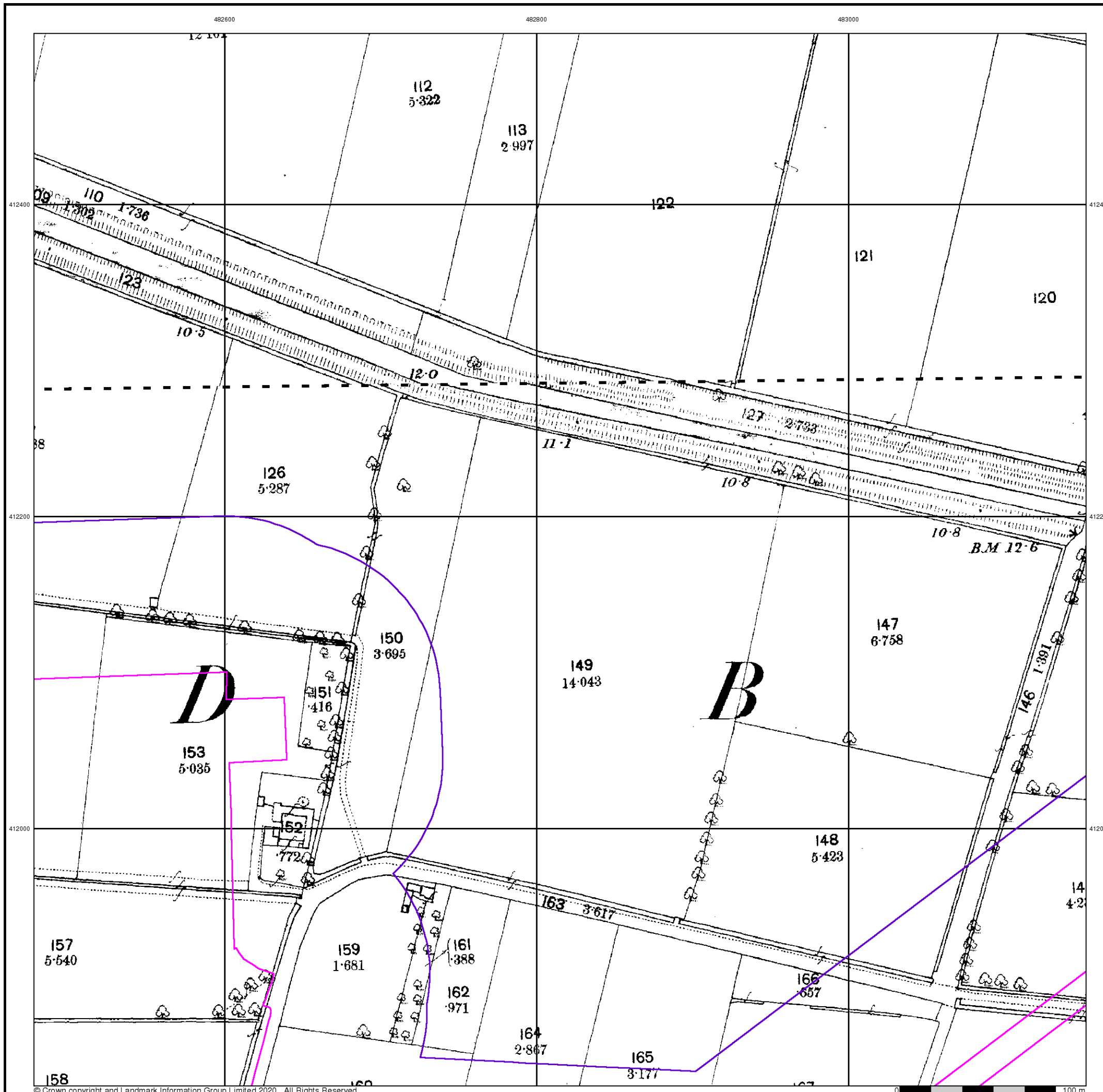



Lincolnshire

Published 1907

Source map scale - 1:2,500

The historical maps shown were reproduced from maps predominantly held at the scale adopted for England, Wales and Scotland in the 1840's. In 1854 the 1:2,500 scale was adopted for mapping urban areas and by 1896 it covered the whole of what were considered to be the cultivated parts of Great Britain. The published date given below is often some years later than the surveyed date. Before 1938, all OS maps were based on the Cassini Projection, with independent surveys of a single county or group of counties, giving rise to significant inaccuracies in outlying areas.

Map Name(s) and Date(s)

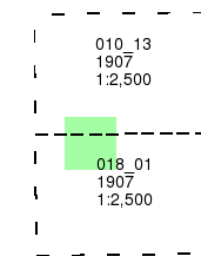

Historical Map - Segment A12

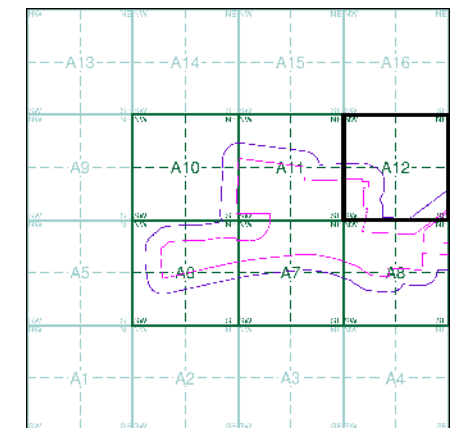

Order Details

Order Number: 242986885_1_1
Customer Ref: 60625943
National Grid Reference: 482060, 411790
Slice: A
Site Area (Ha): 68.12
Search Buffer (m): 100

Site Details

Keadby



Tel: 0844 844 9952
Fax: 0844 844 9951
Web: www.envirocheck.co.uk

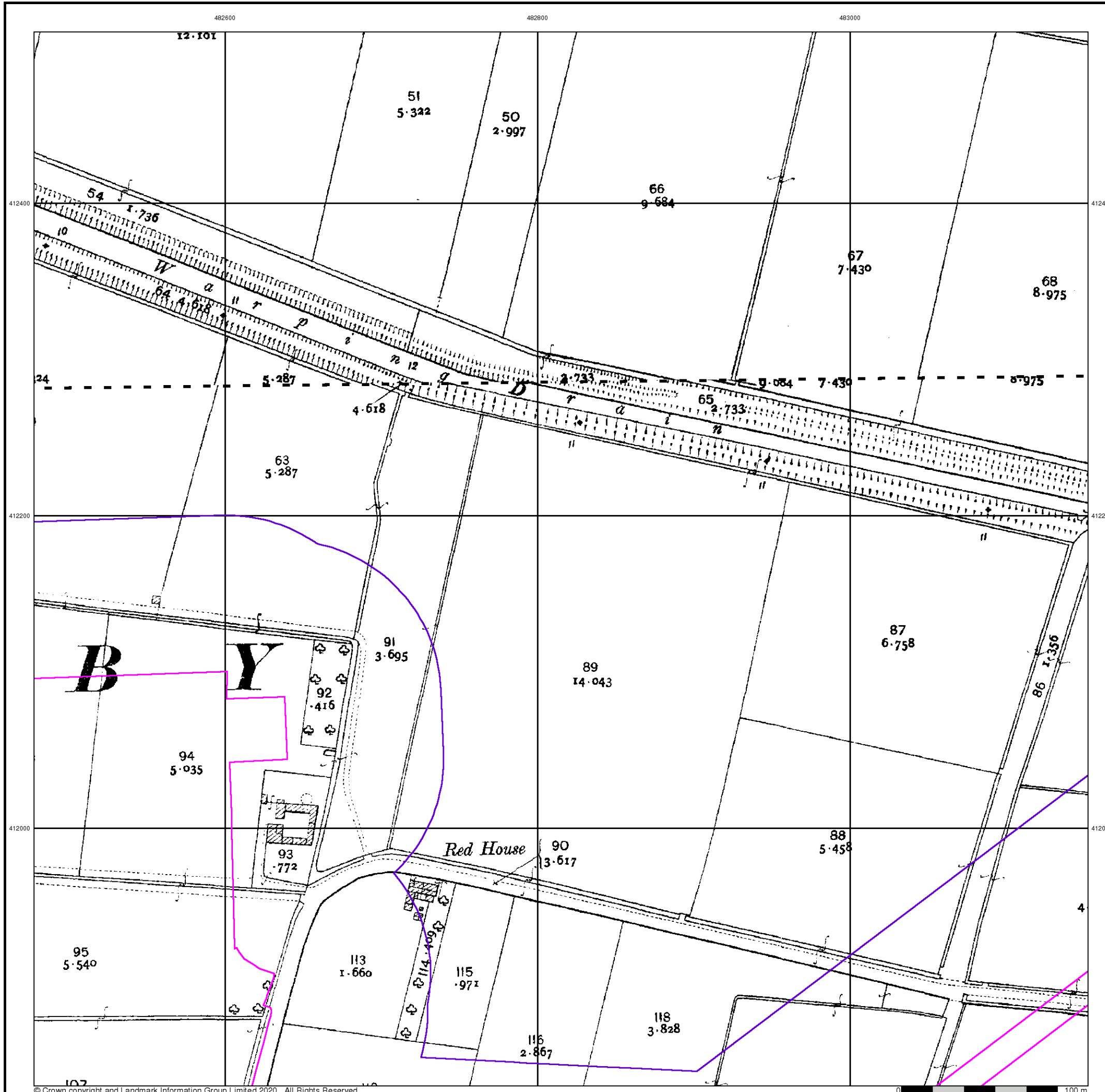



Ordnance Survey Plan

Published 1966 - 1967

Source map scale - 1:2,500

The historical maps shown were reproduced from maps predominantly held at the scale adopted for England, Wales and Scotland in the 1840's. In 1854 the 1:2,500 scale was adopted for mapping urban areas and by 1896 it covered the whole of what were considered to be the cultivated parts of Great Britain. The published date given below is often some years later than the surveyed date. Before 1938, all OS maps were based on the Cassini Projection, with independent surveys of a single county or group of counties, giving rise to significant inaccuracies in outlying areas.

Map Name(s) and Date(s)

SE8212 1966 1:2,500	SE8312 1966 1:2,500
SE8211 1967 1:2,500	SE8311 1967 1:2,500

Historical Map - Segment A12

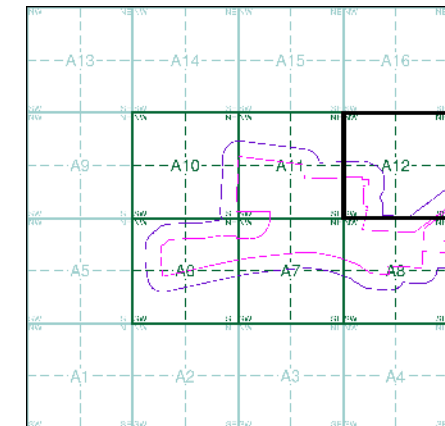

Order Details

Order Number: 242986885_1_1
Customer Ref: 60625943
National Grid Reference: 482060, 411790
Slice: A
Site Area (Ha): 68.12
Search Buffer (m): 100

Site Details

Keadby



Tel: 0844 844 9952
Fax: 0844 844 9951
Web: www.envirocheck.co.uk

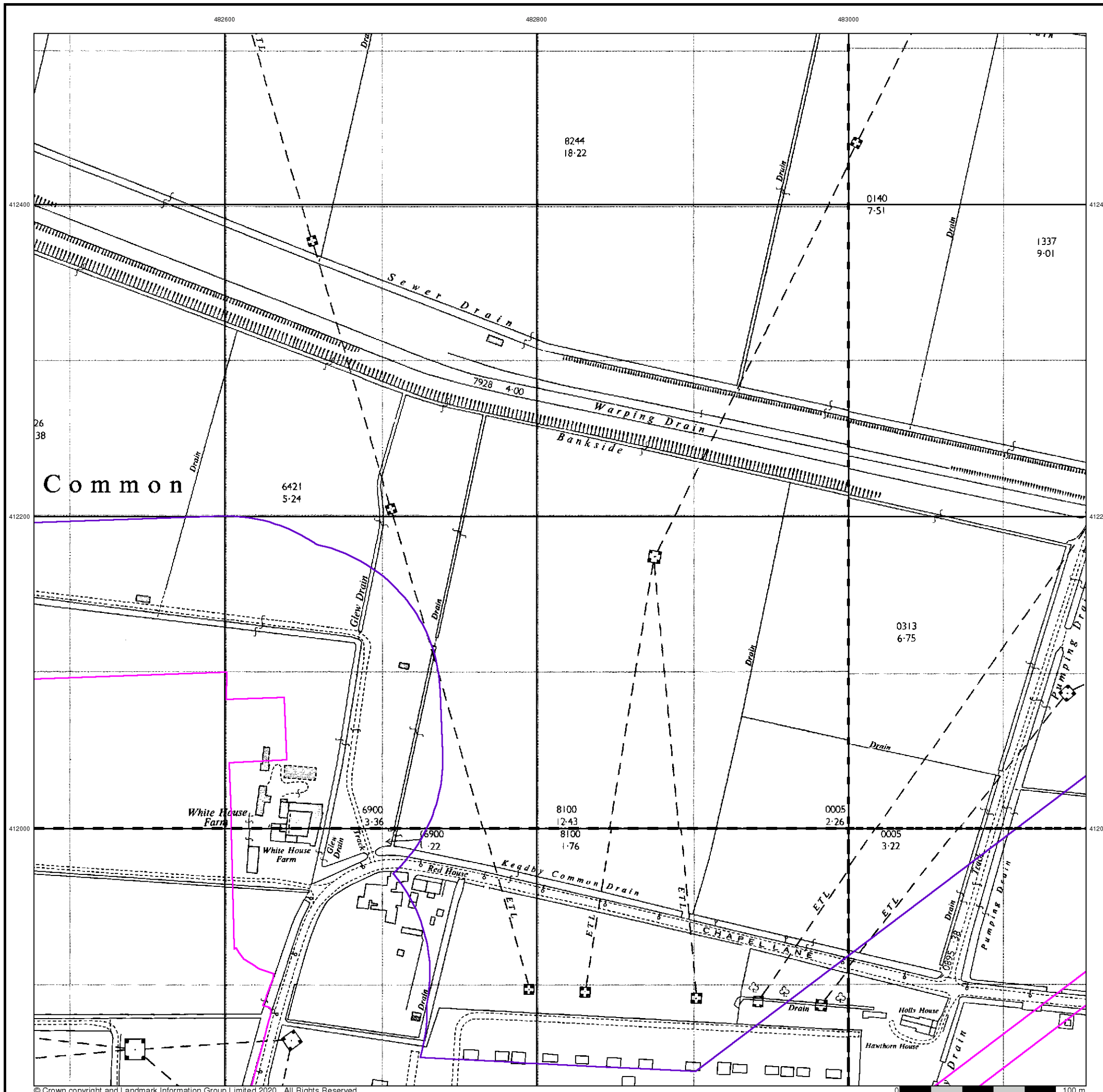



Additional SIMs

Published 1978 - 1982

Source map scale - 1:2,500

The SIM cards (Ordnance Survey's 'Survey of Information on Microfilm') are further, minor editions of mapping which were produced and published in between the main editions as an area was updated. They date from 1947 to 1994, and contain detailed information on buildings, roads and land-use. These maps were produced at both 1:2,500 and 1:1,250 scales.

Map Name(s) and Date(s)

SE8212 1982 12,500	SE8312 1982 12,500
SE8211 1978 12,500	SE8311 1982 12,500

Historical Map - Segment A12

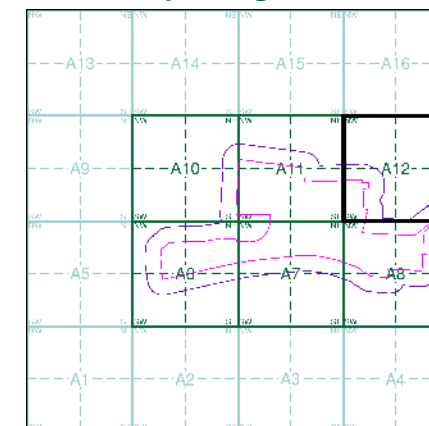

Order Details

Order Number: 242986885_1_1
 Customer Ref: 60625943
 National Grid Reference: 482060, 411790
 Slice: A
 Site Area (Ha): 68.12
 Search Buffer (m): 100

Site Details

Keadby



Tel: 0844 844 9952
 Fax: 0844 844 9951
 Web: www.envirocheck.co.uk

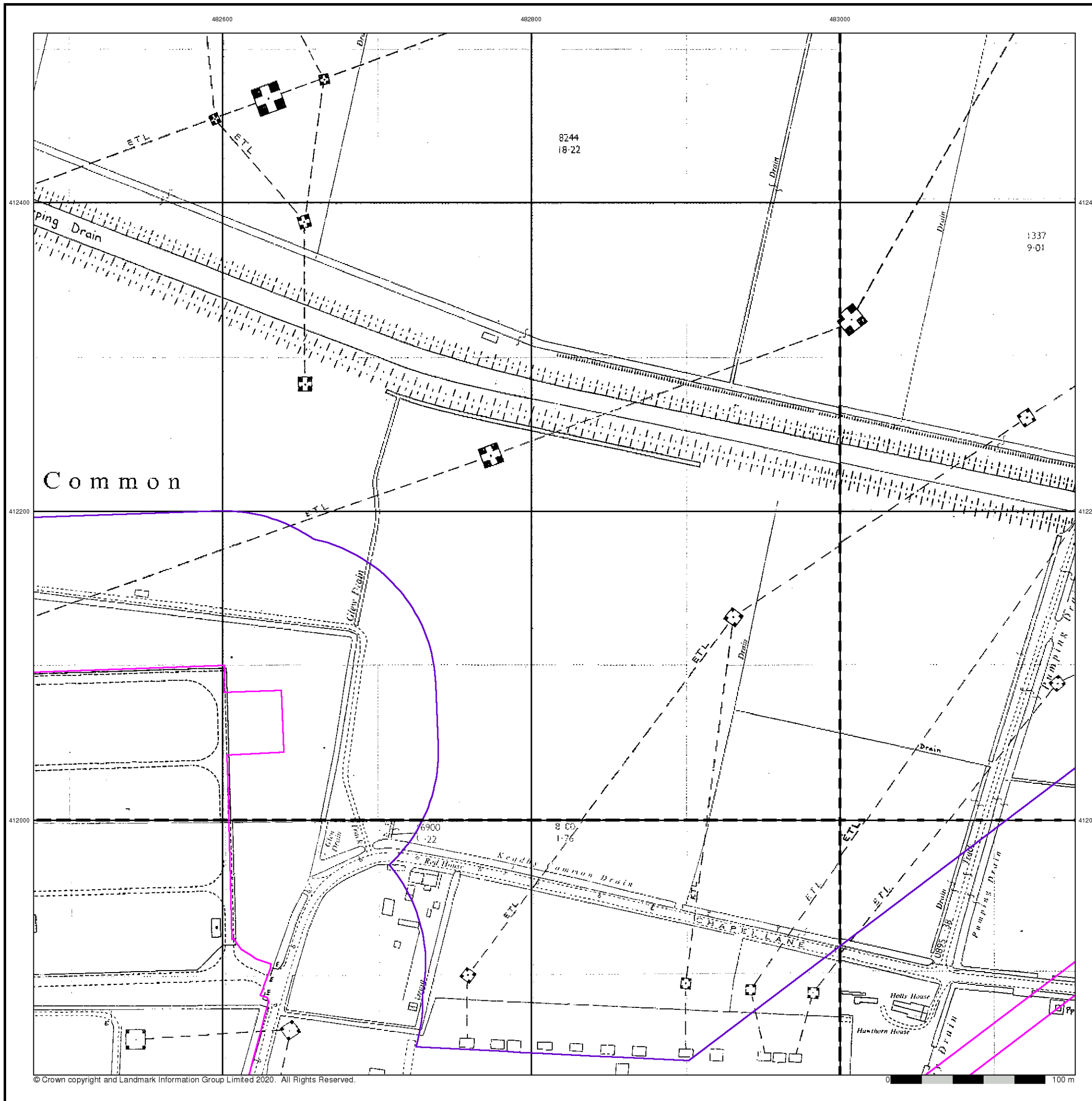

482600

482800

483000

412400

412400

412200

412200

412000

412000



Additional SIMs

Published 1991

Source map scale - 1:2,500

The SIM cards (Ordnance Survey's 'Survey of Information on Microfilm') are further, minor editions of mapping which were produced and published in between the main editions as an area was updated. They date from 1947 to 1994, and contain detailed information on buildings, roads and land-use. These maps were produced at both 1:2,500 and 1:1,250 scales.

Map Name(s) and Date(s)

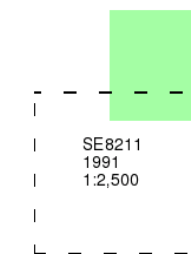

Historical Map - Segment A12

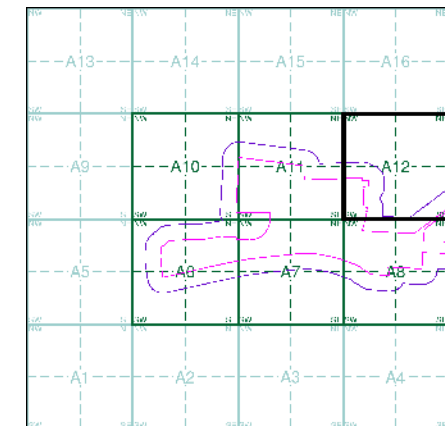

Order Details

Order Number: 242986885_1_1
 Customer Ref: 60625943
 National Grid Reference: 482060, 411790
 Slice: A
 Site Area (Ha): 68.12
 Search Buffer (m): 100

Site Details

Keadby



Tel: 0844 844 9952
 Fax: 0844 844 9951
 Web: www.envirocheck.co.uk

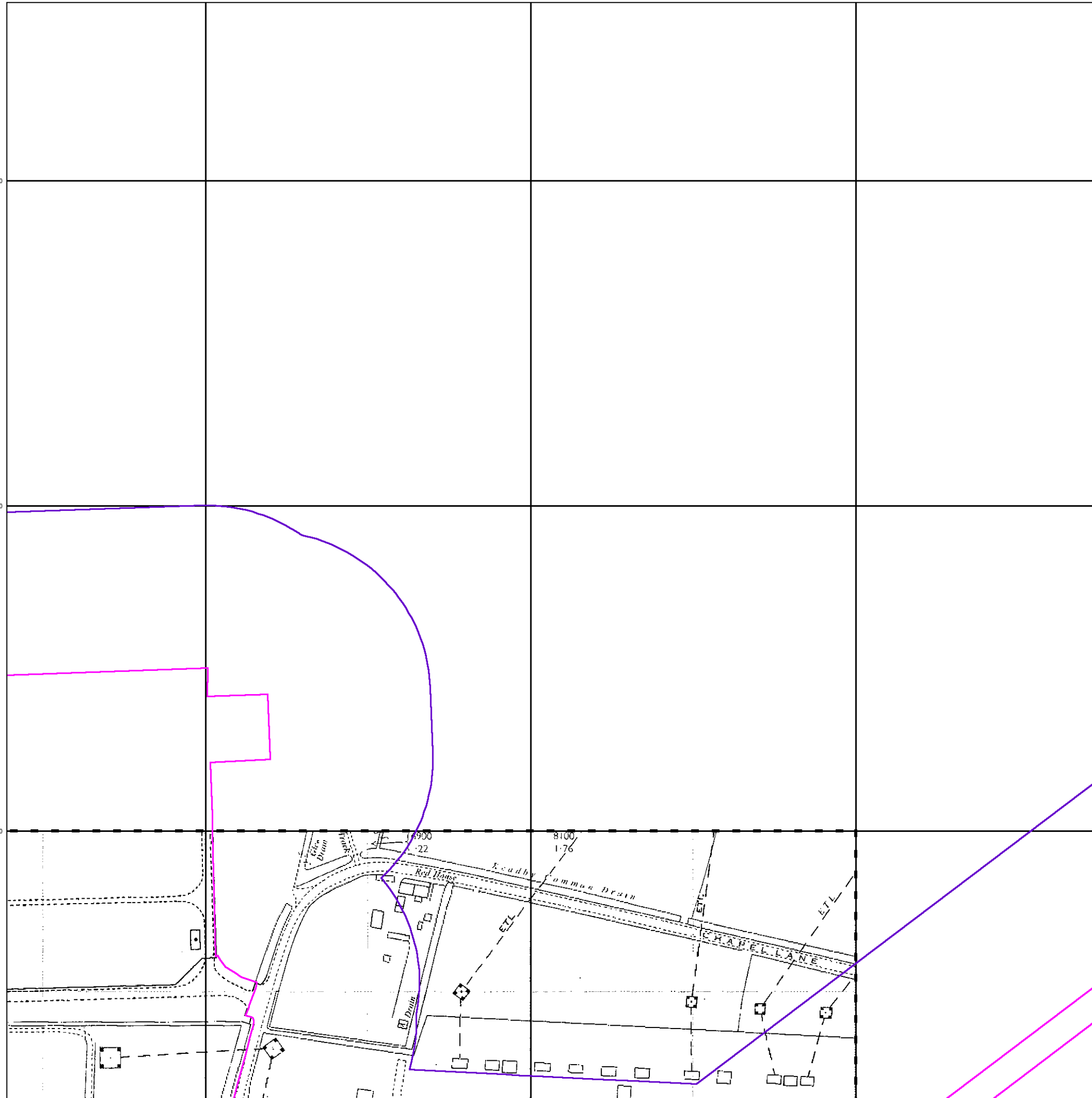



Large-Scale National Grid Data

Published 1994

Source map scale - 1:2,500

'Large Scale National Grid Data' superseded SIM cards (Ordnance Survey's 'Survey of Information on Microfilm') in 1992, and continued to be produced until 1999. These maps were the fore-runners of digital mapping and so provide detailed information on houses and roads, but tend to show less topographic features such as vegetation. These maps were produced at both 1:2,500 and 1:1,250 scales.

Map Name(s) and Date(s)

SE8212 1994 12,500	SE8312 1994 12,500
SE8211 1994 12,500	SE8311 1994 12,500

Historical Map - Segment A12

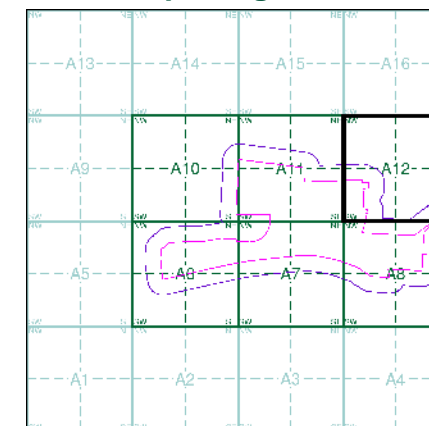

Order Details

Order Number: 242986885_1_1
Customer Ref: 60625943
National Grid Reference: 482060, 411790
Slice: A
Site Area (Ha): 68.12
Search Buffer (m): 100

Site Details

Keadby



Tel: 0844 844 9952
Fax: 0844 844 9951
Web: www.envirocheck.co.uk

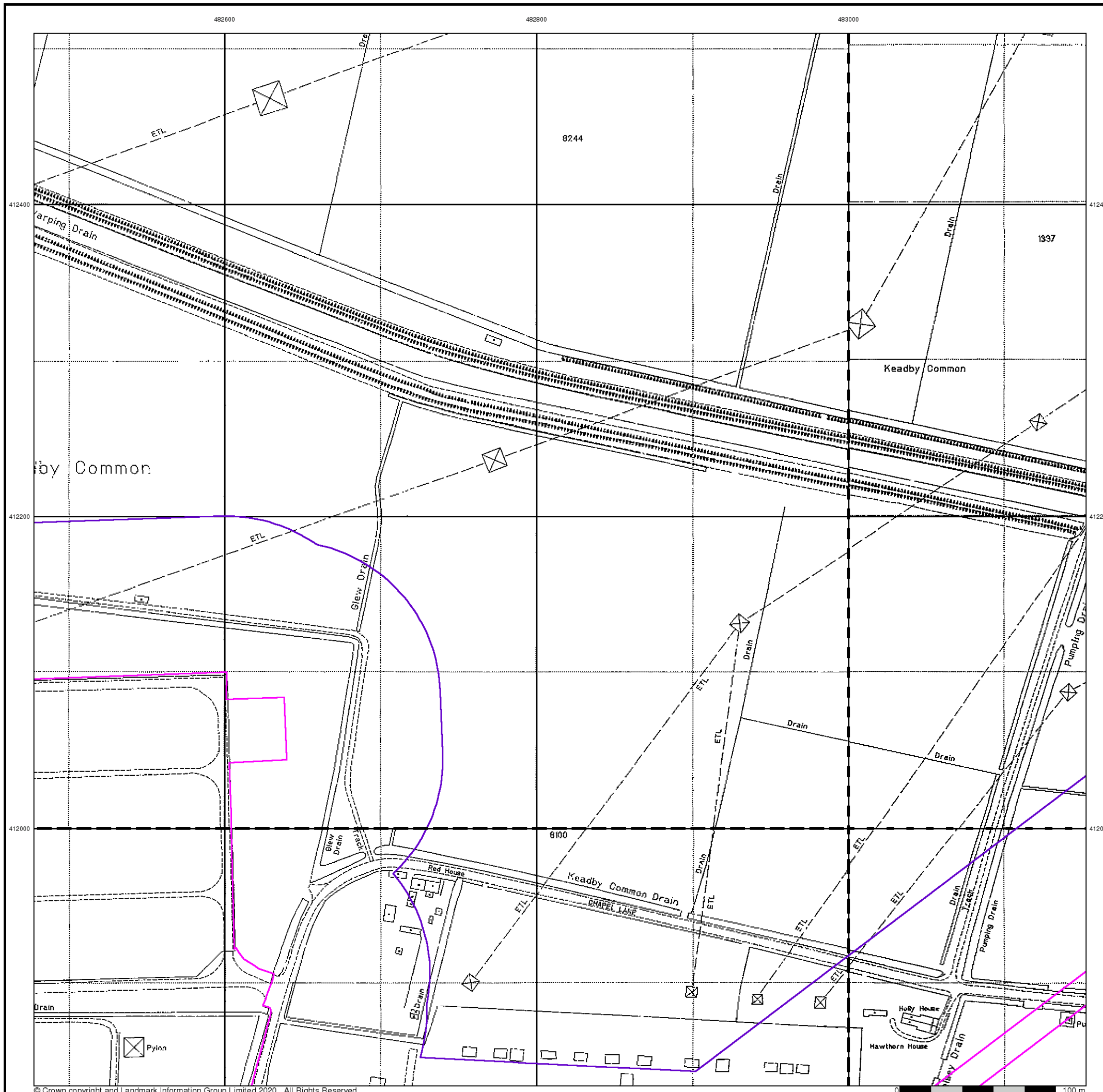



Large-Scale National Grid Data

Published 1995

Source map scale - 1:2,500

'Large Scale National Grid Data' superseded SIM cards (Ordnance Survey's 'Survey of Information on Microfilm') in 1992, and continued to be produced until 1999. These maps were the fore-runners of digital mapping and so provide detailed information on houses and roads, but tend to show less topographic features such as vegetation. These maps were produced at both 1:2,500 and 1:1,250 scales.

Map Name(s) and Date(s)

SE8212	1995	1:2,500
SE8211	1995	1:2,500

Historical Map - Segment A12

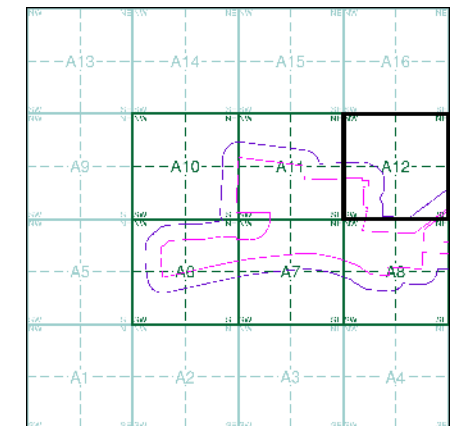

Order Details

Order Number: 242986885_1_1
 Customer Ref: 60625943
 National Grid Reference: 482060, 411790
 Slice: A
 Site Area (Ha): 68.12
 Search Buffer (m): 100

Site Details

Keadby



Tel: 0844 844 9952
 Fax: 0844 844 9951
 Web: www.envirocheck.co.uk





Large-Scale National Grid Data

Published 1995

Source map scale - 1:2,500

'Large Scale National Grid Data' superseded SIM cards (Ordnance Survey's 'Survey of Information on Microfilm') in 1992, and continued to be produced until 1999. These maps were the fore-runners of digital mapping and so provide detailed information on houses and roads, but tend to show less topographic features such as vegetation. These maps were produced at both 1:2,500 and 1:1,250 scales.

Map Name(s) and Date(s)

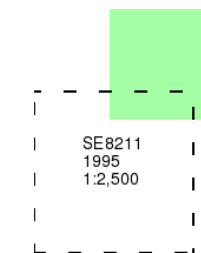

Historical Map - Segment A12

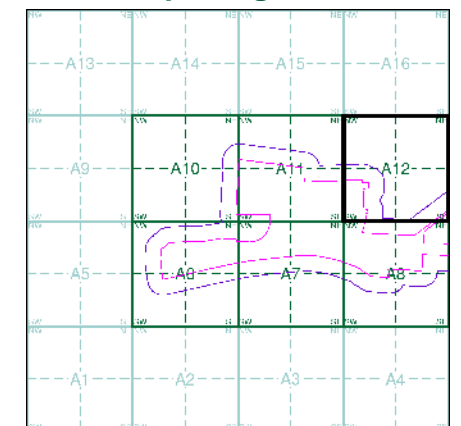

Order Details

Order Number:	242986885_1_1
Customer Ref:	60625943
National Grid Reference:	482060, 411790
Slice:	A
Site Area (Ha):	68.12
Search Buffer (m):	100

Site Details

Keadby



Tel:	0844 844 9952
Fax:	0844 844 9951
Web:	www.envirocheck.co.uk

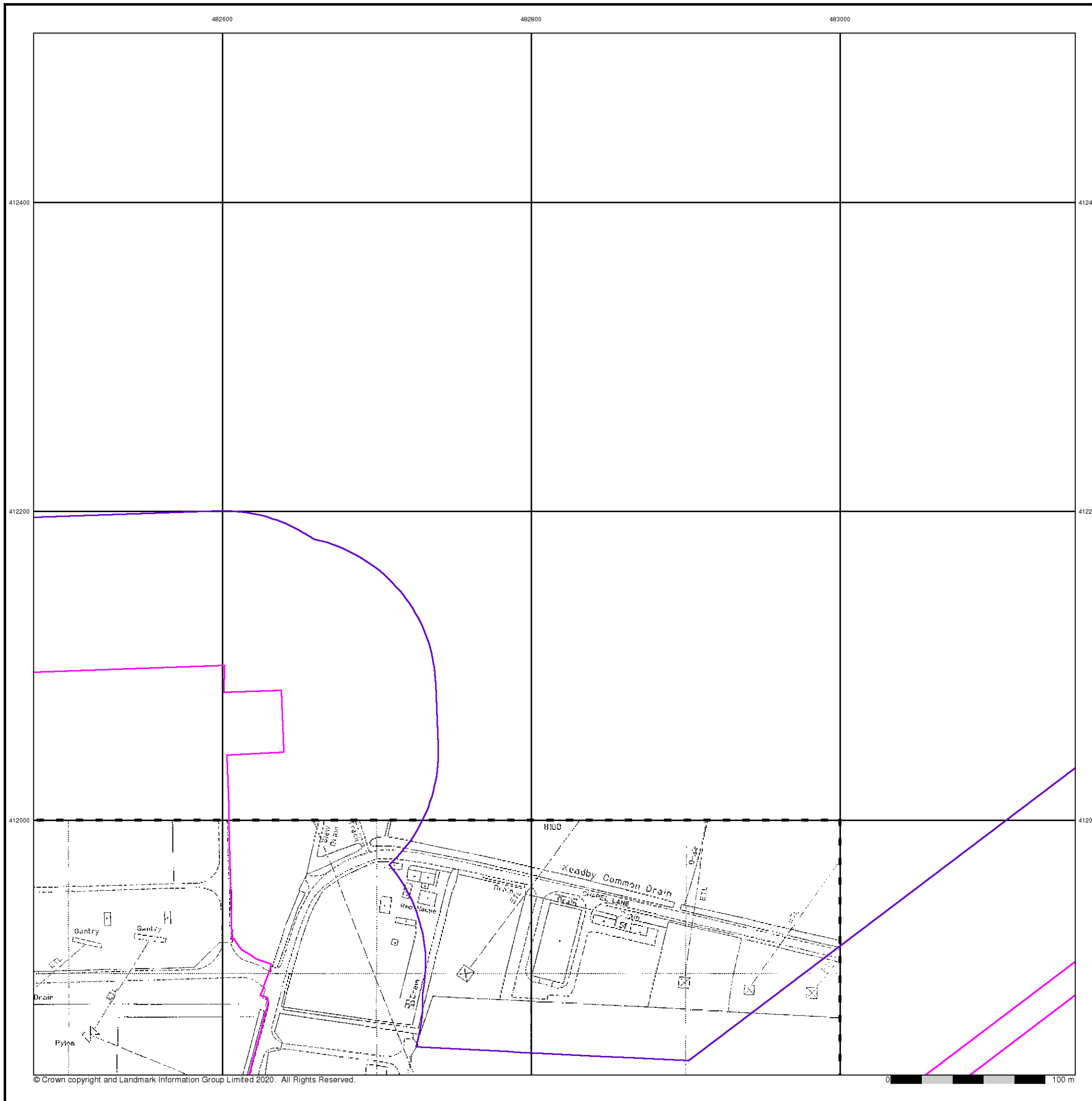



Large-Scale National Grid Data

Published 1996

Source map scale - 1:2,500

'Large Scale National Grid Data' superseded SIM cards (Ordnance Survey's 'Survey of Information on Microfilm') in 1992, and continued to be produced until 1999. These maps were the fore-runners of digital mapping and so provide detailed information on houses and roads, but tend to show less topographic features such as vegetation. These maps were produced at both 1:2,500 and 1:1,250 scales.

Map Name(s) and Date(s)

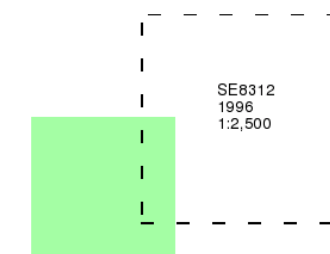

Historical Map - Segment A12

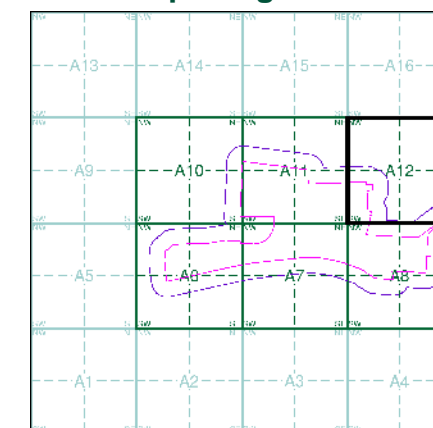

Order Details

Order Number: 242986885_1_1
Customer Ref: 60625943
National Grid Reference: 482060, 411790
Slice: A
Site Area (Ha): 68.12
Search Buffer (m): 100

Site Details

Keadby



Tel: 0844 844 9952
Fax: 0844 844 9951
Web: www.envirocheck.co.uk

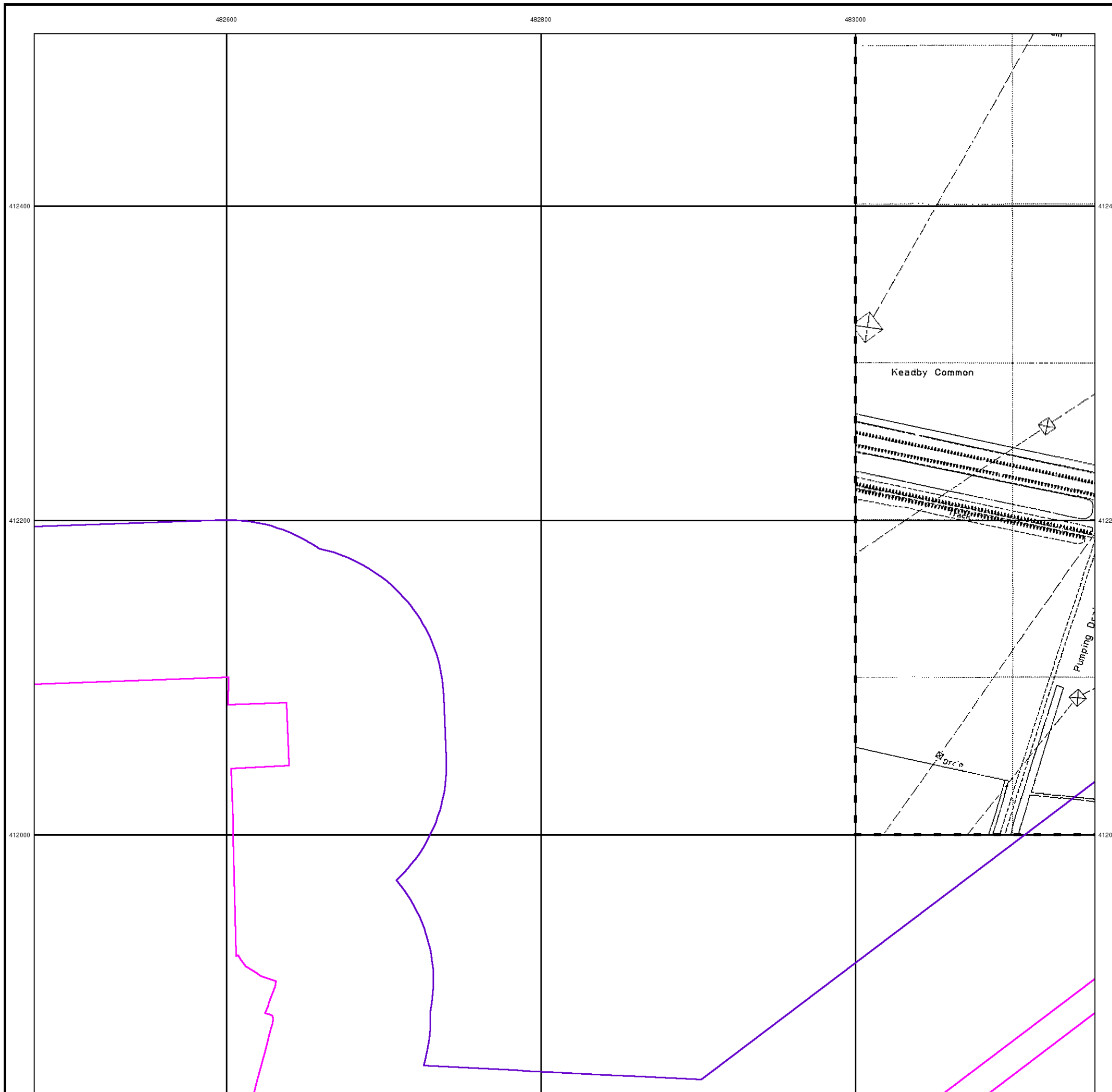



Large-Scale National Grid Data

Published 1996

Source map scale - 1:2,500

'Large Scale National Grid Data' superseded SIM cards (Ordnance Survey's 'Survey of Information on Microfilm') in 1992, and continued to be produced until 1999. These maps were the fore-runners of digital mapping and so provide detailed information on houses and roads, but tend to show less topographic features such as vegetation. These maps were produced at both 1:2,500 and 1:1,250 scales.

Map Name(s) and Date(s)

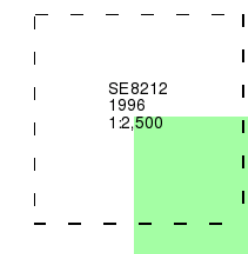

Historical Map - Segment A12

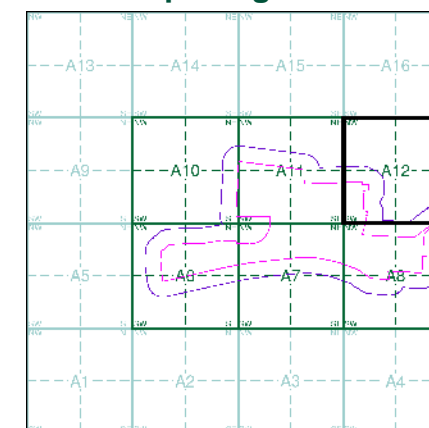

Order Details

Order Number: 242986885_1_1
 Customer Ref: 60625943
 National Grid Reference: 482060, 411790
 Slice: A
 Site Area (Ha): 68.12
 Search Buffer (m): 100

Site Details

Keadby



Tel: 0844 844 9952
 Fax: 0844 844 9951
 Web: www.envirocheck.co.uk

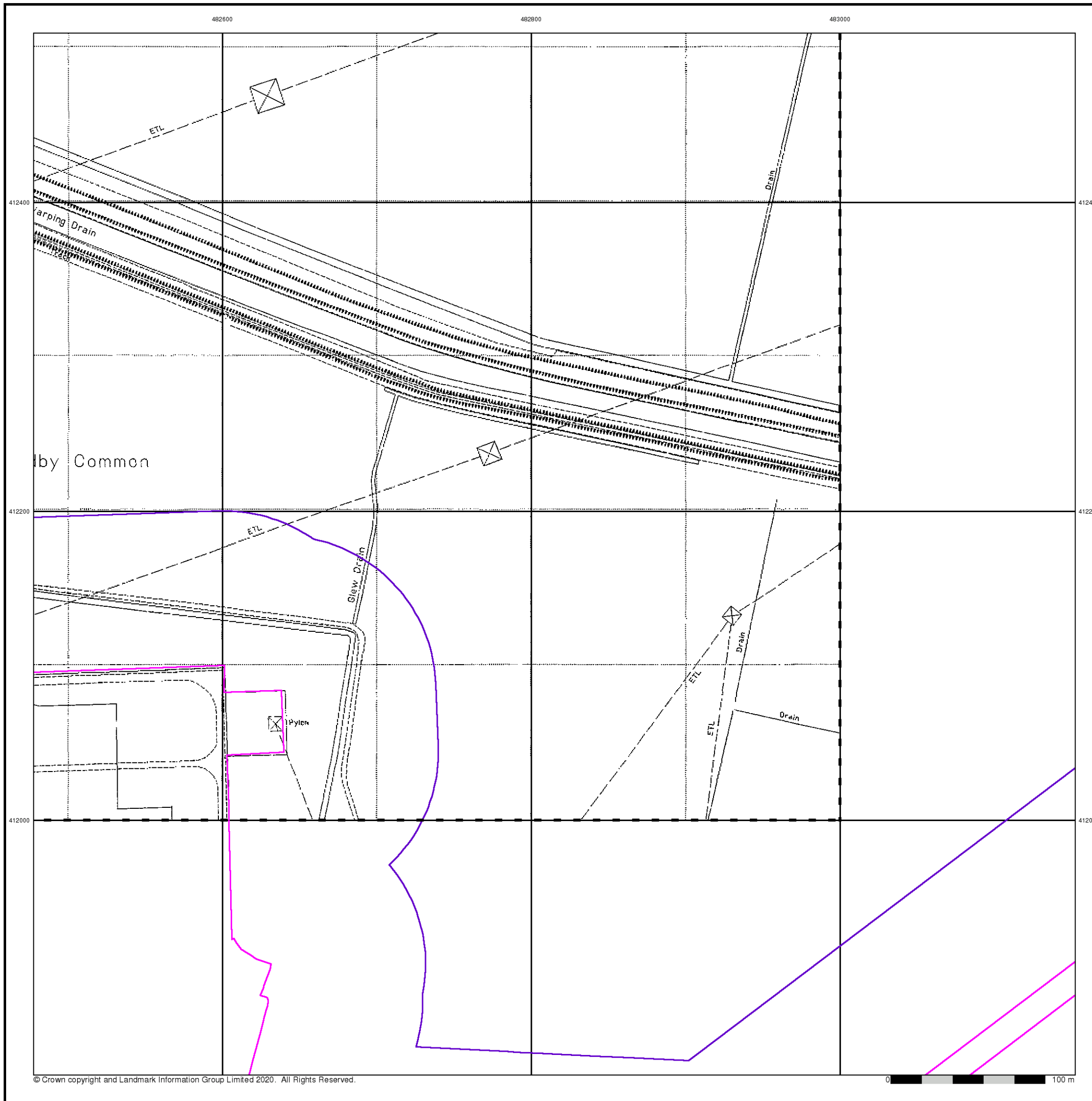

482600

482800

483000



Historical Aerial Photography

Published 1999

This aerial photography was produced by Getmapping, these vertical aerial photographs provide a seamless, full colour survey of the whole of Great Britain

412400

412400

412200

412200

412000

412000

Historical Aerial Photography - Segment A12

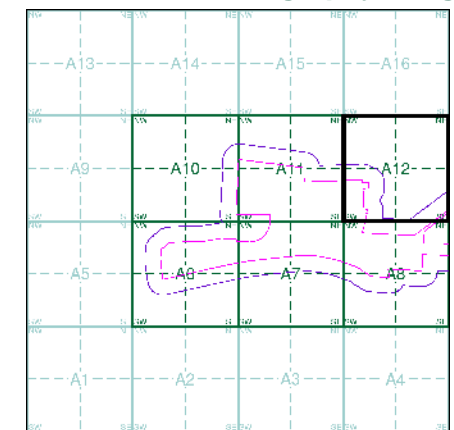

Order Details

Order Number: 242986885_1_1
 Customer Ref: 60625943
 National Grid Reference: 482060, 411790
 Slice: A
 Site Area (Ha): 68.12
 Search Buffer (m): 100

Site Details

Keadby



Tel: 0844 844 9952
 Fax: 0844 844 9951
 Web: www.envirocheck.co.uk



Historical Mapping Legends

Ordnance Survey County Series 1:10,560

- Gravel Pit
- Sand Pit
- Other Pits
- Quarry
- Shingle
- Orchard
- Osiers
- Reeds
- Marsh
- Mixed Wood
- Deciduous
- Brushwood
- Fir
- Furze
- Rough Pasture
- Arrow denotes flow of water
- Trigonometrical Station
- Site of Antiquities
- Bench Mark
- Pump, Guide Post, Signal Post
- Well, Spring, Boundary Post
- 285** Surface Level
- Sketched Contour
- Instrumental Contour
- Main Roads
- Minor Roads
- Sunken Road
- Raised Road
- Road over Railway
- Railway over River
- Railway over Road
- Level Crossing
- Road over River or Canal
- Road over Stream
- Road over Stream
- County Boundary (Geographical)
- County & Civil Parish Boundary
- Administrative County & Civil Parish Boundary
- County Borough Boundary (England)
- County Burgh Boundary (Scotland)
- Rural District Boundary
- Civil Parish Boundary

Ordnance Survey Plan 1:10,000

- Chalk Pit, Clay Pit or Quarry
- Gravel Pit
- Sand Pit
- Disused Pit or Quarry
- Refuse or Slag Heap
- Lake, Loch or Pond
- Dunes
- Boulders
- Coniferous Trees
- Non-Coniferous Trees
- Orchard
- Scrub
- Coppice
- Bracken
- Heath
- Rough Grassland
- Marsh
- Reeds
- Saltings
- Building
- Glasshouse
- Sloping Masonry
- Pylon
- Electricity Transmission Line
- Pole
- Cutting
- Embankment
- Standard Gauge Multiple Track
- Standard Gauge Single Track
- Siding, Tramway or Mineral Line
- Narrow Gauge
- Geographical County
- Administrative County, County Borough or County of City
- Municipal Borough, Urban or Rural District, Burgh or District Council
- Borough, Burgh or County Constituency
- Civil Parish
- BP, BS** Boundary Post or Stone
- Ch** Church
- CH** Club House
- F E Sta** Fire Engine Station
- FB** Foot Bridge
- Fn** Fountain
- GP** Guide Post
- MP** Mile Post
- MS** Mile Stone
- Pol Sta** Police Station
- PO** Post Office
- PC** Public Convenience
- PH** Public House
- SB** Signal Box
- Spr** Spring
- TCB** Telephone Call Box
- TCP** Telephone Call Post
- W** Well

1:10,000 Raster Mapping

- Gravel Pit
- Rock
- Boulders
- Shingle
- Sand
- Slopes
- Refuse tip or slag heap
- Rock (scattered)
- Boulders (scattered)
- Mud
- Sand Pit
- Top of cliff
- Underground detail
- Narrow gauge railway
- Single track railway
- Civil, parish or community boundary
- Constituency boundary
- Area of wooded vegetation
- Non-coniferous trees
- Coniferous trees
- Positioned tree
- Coppice or Osiers
- Heath
- Marsh, Salt Marsh or Reeds
- Flow arrows
- Mean high water (springs)
- Mean low water (springs)
- Electricity transmission line (with poles)
- Triangulation station
- Pylon, flare stack or lighting tower
- Glasshouse
- Important Building
- General Building



Historical Mapping & Photography included:

Mapping Type	Scale	Date	Pg
Yorkshire	1:10,560	1854	2
Lincolnshire	1:10,560	1886	3
Lincolnshire	1:10,560	1907 - 1908	4
Lincolnshire	1:10,560	1938 - 1946	5
Lincolnshire	1:10,560	1951	6
Lincolnshire	1:10,560	1951	7
Ordnance Survey Plan	1:10,000	1956	8
Ordnance Survey Plan	1:10,000	1969	9
Ordnance Survey Plan	1:10,000	1971	10
Ordnance Survey Plan	1:10,000	1982 - 1987	11
Ordnance Survey Plan	1:10,000	1991	12
10K Raster Mapping	1:10,000	2000	13
10K Raster Mapping	1:10,000	2006	14
VectorMap Local	1:10,000	2020	15

Historical Map - Slice B

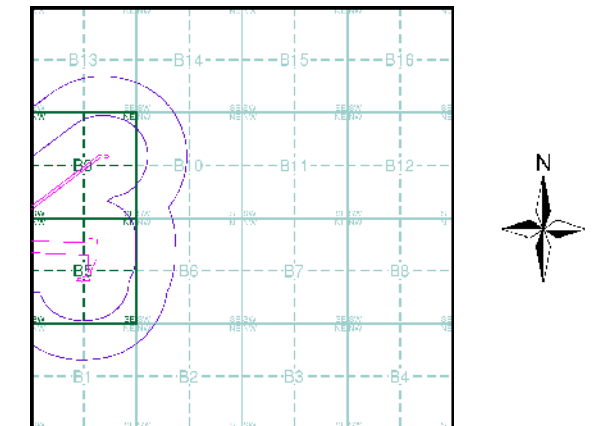

Order Details

Order Number: 242986885_1_1
 Customer Ref: 60625943
 National Grid Reference: 483610, 411850
 Slice: B
 Site Area (Ha): 68.12
 Search Buffer (m): 500

Site Details

Keadby



Tel: 0844 844 9952
 Fax: 0844 844 9951
 Web: www.envirocheck.co.uk



Yorkshire

Published 1854

Source map scale - 1:10,560

The historical maps shown were reproduced from maps predominantly held at the scale adopted for England, Wales and Scotland in the 1840's. In 1854 the 1:2,500 scale was adopted for mapping urban areas; these maps were used to update the 1:10,560 maps. The published date given therefore is often some years later than the surveyed date. Before 1938, all OS maps were based on the Cassini Projection, with independent surveys of a single county or group of counties, giving rise to significant inaccuracies in outlying areas. In the late 1940's, a Provisional Edition was produced, which updated the 1:10,560 mapping from a number of sources. The maps appear unfinished - with all military camps and other strategic sites removed. These maps were initially overprinted with the National Grid. In 1970, the first 1:10,000 maps were produced using the Transverse Mercator Projection. The revision process continued until recently, with new editions appearing every 10 years or so for urban areas.

Map Name(s) and Date(s)

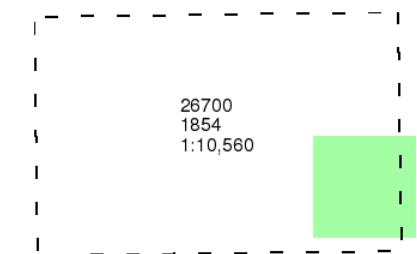

Historical Map - Slice B

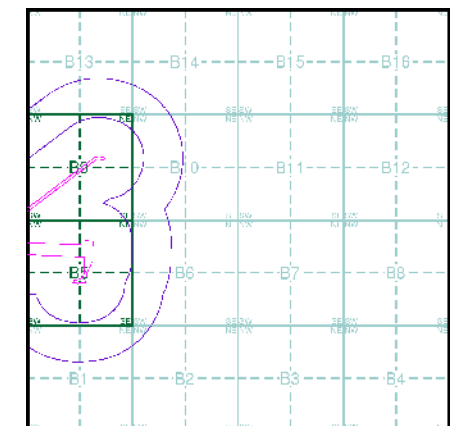

Order Details

Order Number: 242986885_1_1
Customer Ref: 60625943
National Grid Reference: 483610, 411850
Slice: B
Site Area (Ha): 68.12
Search Buffer (m): 500

Site Details

Keadby



Tel: 0844 844 9952
Fax: 0844 844 9951
Web: www.envirocheck.co.uk

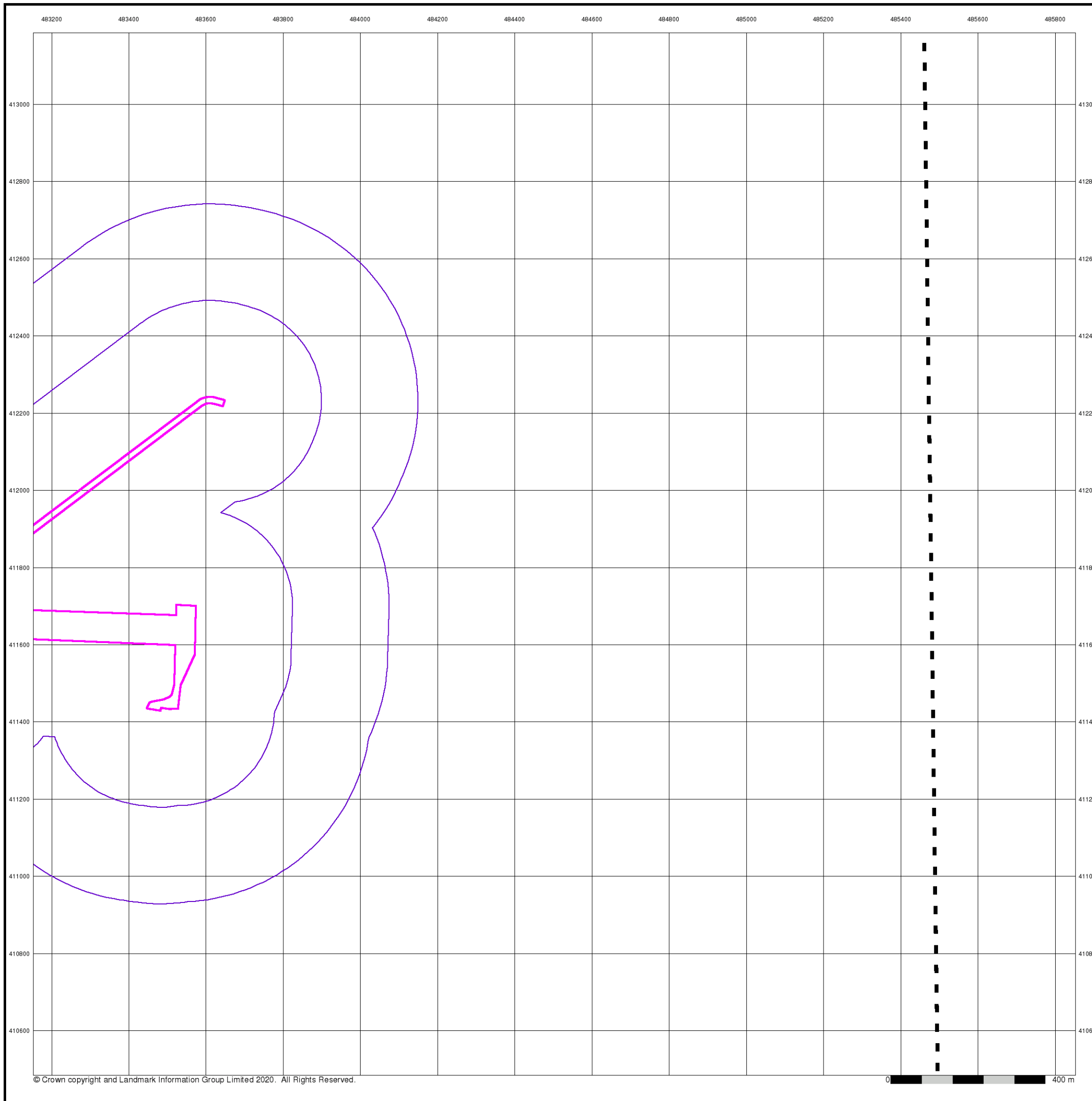



Lincolnshire

Published 1886

Source map scale - 1:10,560

The historical maps shown were reproduced from maps predominantly held at the scale adopted for England, Wales and Scotland in the 1840's. In 1854 the 1:2,500 scale was adopted for mapping urban areas; these maps were used to update the 1:10,560 maps. The published date given therefore is often some years later than the surveyed date. Before 1938, all OS maps were based on the Cassini Projection, with independent surveys of a single county or group of counties, giving rise to significant inaccuracies in outlying areas. In the late 1940's, a Provisional Edition was produced, which updated the 1:10,560 mapping from a number of sources. The maps appear unfinished - with all military camps and other strategic sites removed. These maps were initially overprinted with the National Grid. In 1970, the first 1:10,000 maps were produced using the Transverse Mercator Projection. The revision process continued until recently, with new editions appearing every 10 years or so for urban areas.

Map Name(s) and Date(s)

010SW	1886	1:10,560
018NW	1886	1:10,560

Historical Map - Slice B

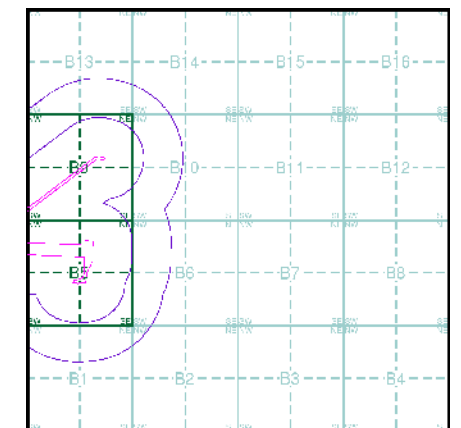

Order Details

Order Number: 242986885_1_1
 Customer Ref: 60625943
 National Grid Reference: 483610, 411850
 Slice: B
 Site Area (Ha): 68.12
 Search Buffer (m): 500

Site Details

Keadby



Tel: 0844 844 9952
 Fax: 0844 844 9951
 Web: www.envirocheck.co.uk

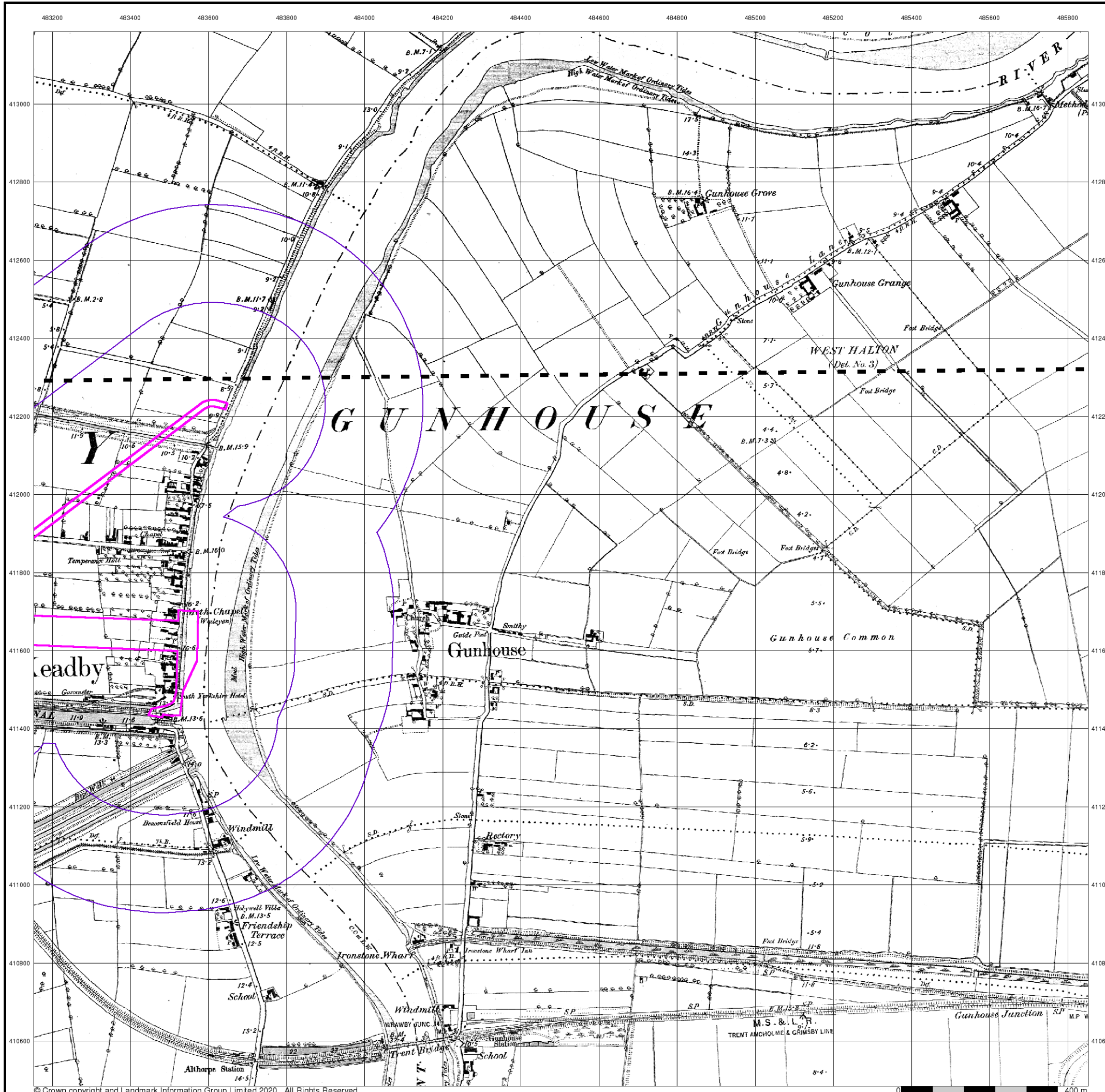



Lincolnshire

Published 1907 - 1908

Source map scale - 1:10,560

The historical maps shown were reproduced from maps predominantly held at the scale adopted for England, Wales and Scotland in the 1840's. In 1854 the 1:2,500 scale was adopted for mapping urban areas; these maps were used to update the 1:10,560 maps. The published date given therefore is often some years later than the surveyed date. Before 1938, all OS maps were based on the Cassini Projection, with independent surveys of a single county or group of counties, giving rise to significant inaccuracies in outlying areas. In the late 1940's, a Provisional Edition was produced, which updated the 1:10,560 mapping from a number of sources. The maps appear unfinished - with all military camps and other strategic sites removed. These maps were initially overprinted with the National Grid. In 1970, the first 1:10,000 maps were produced using the Transverse Mercator Projection. The revision process continued until recently, with new editions appearing every 10 years or so for urban areas.

Map Name(s) and Date(s)

010SW	1908	1:10,560
018NW	1907	1:10,560

Historical Map - Slice B

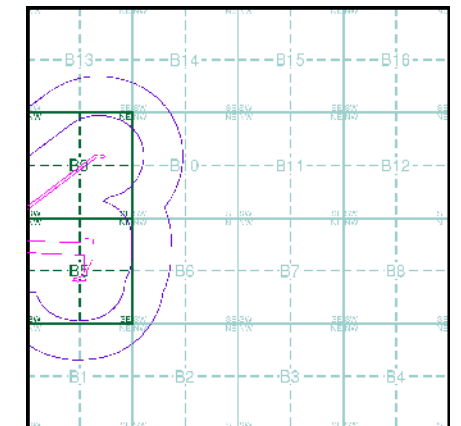

Order Details

Order Number: 242986885_1_1
 Customer Ref: 60625943
 National Grid Reference: 483610, 411850
 Slice: B
 Site Area (Ha): 68.12
 Search Buffer (m): 500

Site Details

Keabby



Tel: 0844 844 9952
 Fax: 0844 844 9951
 Web: www.envirocheck.co.uk

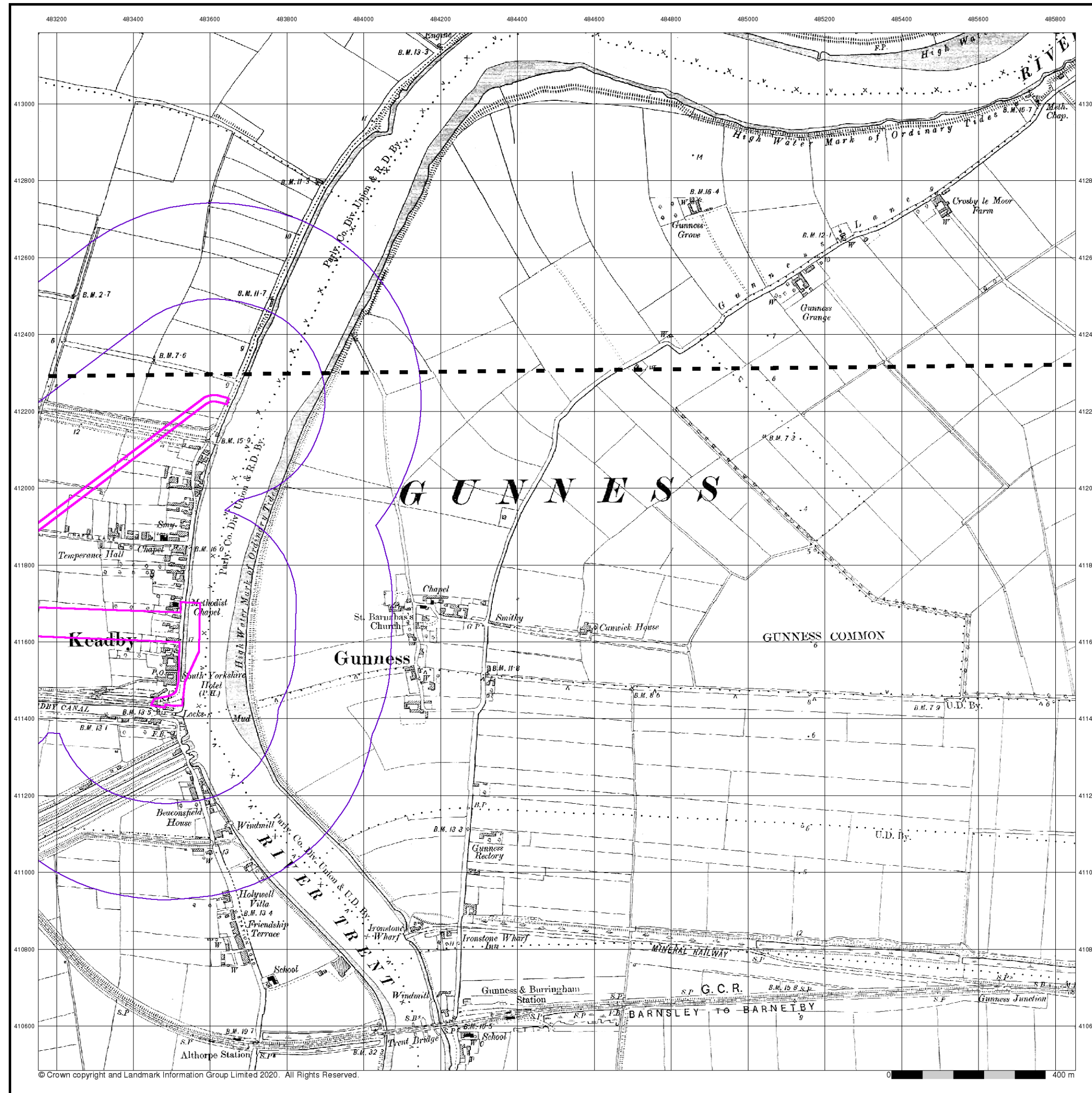



Lincolnshire

Published 1938 - 1946

Source map scale - 1:10,560

The historical maps shown were reproduced from maps predominantly held at the scale adopted for England, Wales and Scotland in the 1840's. In 1854 the 1:2,500 scale was adopted for mapping urban areas; these maps were used to update the 1:10,560 maps. The published date given therefore is often some years later than the surveyed date. Before 1938, all OS maps were based on the Cassini Projection, with independent surveys of a single county or group of counties, giving rise to significant inaccuracies in outlying areas. In the late 1940's, a Provisional Edition was produced, which updated the 1:10,560 mapping from a number of sources. The maps appear unfinished - with all military camps and other strategic sites removed. These maps were initially overprinted with the National Grid. In 1970, the first 1:10,000 maps were produced using the Transverse Mercator Projection. The revision process continued until recently, with new editions appearing every 10 years or so for urban areas.

Map Name(s) and Date(s)

010SW	1946	1:10,560
018NW	1938	1:10,560

Historical Map - Slice B

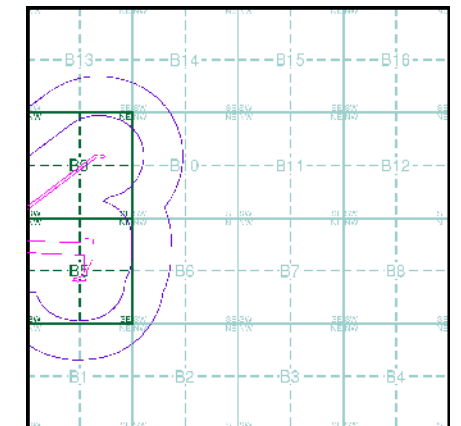

Order Details

Order Number: 242986885_1_1
 Customer Ref: 60625943
 National Grid Reference: 483610, 411850
 Slice: B
 Site Area (Ha): 68.12
 Search Buffer (m): 500

Site Details

Keadby



Tel: 0844 844 9952
 Fax: 0844 844 9951
 Web: www.envirocheck.co.uk

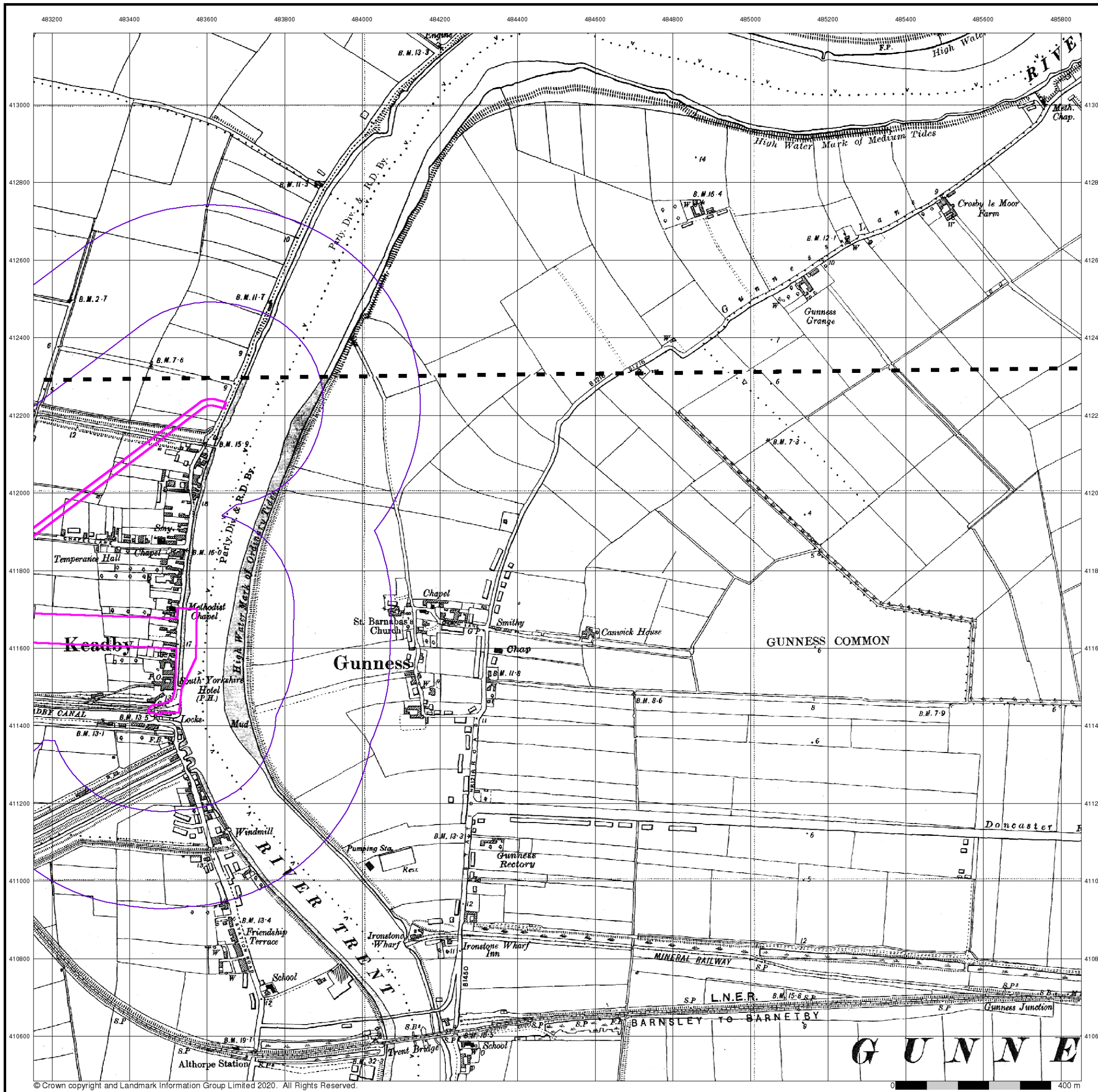



Lincolnshire

Published 1951

Source map scale - 1:10,560

The historical maps shown were reproduced from maps predominantly held at the scale adopted for England, Wales and Scotland in the 1840's. In 1854 the 1:2,500 scale was adopted for mapping urban areas; these maps were used to update the 1:10,560 maps. The published date given therefore is often some years later than the surveyed date. Before 1938, all OS maps were based on the Cassini Projection, with independent surveys of a single county or group of counties, giving rise to significant inaccuracies in outlying areas. In the late 1940's, a Provisional Edition was produced, which updated the 1:10,560 mapping from a number of sources. The maps appear unfinished - with all military camps and other strategic sites removed. These maps were initially overprinted with the National Grid. In 1970, the first 1:10,000 maps were produced using the Transverse Mercator Projection. The revision process continued until recently, with new editions appearing every 10 years or so for urban areas.

Map Name(s) and Date(s)

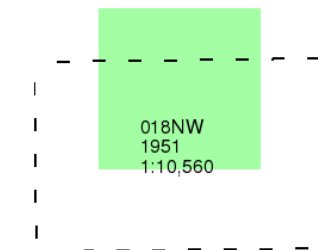

Historical Map - Slice B

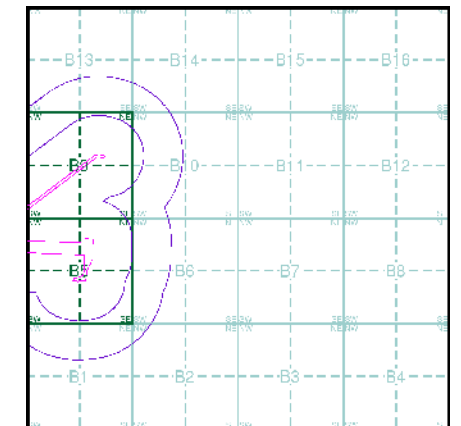

Order Details

Order Number: 242986885_1_1
Customer Ref: 60625943
National Grid Reference: 483610, 411850
Slice: B
Site Area (Ha): 68.12
Search Buffer (m): 500

Site Details

Keadby



Tel: 0844 844 9952
Fax: 0844 844 9951
Web: www.envirocheck.co.uk

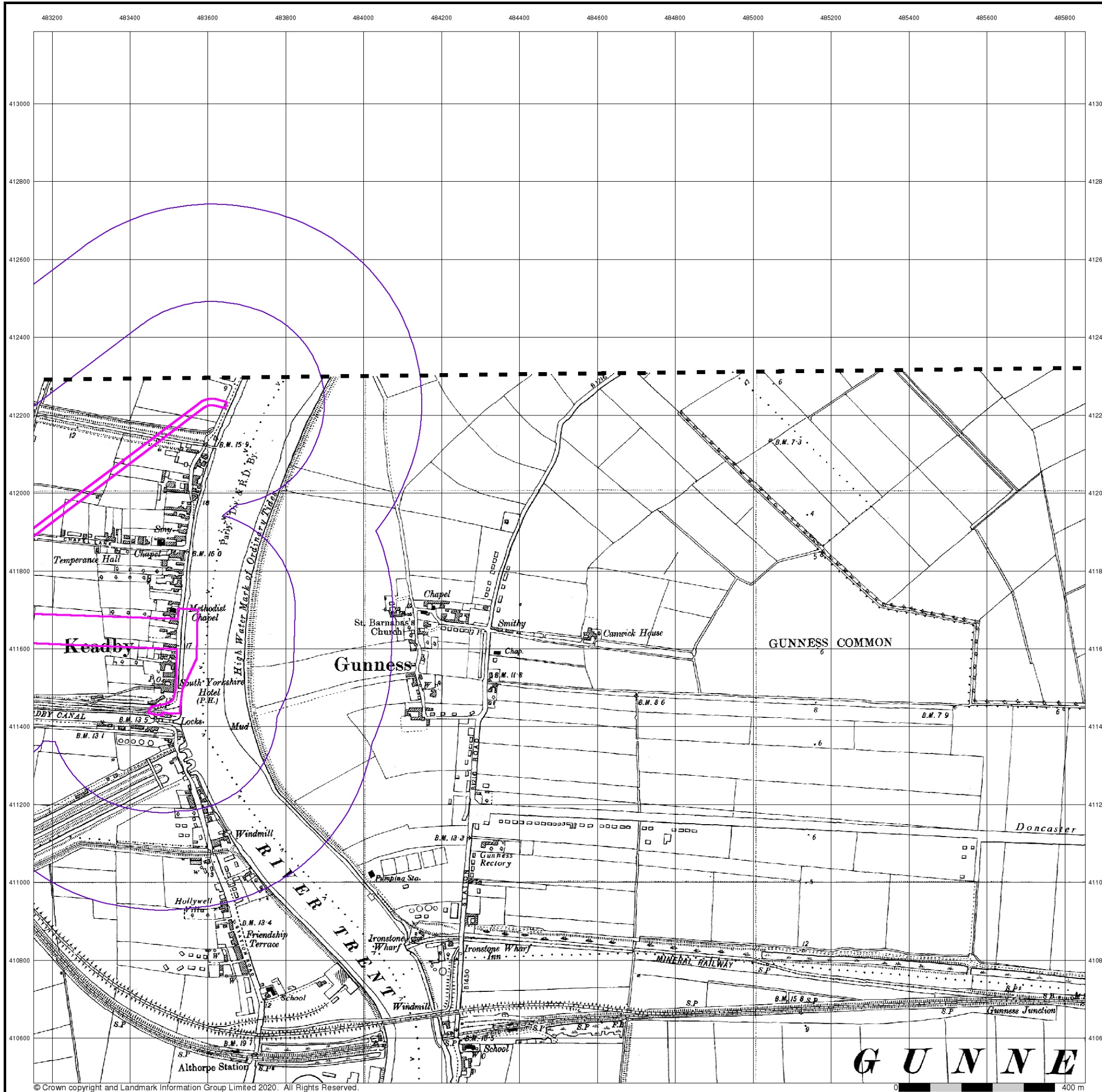

G U N N E



Lincolnshire

Published 1951

Source map scale - 1:10,560

The historical maps shown were reproduced from maps predominantly held at the scale adopted for England, Wales and Scotland in the 1840's. In 1854 the 1:2,500 scale was adopted for mapping urban areas; these maps were used to update the 1:10,560 maps. The published date given therefore is often some years later than the surveyed date. Before 1938, all OS maps were based on the Cassini Projection, with independent surveys of a single county or group of counties, giving rise to significant inaccuracies in outlying areas. In the late 1940's, a Provisional Edition was produced, which updated the 1:10,560 mapping from a number of sources. The maps appear unfinished - with all military camps and other strategic sites removed. These maps were initially overprinted with the National Grid. In 1970, the first 1:10,000 maps were produced using the Transverse Mercator Projection. The revision process continued until recently, with new editions appearing every 10 years or so for urban areas.

Map Name(s) and Date(s)

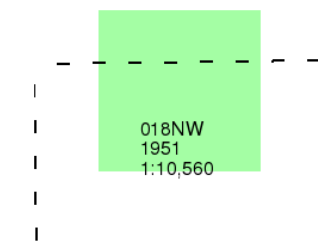

Historical Map - Slice B

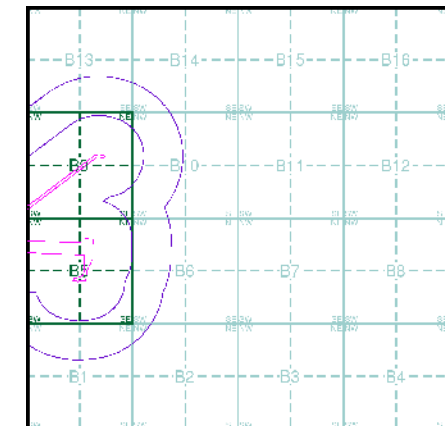

Order Details

Order Number: 242986885_1_1
Customer Ref: 60625943
National Grid Reference: 483610, 411850
Slice: B
Site Area (Ha): 68.12
Search Buffer (m): 500

Site Details

Keadby



Tel: 0844 844 9952
Fax: 0844 844 9951
Web: www.envirocheck.co.uk

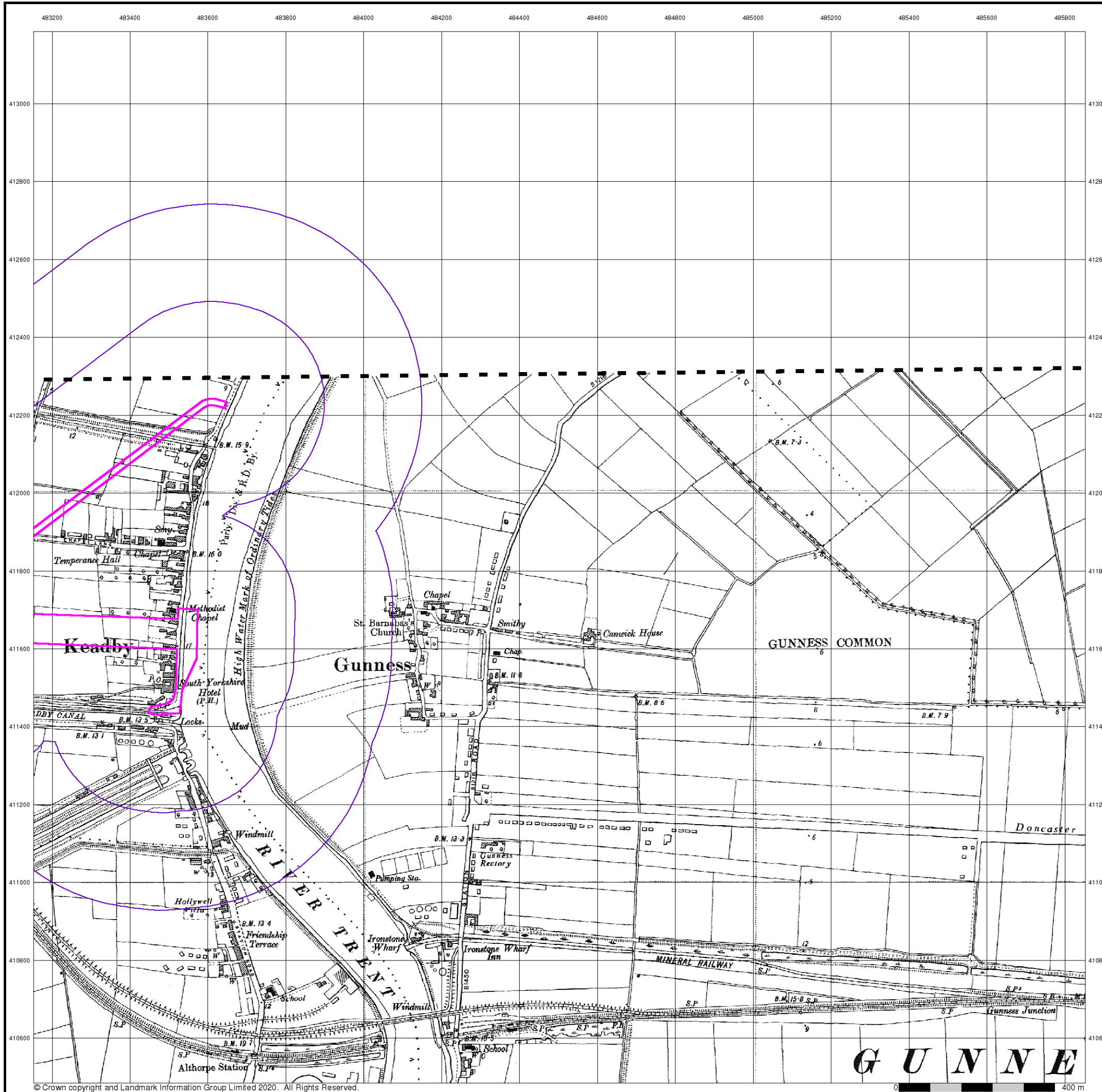

G U N N E



Ordnance Survey Plan

Published 1956

Source map scale - 1:10,000

The historical maps shown were reproduced from maps predominantly held at the scale adopted for England, Wales and Scotland in the 1840's. In 1854 the 1:2,500 scale was adopted for mapping urban areas; these maps were used to update the 1:10,560 maps. The published date given therefore is often some years later than the surveyed date. Before 1938, all OS maps were based on the Cassini Projection, with independent surveys of a single county or group of counties, giving rise to significant inaccuracies in outlying areas. In the late 1940's, a Provisional Edition was produced, which updated the 1:10,560 mapping from a number of sources. The maps appear unfinished - with all military camps and other strategic sites removed. These maps were initially overprinted with the National Grid. In 1970, the first 1:10,000 maps were produced using the Transverse Mercator Projection. The revision process continued until recently, with new editions appearing every 10 years or so for urban areas.

Map Name(s) and Date(s)

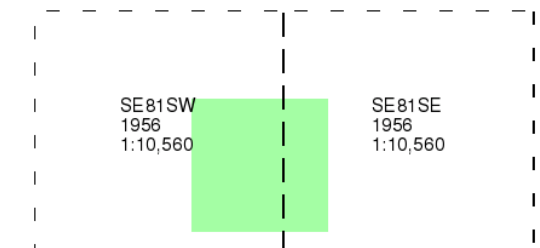

Historical Map - Slice B

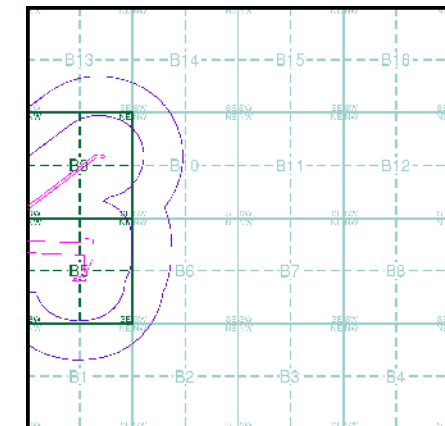

Order Details

Order Number: 242986885_1_1
Customer Ref: 60625943
National Grid Reference: 483610, 411850
Slice: B
Site Area (Ha): 68.12
Search Buffer (m): 500

Site Details

Keadby



Tel: 0844 844 9952
Fax: 0844 844 9951
Web: www.envirocheck.co.uk

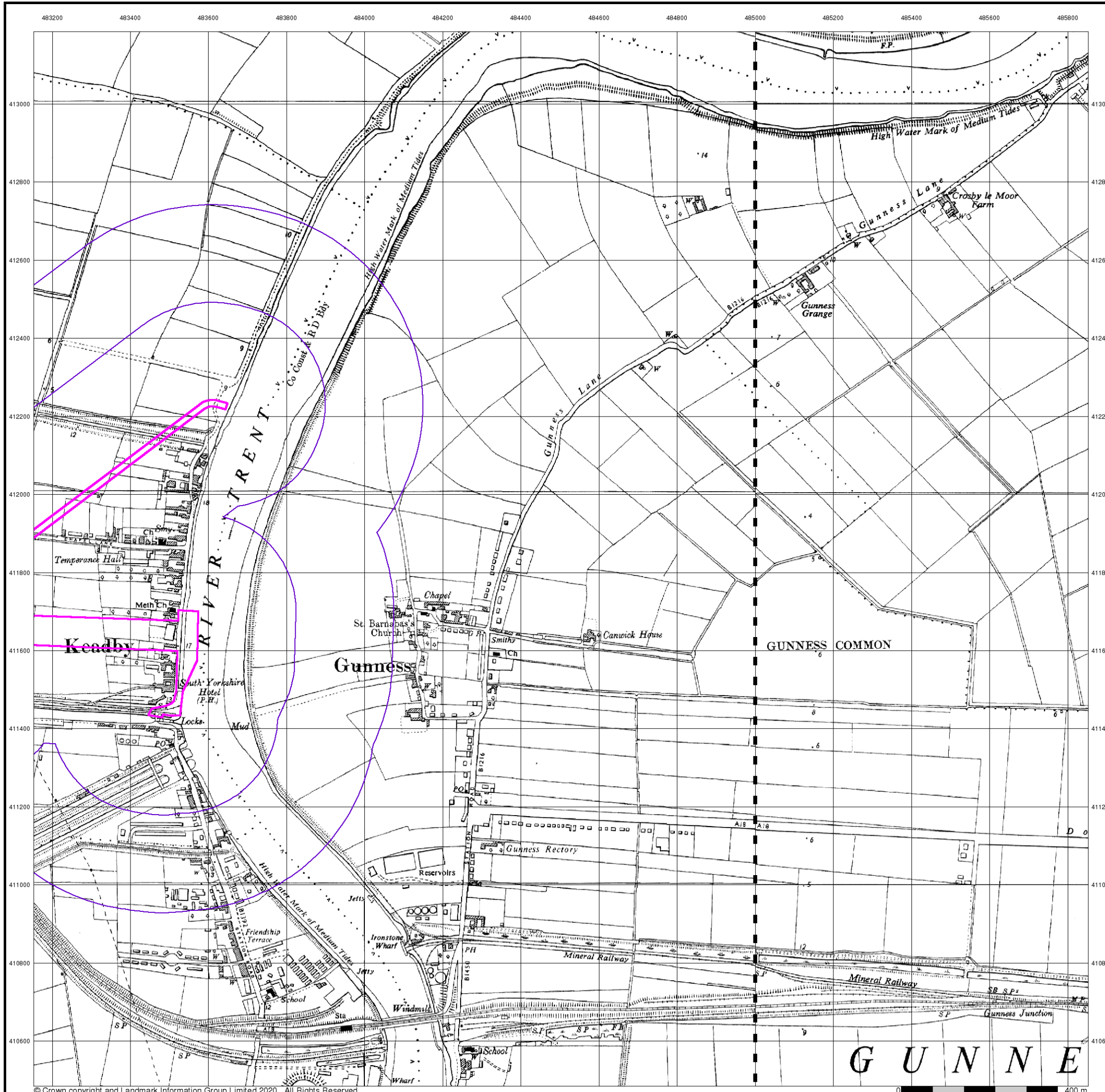



Ordnance Survey Plan

Published 1969

Source map scale - 1:10,000

The historical maps shown were reproduced from maps predominantly held at the scale adopted for England, Wales and Scotland in the 1840's. In 1854 the 1:2,500 scale was adopted for mapping urban areas; these maps were used to update the 1:10,560 maps. The published date given therefore is often some years later than the surveyed date. Before 1938, all OS maps were based on the Cassini Projection, with independent surveys of a single county or group of counties, giving rise to significant inaccuracies in outlying areas. In the late 1940's, a Provisional Edition was produced, which updated the 1:10,560 mapping from a number of sources. The maps appear unfinished - with all military camps and other strategic sites removed. These maps were initially overprinted with the National Grid. In 1970, the first 1:10,000 maps were produced using the Transverse Mercator Projection. The revision process continued until recently, with new editions appearing every 10 years or so for urban areas.

Map Name(s) and Date(s)

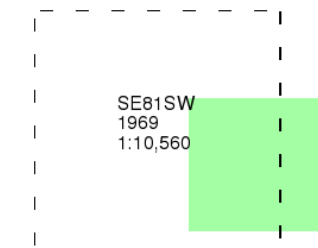

Historical Map - Slice B

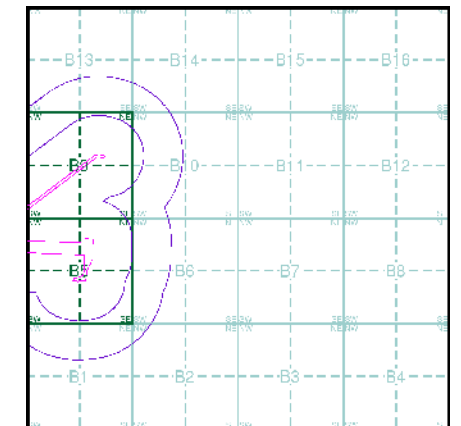

Order Details

Order Number: 242986885_1_1
Customer Ref: 60625943
National Grid Reference: 483610, 411850
Slice: B
Site Area (Ha): 68.12
Search Buffer (m): 500

Site Details

Keadby



Tel: 0844 844 9952
Fax: 0844 844 9951
Web: www.envirocheck.co.uk

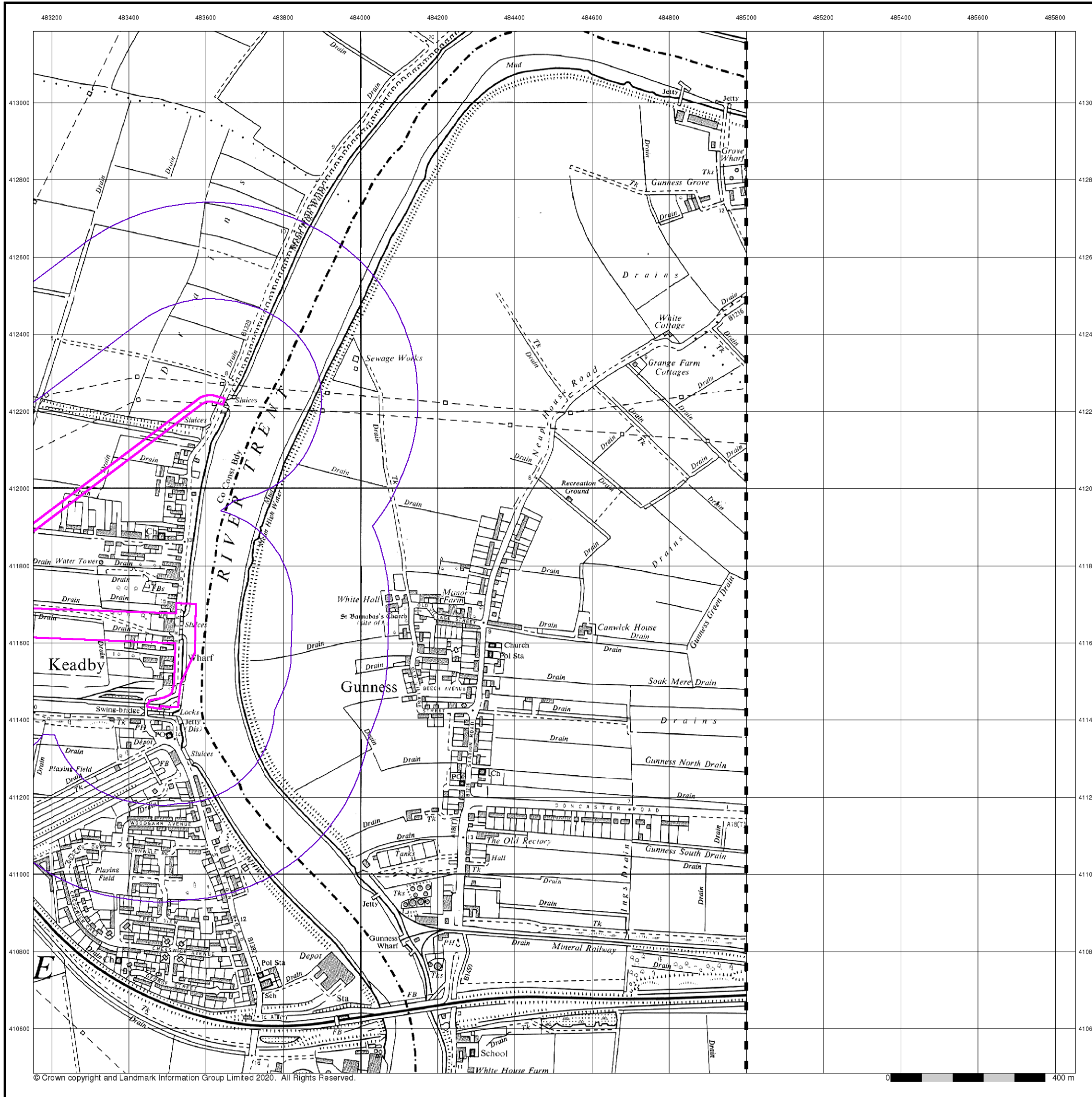



Ordnance Survey Plan

Published 1971

Source map scale - 1:10,000

The historical maps shown were reproduced from maps predominantly held at the scale adopted for England, Wales and Scotland in the 1840's. In 1854 the 1:2,500 scale was adopted for mapping urban areas; these maps were used to update the 1:10,560 maps. The published date given therefore is often some years later than the surveyed date. Before 1938, all OS maps were based on the Cassini Projection, with independent surveys of a single county or group of counties, giving rise to significant inaccuracies in outlying areas. In the late 1940's, a Provisional Edition was produced, which updated the 1:10,560 mapping from a number of sources. The maps appear unfinished - with all military camps and other strategic sites removed. These maps were initially overprinted with the National Grid. In 1970, the first 1:10,000 maps were produced using the Transverse Mercator Projection. The revision process continued until recently, with new editions appearing every 10 years or so for urban areas.

Map Name(s) and Date(s)

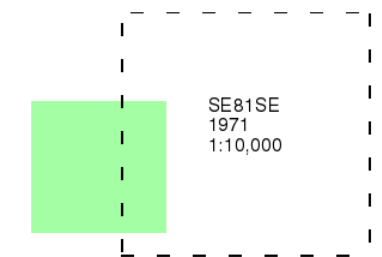

Historical Map - Slice B

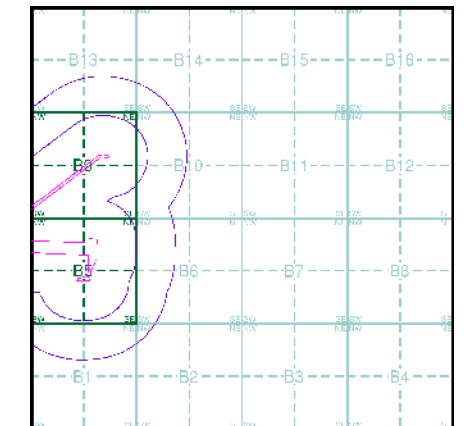

Order Details

Order Number: 242986885_1_1
Customer Ref: 60625943
National Grid Reference: 483610, 411850
Slice: B
Site Area (Ha): 68.12
Search Buffer (m): 500

Site Details

Keabby



Tel: 0844 844 9952
Fax: 0844 844 9951
Web: www.envirocheck.co.uk

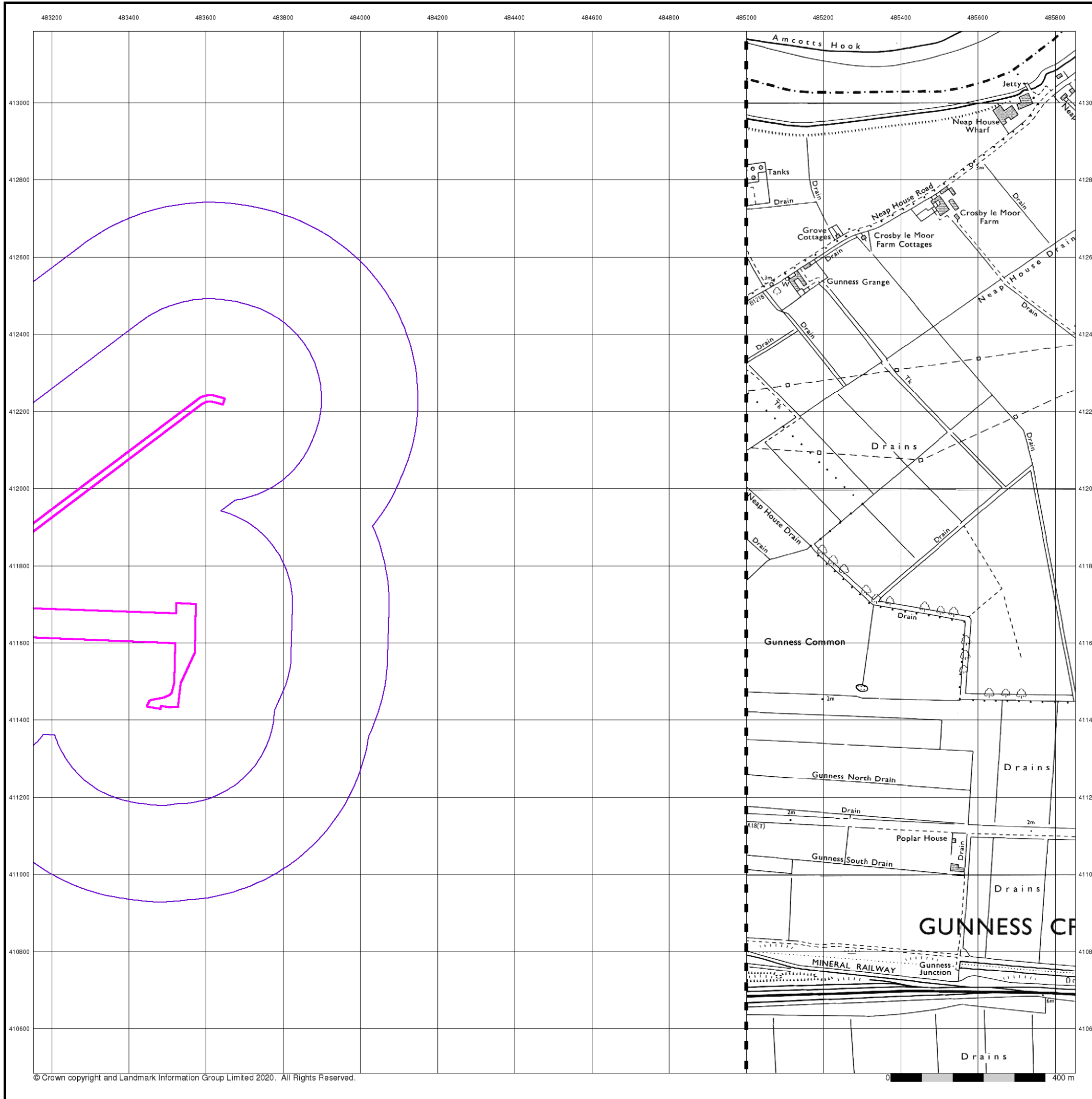



Ordnance Survey Plan

Published 1982 - 1987

Source map scale - 1:10,000

The historical maps shown were reproduced from maps predominantly held at the scale adopted for England, Wales and Scotland in the 1840's. In 1854 the 1:2,500 scale was adopted for mapping urban areas; these maps were used to update the 1:10,560 maps. The published date given therefore is often some years later than the surveyed date. Before 1938, all OS maps were based on the Cassini Projection, with independent surveys of a single county or group of counties, giving rise to significant inaccuracies in outlying areas. In the late 1940's, a Provisional Edition was produced, which updated the 1:10,560 mapping from a number of sources. The maps appear unfinished - with all military camps and other strategic sites removed. These maps were initially overprinted with the National Grid. In 1970, the first 1:10,000 maps were produced using the Transverse Mercator Projection. The revision process continued until recently, with new editions appearing every 10 years or so for urban areas.

Map Name(s) and Date(s)

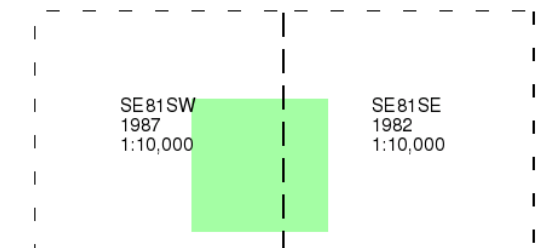

Historical Map - Slice B

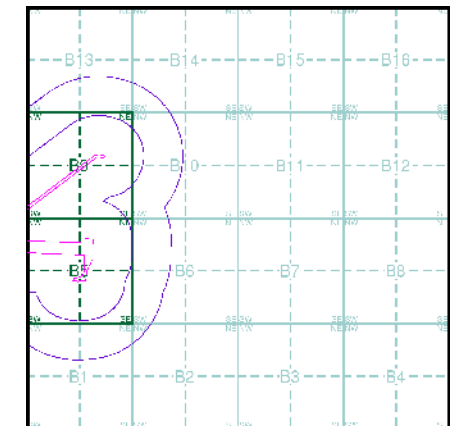

Order Details

Order Number: 242986885_1_1
Customer Ref: 60625943
National Grid Reference: 483610, 411850
Slice: B
Site Area (Ha): 68.12
Search Buffer (m): 500

Site Details

Keadby



Tel: 0844 844 9952
Fax: 0844 844 9951
Web: www.envirocheck.co.uk

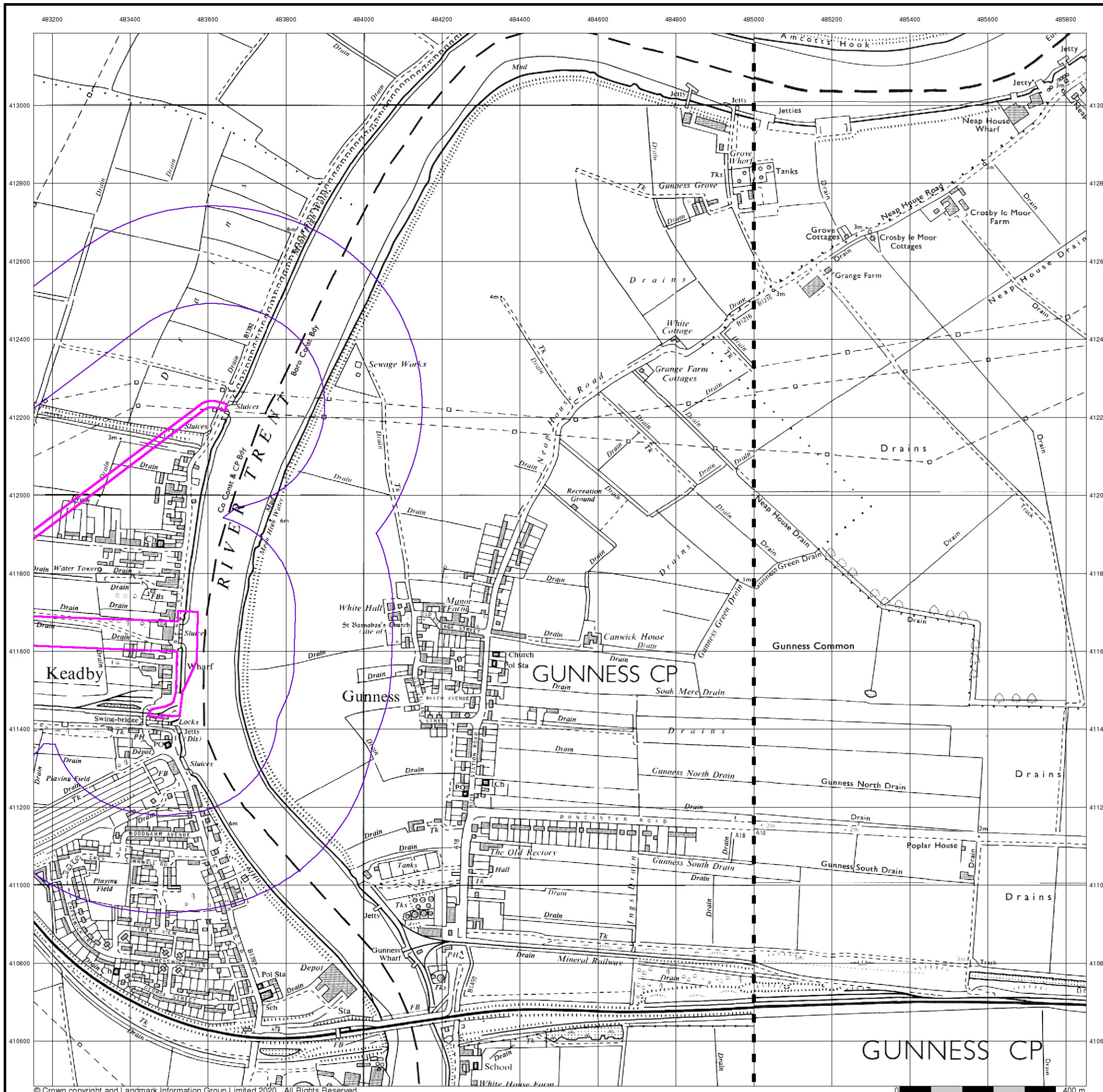



Ordnance Survey Plan

Published 1991

Source map scale - 1:10,000

The historical maps shown were reproduced from maps predominantly held at the scale adopted for England, Wales and Scotland in the 1840's. In 1854 the 1:2,500 scale was adopted for mapping urban areas; these maps were used to update the 1:10,560 maps. The published date given therefore is often some years later than the surveyed date. Before 1938, all OS maps were based on the Cassini Projection, with independent surveys of a single county or group of counties, giving rise to significant inaccuracies in outlying areas. In the late 1940's, a Provisional Edition was produced, which updated the 1:10,560 mapping from a number of sources. The maps appear unfinished - with all military camps and other strategic sites removed. These maps were initially overprinted with the National Grid. In 1970, the first 1:10,000 maps were produced using the Transverse Mercator Projection. The revision process continued until recently, with new editions appearing every 10 years or so for urban areas.

Map Name(s) and Date(s)

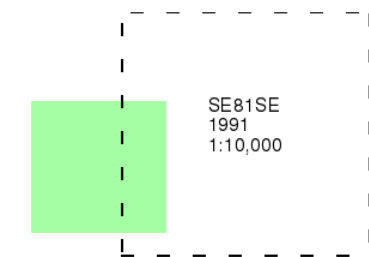

Historical Map - Slice B

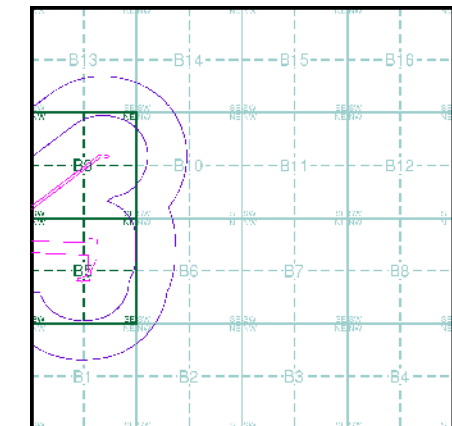

Order Details

Order Number: 242986885_1_1
Customer Ref: 60625943
National Grid Reference: 483610, 411850
Slice: B
Site Area (Ha): 68.12
Search Buffer (m): 500

Site Details

Keabby



Tel: 0844 844 9952
Fax: 0844 844 9951
Web: www.envirocheck.co.uk

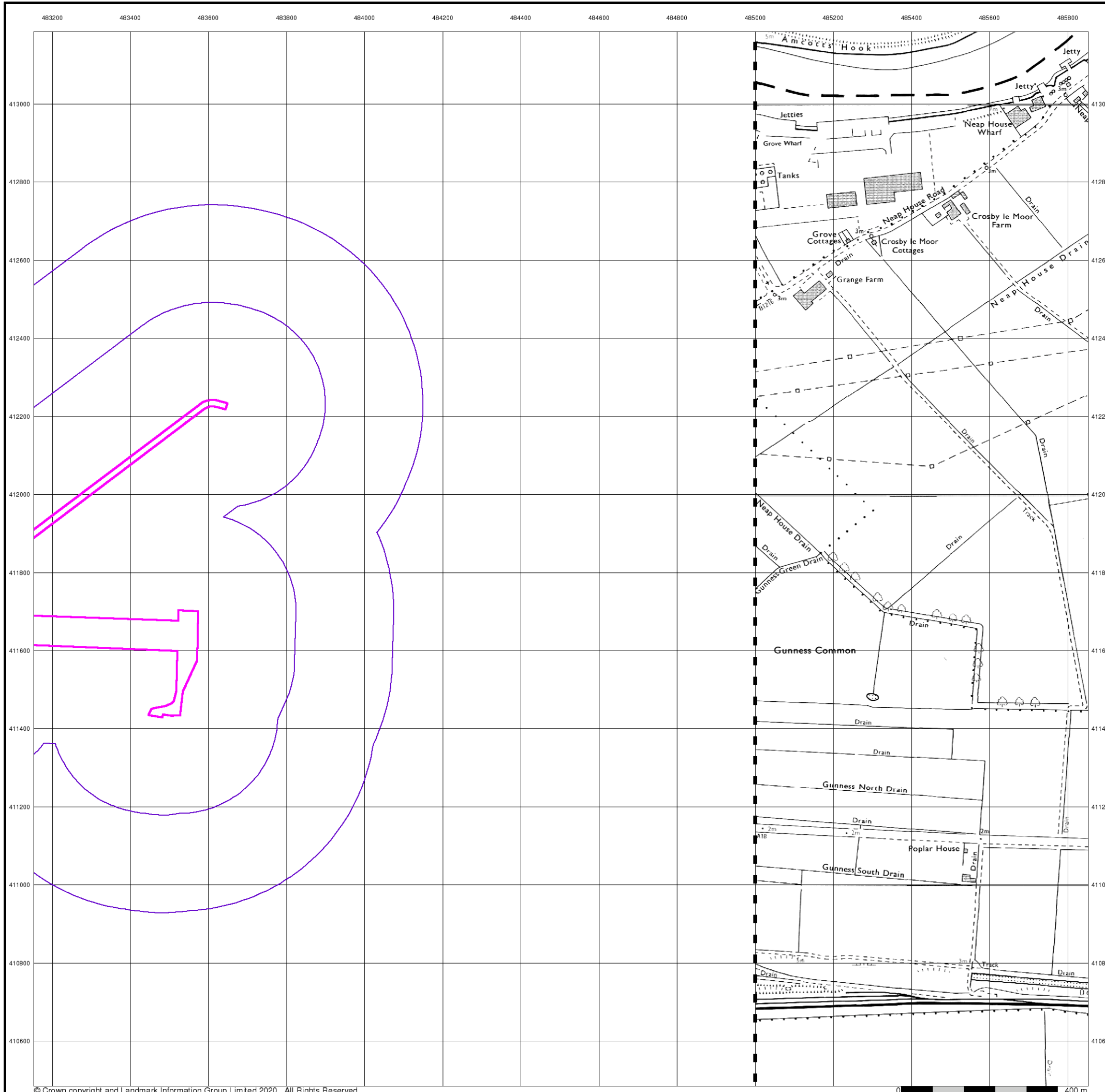



10k Raster Mapping

Published 2000

Source map scale - 1:10,000

The historical maps shown were produced from the Ordnance Survey's 1:10,000 colour raster mapping. These maps are derived from Landplan which replaced the old 1:10,000 maps originally published in 1970. The data is highly detailed showing buildings, fences and field boundaries as well as all roads, tracks and paths. Road names are also included together with the relevant road number and classification. Boundary information depiction includes county, unitary authority, district, civil parish and constituency.

Map Name(s) and Date(s)

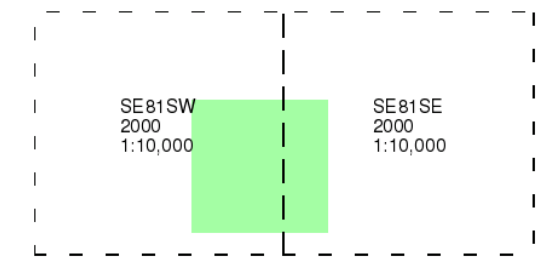

Historical Map - Slice B

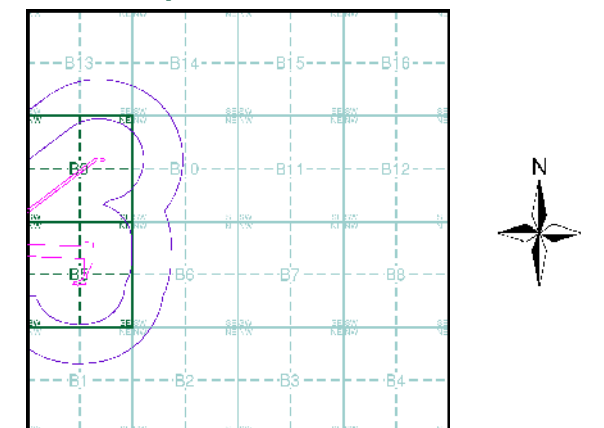

Order Details

Order Number: 242986885_1_1
Customer Ref: 60625943
National Grid Reference: 483610, 411850
Slice: B
Site Area (Ha): 68.12
Search Buffer (m): 500

Site Details

Keadby



Tel: 0844 844 9952
Fax: 0844 844 9951
Web: www.envirocheck.co.uk

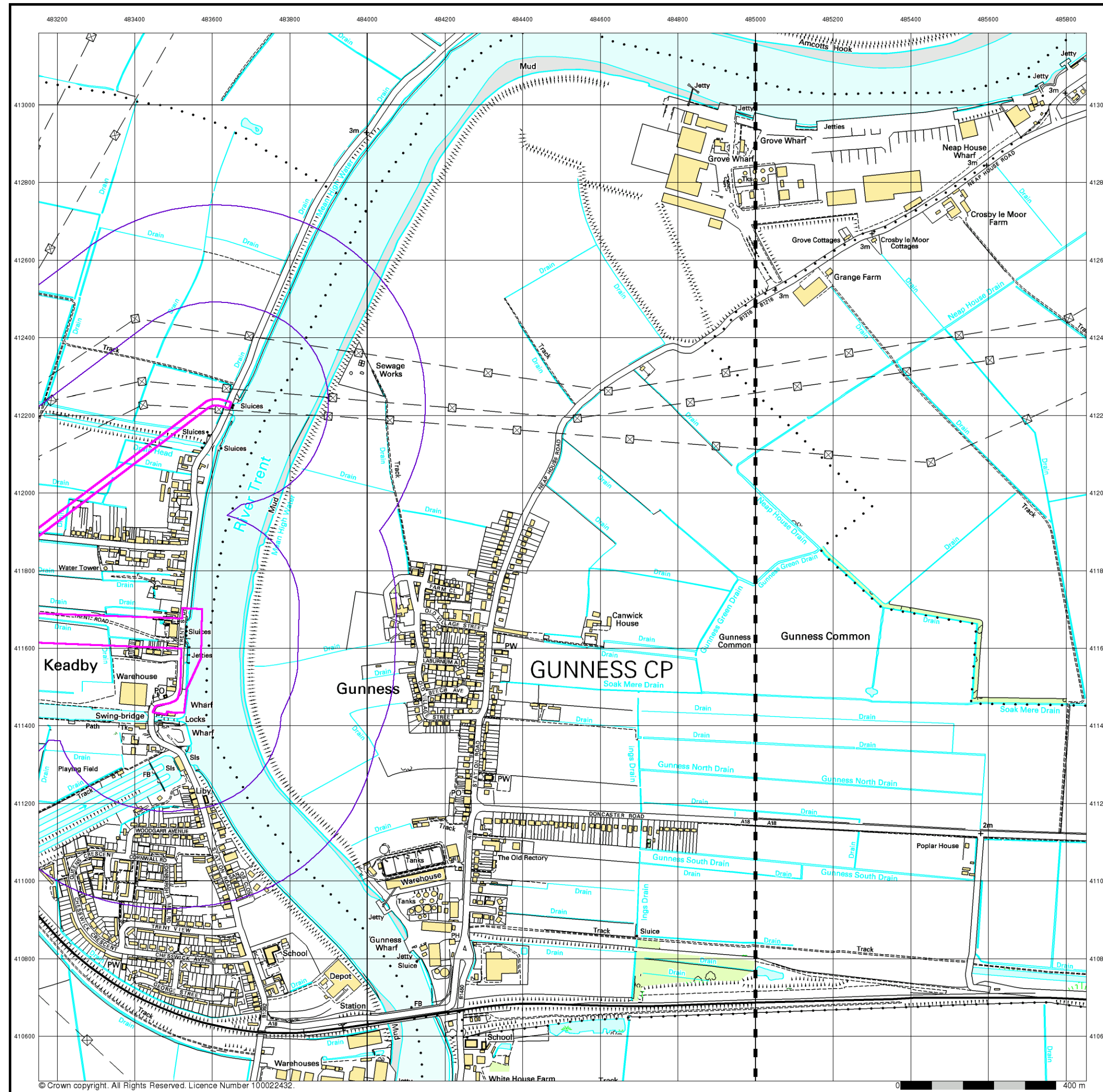

© Crown copyright. All Rights Reserved. Licence Number 100022432.



10k Raster Mapping

Published 2006

Source map scale - 1:10,000

The historical maps shown were produced from the Ordnance Survey's 1:10,000 colour raster mapping. These maps are derived from Landplan which replaced the old 1:10,000 maps originally published in 1970. The data is highly detailed showing buildings, fences and field boundaries as well as all roads, tracks and paths. Road names are also included together with the relevant road number and classification. Boundary information depiction includes county, unitary authority, district, civil parish and constituency.

Map Name(s) and Date(s)

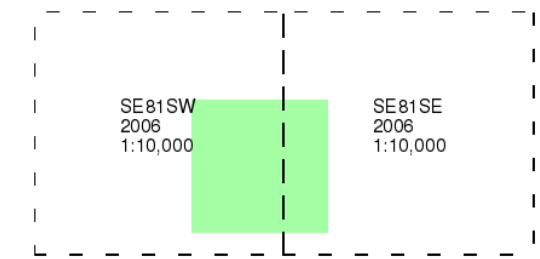

Historical Map - Slice B

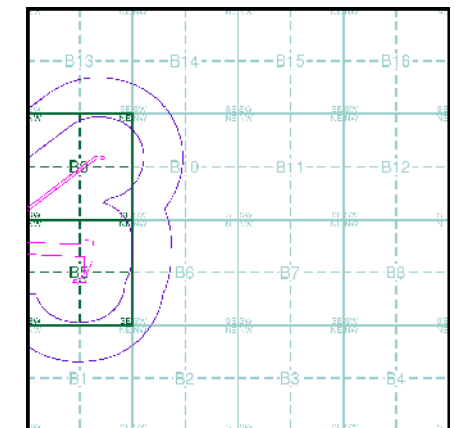

Order Details

Order Number: 242986885_1_1
 Customer Ref: 60625943
 National Grid Reference: 483610, 411850
 Slice: B
 Site Area (Ha): 68.12
 Search Buffer (m): 500

Site Details

Keadby



Tel: 0844 844 9952
 Fax: 0844 844 9951
 Web: www.envirocheck.co.uk

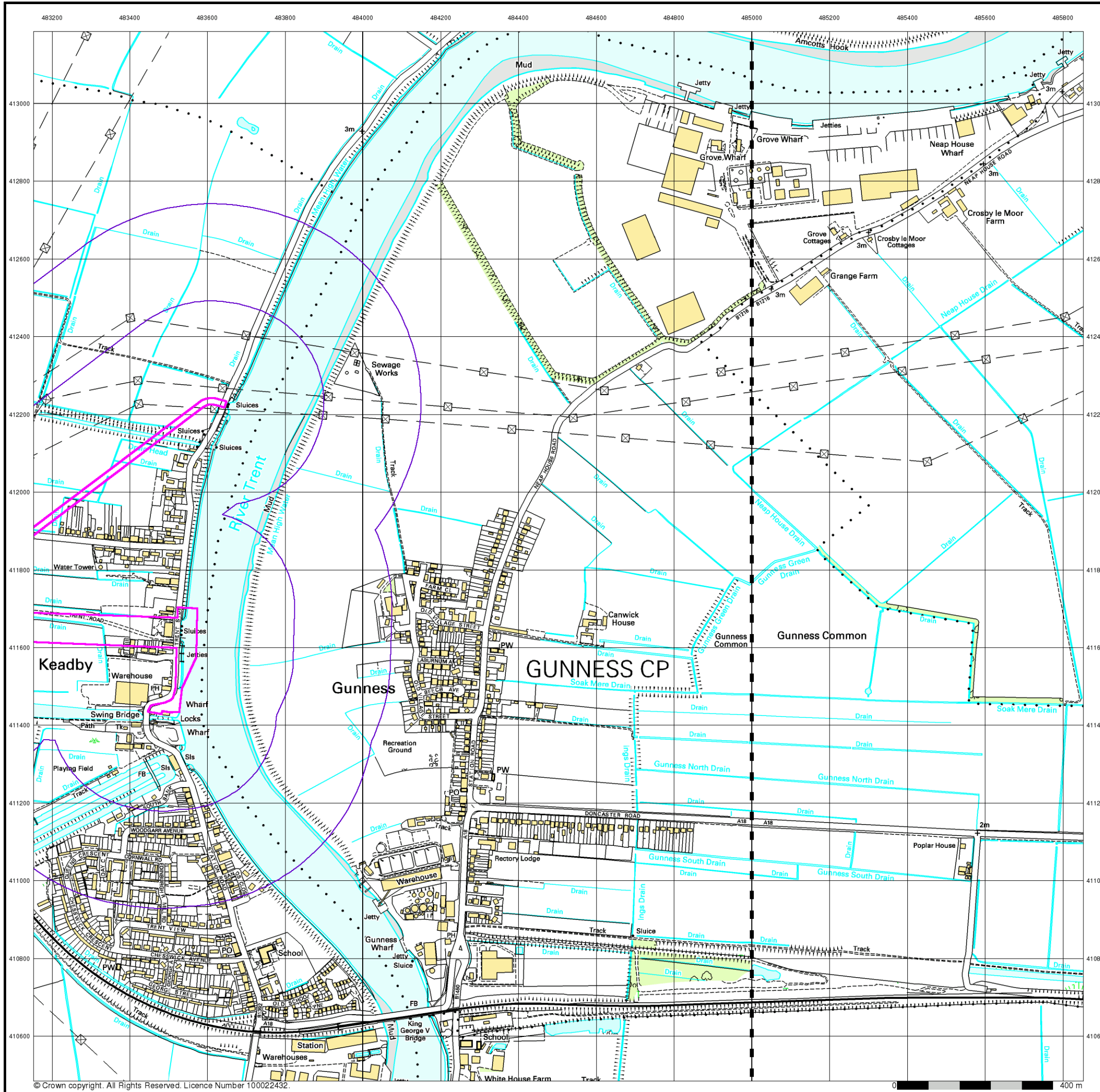



VectorMap Local

Published 2020

Source map scale - 1:10,000

VectorMap Local (Raster) is Ordnance Survey's highest detailed 'backdrop' mapping product. These maps are produced from OS's VectorMap Local, a simple vector dataset at a nominal scale of 1:10,000, covering the whole of Great Britain, that has been designed for creating graphical mapping. OS VectorMap Local is derived from large-scale information surveyed at 1:1250 scale (covering major towns and cities), 1:2500 scale (smaller towns, villages and developed rural areas), and 1:10 000 scale (mountain, moorland and river estuary areas).

Map Name(s) and Date(s)

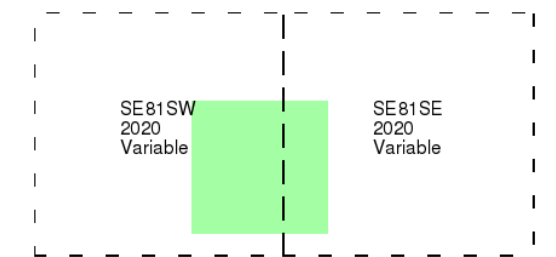

Historical Map - Slice B

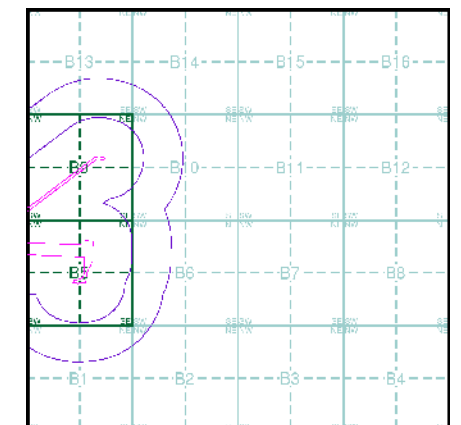

Order Details

Order Number: 242986885_1_1
Customer Ref: 60625943
National Grid Reference: 483610, 411850
Slice: B
Site Area (Ha): 68.12
Search Buffer (m): 500

Site Details

Keadby



Tel: 0844 844 9952
Fax: 0844 844 9951
Web: www.envirocheck.co.uk

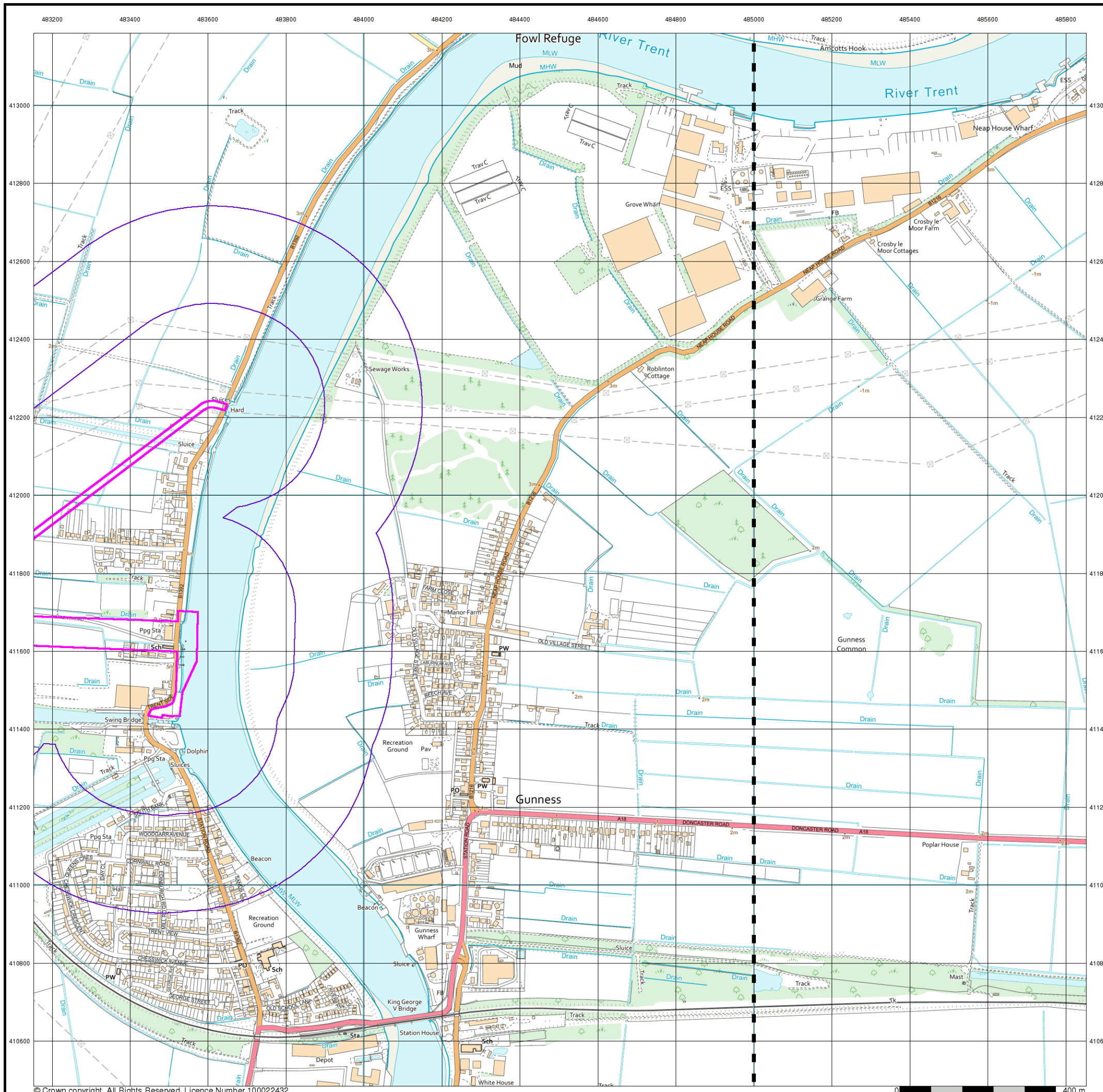

Historical Mapping Legends

Ordnance Survey County Series and Ordnance Survey Plan 1:2,500

Quarry **Gravel Pit** **Sand Pit**
Clay Pit **Shingle** **Refuse Heap**
Sloping Masonry **Flat Rock**
Marsh **Reeds** **Osiers**
Rough Pasture **Furze** **Wood**
Mixed Wood **Brushwood** **Orchard**
Fir **Ford** **Stepping Stones**
Ferry **Waterfall** **Lock**
Trig. Station **Altitude at Trig. Station**
B.M. 325.9 **Bench Mark** **Surface Level**
Arrow denotes flow of water **Antiquities (site of)**
Cutting **Embankment**
Railway crossing Road **Level Crossing** **Road crossing Railway**
Railway crossing River or Canal **Road over single stream** **Road over River or Canal**
County Boundary (Geographical)
County & Civil Parish Boundary
Administrative County & Civil Parish Boundary
County Borough Boundary (England)
County Burgh Boundary (Scotland)
Co. Boro. Bdy.
Co. Burgh Bdy.
BP BS Boundary Post or Stone **P.C.B** Police Call Box
B.R. Bridle Road **P** Pump
E.P Electricity Pylon **S.P** Signal Post
F.B. Foot Bridge **SL** Sluice
F.P. Foot Path **Sp.** Spring
G.P Guide Post or Board **T.C.B** Telephone Call Box
M.S Mile Stone **Tr.** Trough
M.P M.R Mooring Post or Ring **W** Well

Ordnance Survey Plan, Additional SIMs and Supply of Unpublished Survey Information 1:2,500 and 1:1,250

Inactive Quarry, Chalk Pit or Clay Pit **Active Quarry, Chalk Pit or Clay Pit**
Rock **Boulders**
Cliff **Slopes** **Top**
Roofed Building **Glazed Roof Building**
Sloping Masonry **Archway**
Non-Coniferous Tree (surveyed) **Coniferous Tree (surveyed)**
Non-Coniferous Trees (not surveyed) **Coniferous Trees (not surveyed)**
Orchard Tree **Scrub** **Bracken**
Coppice, Osier **Reeds** **Marsh, Saltings**
Rough Grassland **Heath** **Culvert**
Direction of water flow **Bench Mark** **Antiquity (site of)**
Cave Entrance **Triangulation Station** **Electricity Pylon**
Electricity Transmission Line
County Boundary (Geographical)
County & Civil Parish Boundary
Civil Parish Boundary
Admin. County or County Bor. Boundary
London Borough Boundary
Symbol marking point where boundary mereing changes
BH Beer House **P** Pillar, Pole or Post
BP, BS Boundary Post or Stone **PO** Post Office
Cn, C Capstan, Crane **PC** Public Convenience
Chy Chimney **PH** Public House
D Fn Drinking Fountain **Pp** Pump
EI P Electricity Pillar or Post **SB, S Br** Signal Box or Bridge
FAP Fire Alarm Pillar **SP, SL** Signal Post or Light
FB Foot Bridge **Spr** Spring
GP Guide Post **Tk** Tank or Track
H Hydrant or Hydraulic **TCB** Telephone Call Box
LC Level Crossing **TCP** Telephone Call Post
MH Manhole **Tr** Trough
MP Mile Post or Mooring Post **Wr Pt, Wr T** Water Point, Water Tap
MS Mile Stone **W** Well
NTL Normal Tidal Limit **Wd Pp** Wind Pump

Large-Scale National Grid Data 1:2,500 and 1:1,250

Cliff **Slopes** **Top**
Rock **Rock (scattered)**
Boulders **Boulders (scattered)**
Positioned Boulder **Scree**
Non-Coniferous Tree (surveyed) **Coniferous Tree (surveyed)**
Non-Coniferous Trees (not surveyed) **Coniferous Trees (not surveyed)**
Orchard Tree **Scrub** **Bracken**
Coppice, Osier **Reeds** **Marsh, Saltings**
Rough Grassland **Heath** **Culvert**
Direction of water flow **Triangulation Station** **Antiquity (site of)**
Electricity Transmission Line **Electricity Pylon**
B.M. 231.60m Bench Mark **Buildings with Building Seed**
Roofed Building **Glazed Roof Building**
Civil parish/community boundary
District boundary
County boundary
Boundary post/stone
Boundary mereing symbol (note: these always appear in opposed pairs or groups of three)
Bks Barracks **P** Pillar, Pole or Post
Bty Battery **PO** Post Office
Cemy Cemetery **PC** Public Convenience
Chy Chimney **Pp** Pump
Cis Cistern **Ppg Sta** Pumping Station
Dismtd Rly Dismantled Railway **PW** Place of Worship
EI Gen Sta Electricity Generating Station **Sewage Ppg Sta** Sewage Pumping Station
EI P Electricity Pole, Pillar **SB, S Br** Signal Box or Bridge
EI Sub Sta Electricity Sub Station **SP, SL** Signal Post or Light
FB Filter Bed **Spr** Spring
Fn / D Fn Fountain / Drinking Ftn. **Tk** Tank or Track
Gas Gov Gas Valve Compound **Tr** Trough
GVC Gas Governor **Wd Pp** Wind Pump
GP Guide Post **Wr Pt, Wr T** Water Point, Water Tap
MH Manhole **Wks** Works (building or area)
MP, MS Mile Post or Mile Stone **W** Well



Historical Mapping & Photography included:

Mapping Type	Scale	Date	Pg
Lincolnshire	1:2,500	1887	2
Lincolnshire	1:2,500	1907	3
Ordnance Survey Plan	1:2,500	1967	4
Additional SIMs	1:2,500	1982	5
Large-Scale National Grid Data	1:2,500	1994	6
Historical Aerial Photography	1:2,500	1999	7

Historical Map - Segment B5

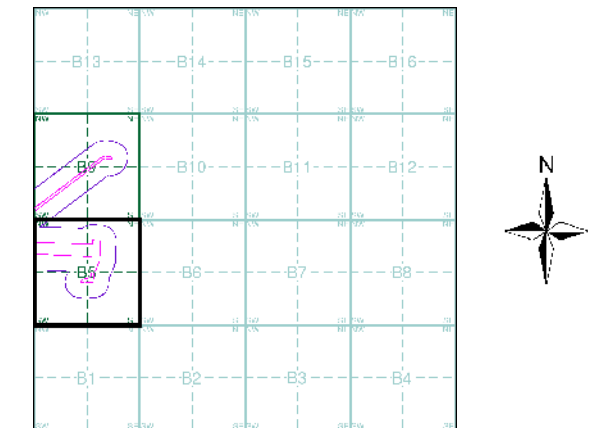

Order Details

Order Number: 242986885_1_1
 Customer Ref: 60625943
 National Grid Reference: 483610, 411850
 Slice: B
 Site Area (Ha): 68.12
 Search Buffer (m): 100

Site Details

Keaddy



Tel: 0844 844 9952
 Fax: 0844 844 9951
 Web: www.envirocheck.co.uk



Lincolnshire

Published 1887

Source map scale - 1:2,500

The historical maps shown were reproduced from maps predominantly held at the scale adopted for England, Wales and Scotland in the 1840's. In 1854 the 1:2,500 scale was adopted for mapping urban areas and by 1896 it covered the whole of what were considered to be the cultivated parts of Great Britain. The published date given below is often some years later than the surveyed date. Before 1938, all OS maps were based on the Cassini Projection, with independent surveys of a single county or group of counties, giving rise to significant inaccuracies in outlying areas.

Map Name(s) and Date(s)

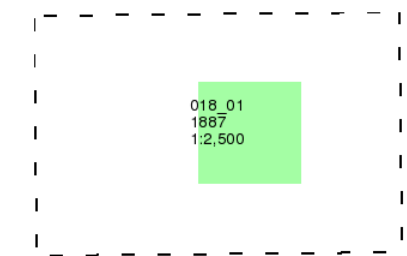

Historical Map - Segment B5

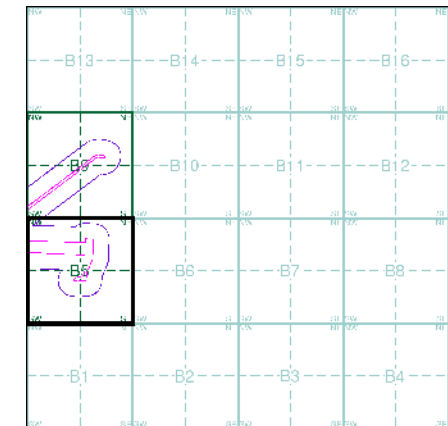

Order Details

Order Number: 242986885_1_1
Customer Ref: 60625943
National Grid Reference: 483610, 411850
Slice: B
Site Area (Ha): 68.12
Search Buffer (m): 100

Site Details

Keadbby



Tel: 0844 844 9952
Fax: 0844 844 9951
Web: www.envirocheck.co.uk

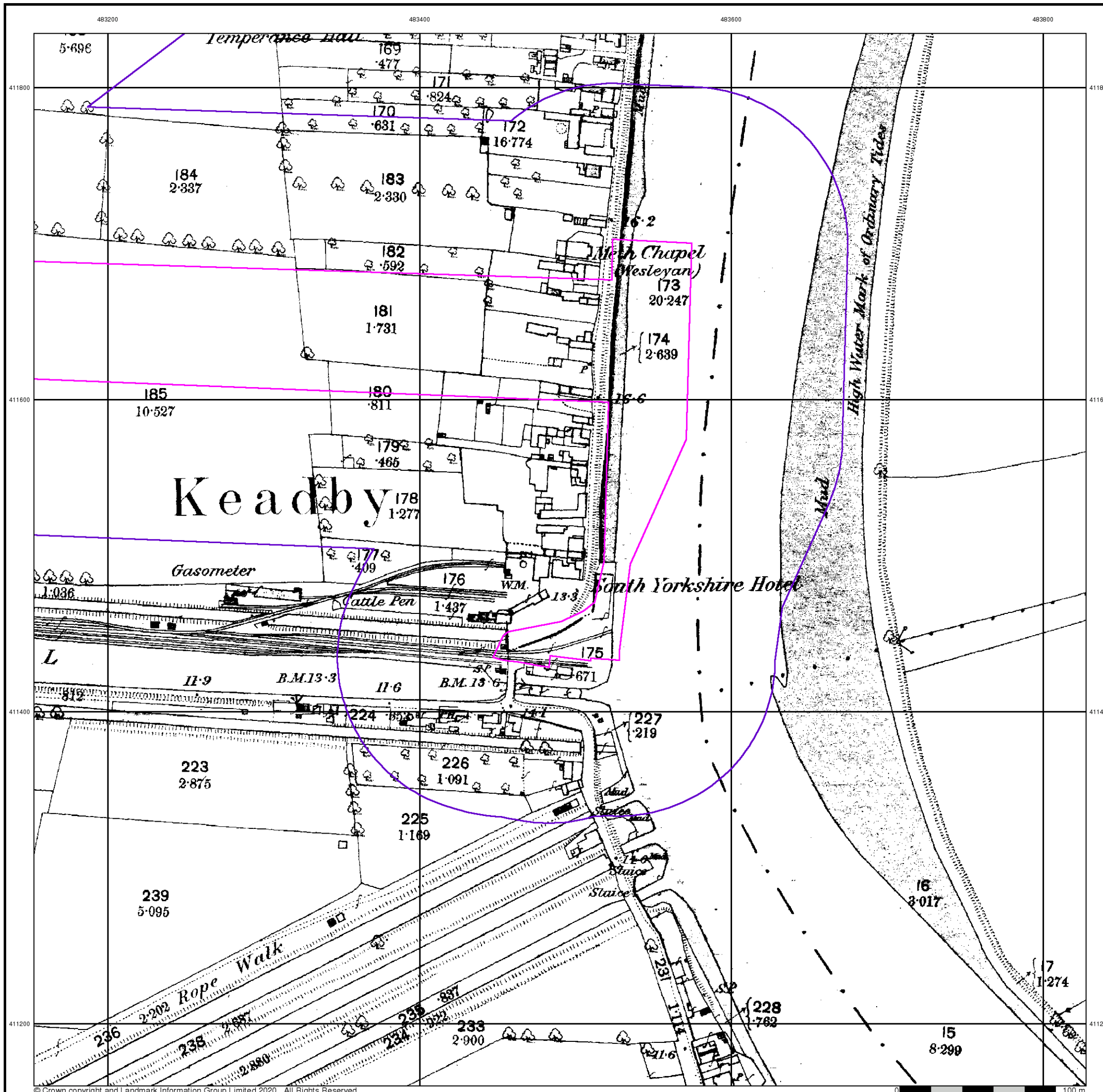



Lincolnshire

Published 1907

Source map scale - 1:2,500

The historical maps shown were reproduced from maps predominantly held at the scale adopted for England, Wales and Scotland in the 1840's. In 1854 the 1:2,500 scale was adopted for mapping urban areas and by 1896 it covered the whole of what were considered to be the cultivated parts of Great Britain. The published date given below is often some years later than the surveyed date. Before 1938, all OS maps were based on the Cassini Projection, with independent surveys of a single county or group of counties, giving rise to significant inaccuracies in outlying areas.

Map Name(s) and Date(s)

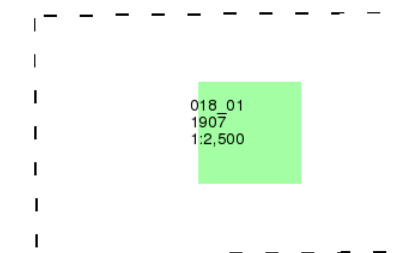

Historical Map - Segment B5

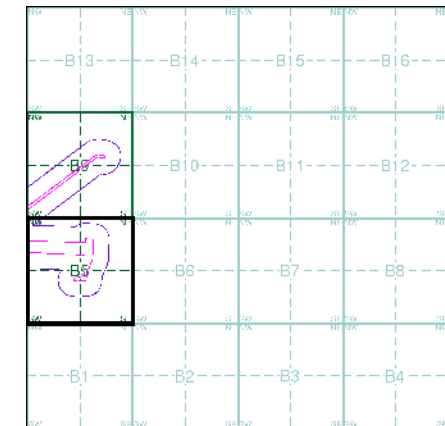

Order Details

Order Number: 242986885_1_1
Customer Ref: 60625943
National Grid Reference: 483610, 411850
Slice: B
Site Area (Ha): 68.12
Search Buffer (m): 100

Site Details

Keadby



Tel: 0844 844 9952
Fax: 0844 844 9951
Web: www.envirocheck.co.uk

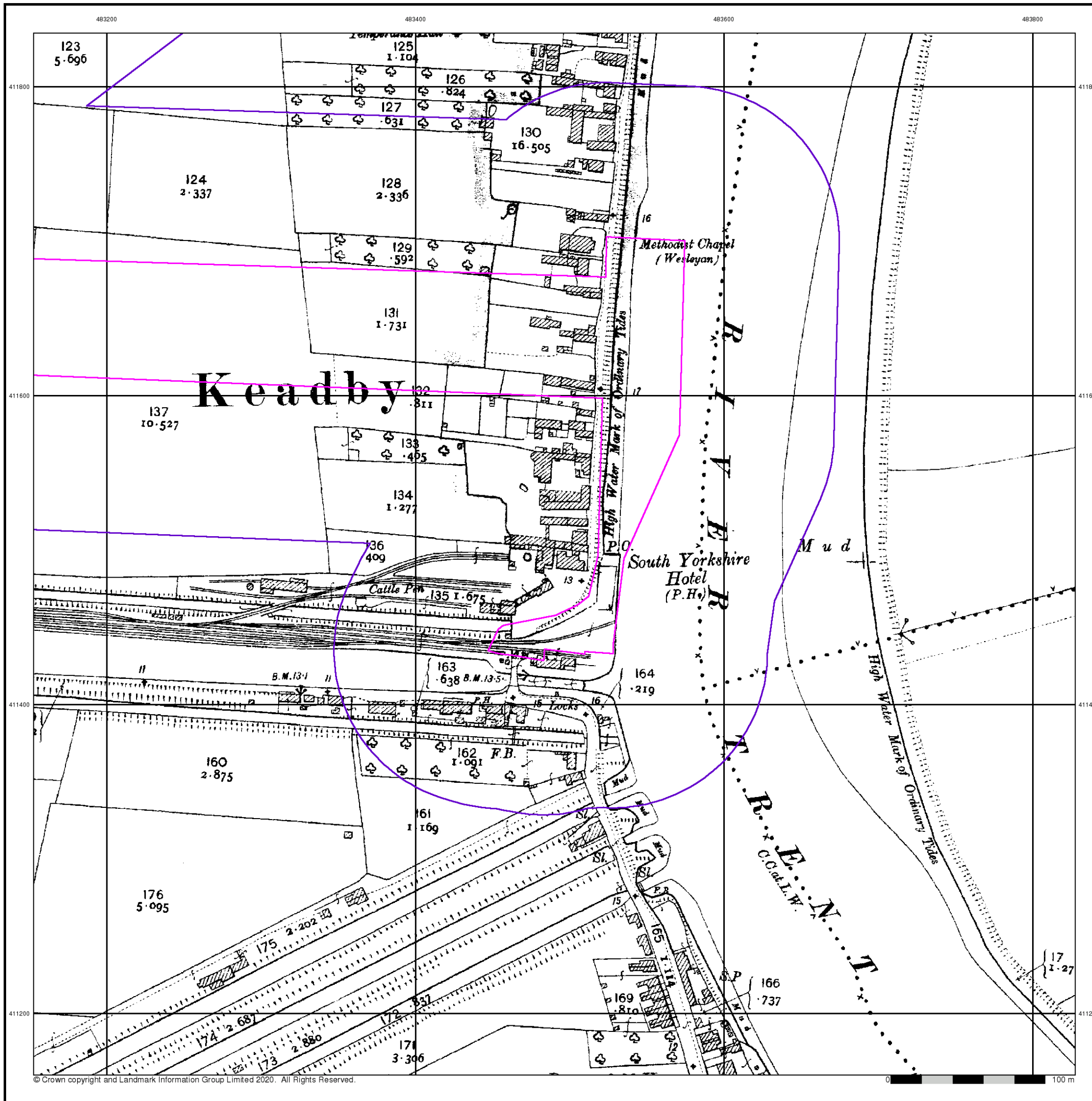



Ordnance Survey Plan

Published 1967

Source map scale - 1:2,500

The historical maps shown were reproduced from maps predominantly held at the scale adopted for England, Wales and Scotland in the 1840's. In 1854 the 1:2,500 scale was adopted for mapping urban areas and by 1896 it covered the whole of what were considered to be the cultivated parts of Great Britain. The published date given below is often some years later than the surveyed date. Before 1938, all OS maps were based on the Cassini Projection, with independent surveys of a single county or group of counties, giving rise to significant inaccuracies in outlying areas.

Map Name(s) and Date(s)

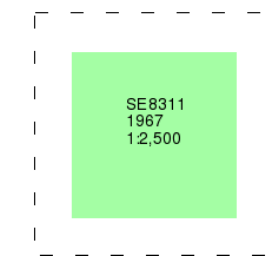

Historical Map - Segment B5

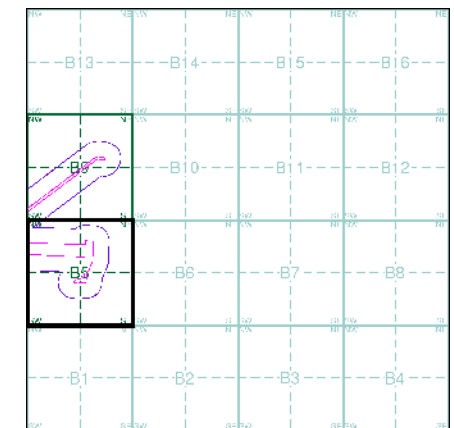

Order Details

Order Number:	242986885_1_1
Customer Ref:	60625943
National Grid Reference:	483610, 411850
Slice:	B
Site Area (Ha):	68.12
Search Buffer (m):	100

Site Details

Keadby



Tel:	0844 844 9952
Fax:	0844 844 9951
Web:	www.envirocheck.co.uk

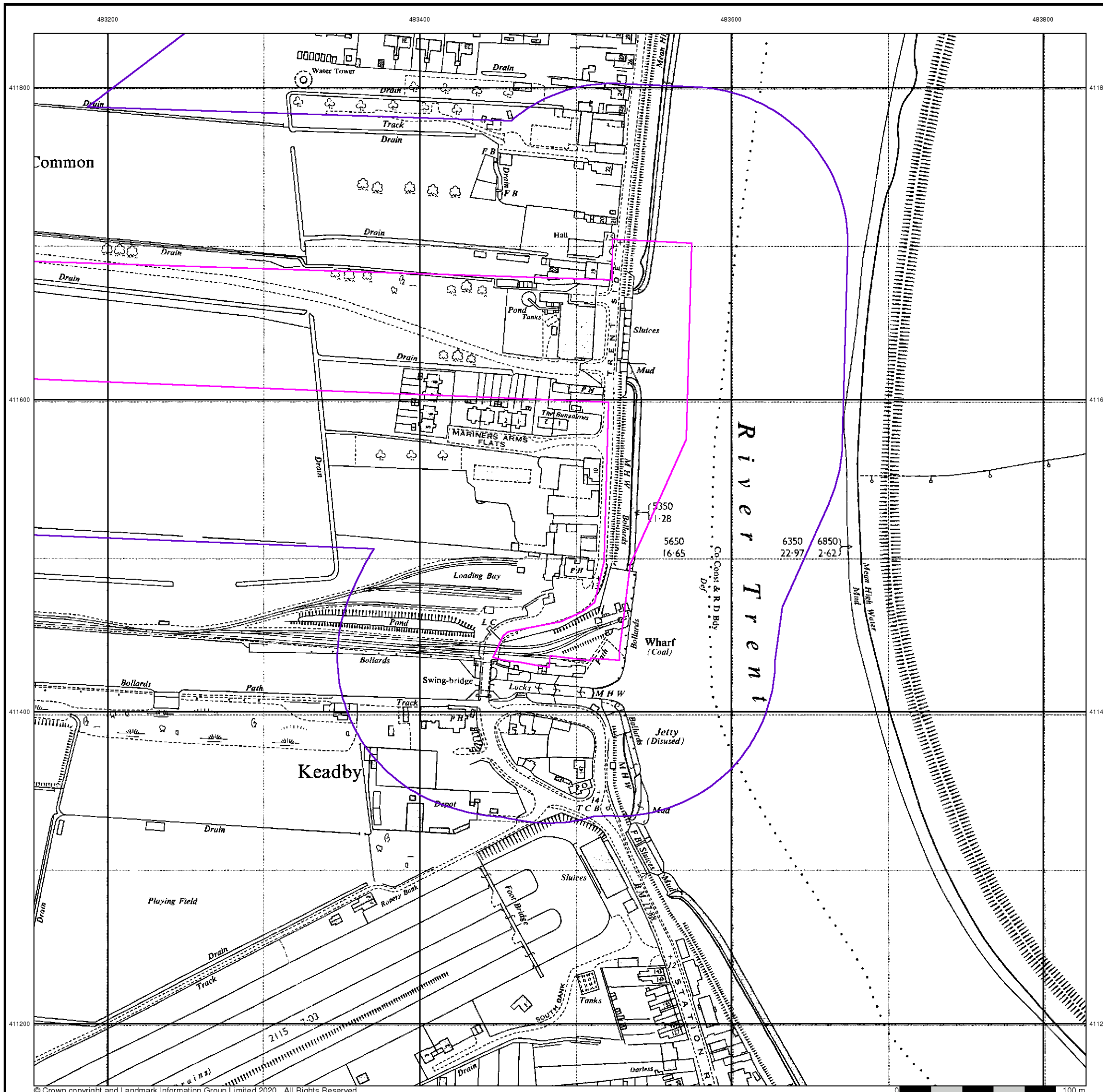



Additional SIMs

Published 1982

Source map scale - 1:2,500

The SIM cards (Ordnance Survey's 'Survey of Information on Microfilm') are further, minor editions of mapping which were produced and published in between the main editions as an area was updated. They date from 1947 to 1994, and contain detailed information on buildings, roads and land-use. These maps were produced at both 1:2,500 and 1:1,250 scales.

Map Name(s) and Date(s)

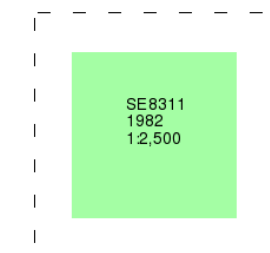

Historical Map - Segment B5

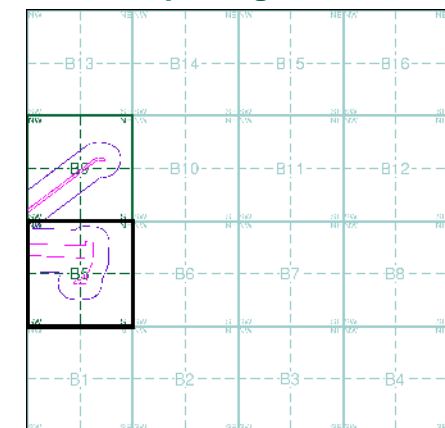

Order Details

Order Number:	242986885_1_1
Customer Ref:	60625943
National Grid Reference:	483610, 411850
Slice:	B
Site Area (Ha):	68.12
Search Buffer (m):	100

Site Details

Keadby



Tel:	0844 844 9952
Fax:	0844 844 9951
Web:	www.envirocheck.co.uk

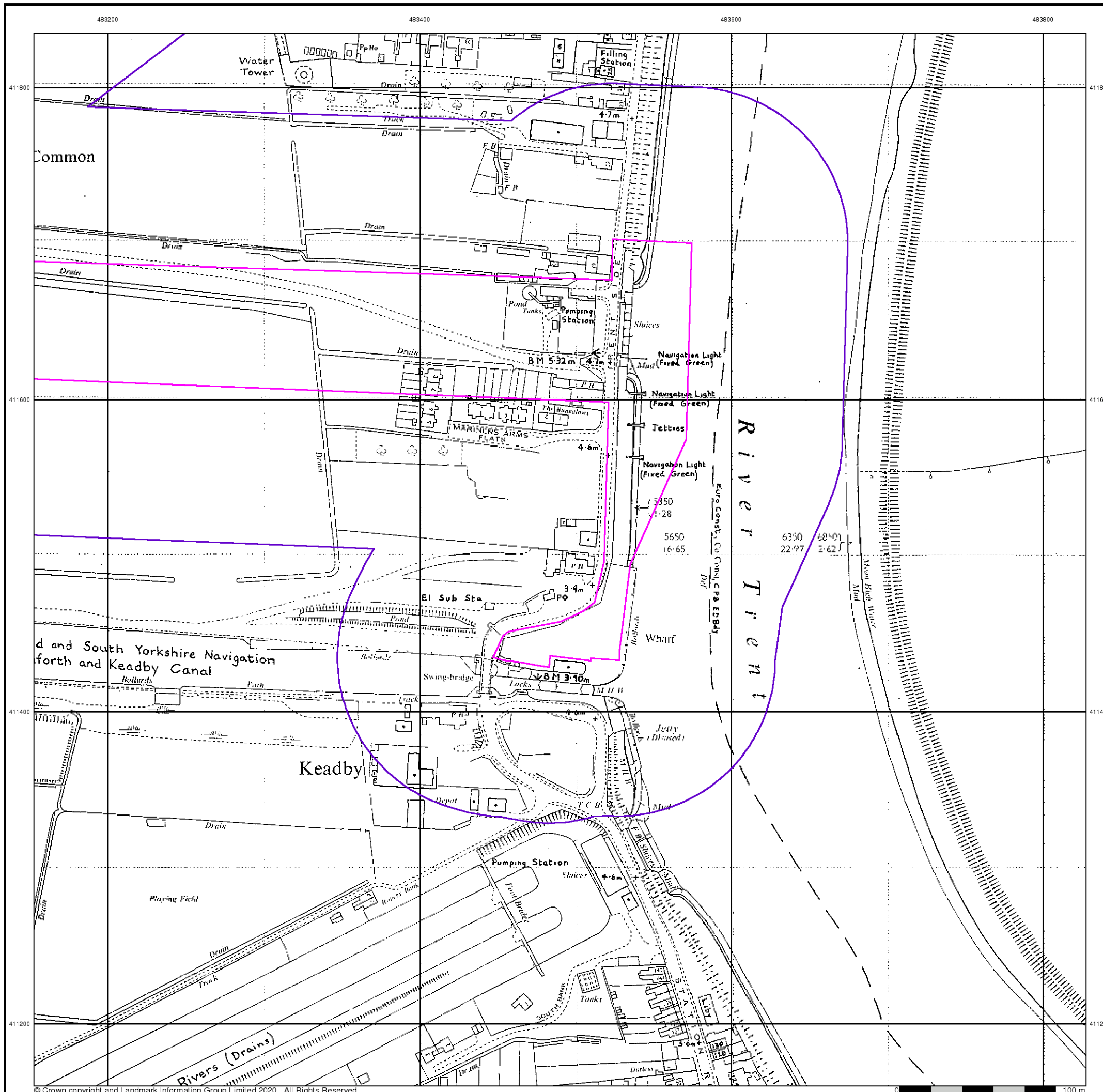



Large-Scale National Grid Data

Published 1994

Source map scale - 1:2,500

'Large Scale National Grid Data' superseded SIM cards (Ordnance Survey's 'Survey of Information on Microfilm') in 1992, and continued to be produced until 1999. These maps were the fore-runners of digital mapping and so provide detailed information on houses and roads, but tend to show less topographic features such as vegetation. These maps were produced at both 1:2,500 and 1:1,250 scales.

Map Name(s) and Date(s)

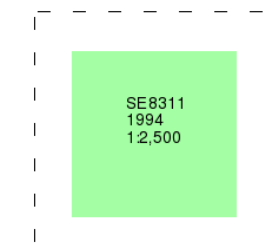

Historical Map - Segment B5

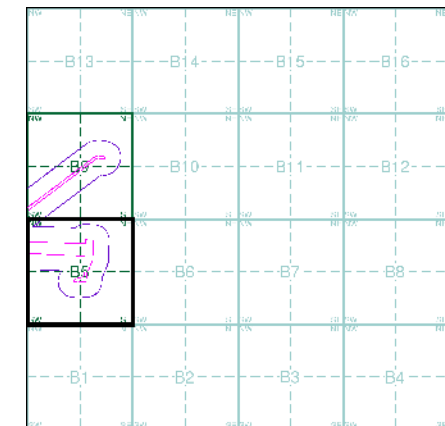

Order Details

Order Number:	242986885_1_1
Customer Ref:	60625943
National Grid Reference:	483610, 411850
Slice:	B
Site Area (Ha):	68.12
Search Buffer (m):	100

Site Details

Keadby



Tel:	0844 844 9952
Fax:	0844 844 9951
Web:	www.envirocheck.co.uk



483200

483400

483600

483800

411800

411800

411600

411600

411400

411400

411200

411200



Historical Aerial Photography

Published 1999

This aerial photography was produced by Getmapping, these vertical aerial photographs provide a seamless, full colour survey of the whole of Great Britain

Historical Aerial Photography - Segment B5

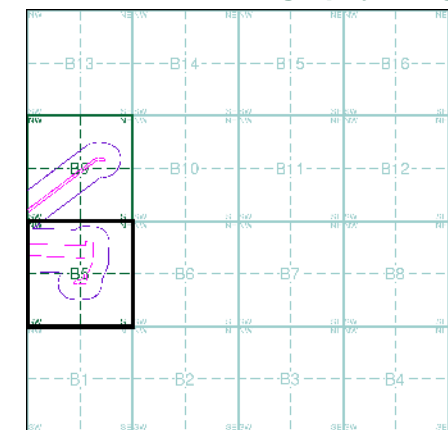

Order Details

Order Number: 242986885_1_1
 Customer Ref: 60625943
 National Grid Reference: 483610, 411850
 Slice: B
 Site Area (Ha): 68.12
 Search Buffer (m): 100

Site Details

Keadby



Tel: 0844 844 9952
 Fax: 0844 844 9951
 Web: www.envirocheck.co.uk



Historical Mapping Legends

Ordnance Survey County Series and Ordnance Survey Plan 1:2,500

Quarry **Gravel Pit** **Sand Pit**
Clay Pit **Shingle** **Refuse Heap**
Sloping Masonry **Flat Rock**

Marsh **Reeds** **Osiers**
Rough Pasture **Furze** **Wood**
Mixed Wood **Brushwood** **Orchard**

Fir **Ford** **Stepping Stones**
Ferry **Waterfall** **Lock**

Trig. Station **Altitude at Trig. Station**
B.M. 325.9 **Bench Mark** **Surface Level**
Arrow denotes flow of water **Antiquities (site of)**

Cutting **Embankment**

Railway crossing Road **Level Crossing** **Road crossing Railway**
Railway crossing River or Canal **Road over single stream** **Road over River or Canal**

County Boundary (Geographical)
County & Civil Parish Boundary
Administrative County & Civil Parish Boundary
County Borough Boundary (England)
County Burgh Boundary (Scotland)

BP, BS Boundary Post or Stone **P.C.B** Police Call Box
B.R. Bridle Road **P** Pump
E.P Electricity Pylon **S.P** Signal Post
F.B. Foot Bridge **SL** Sluice
F.P. Foot Path **Sp.** Spring
G.P Guide Post or Board **T.C.B** Telephone Call Box
M.S Mile Stone **Tr.** Trough
M.P M.R Mooring Post or Ring **W** Well

Ordnance Survey Plan, Additional SIMs and Supply of Unpublished Survey Information 1:2,500 and 1:1,250

Inactive Quarry, Chalk Pit or Clay Pit **Active Quarry, Chalk Pit or Clay Pit**
Rock **Boulders**

Roofed Building **Glazed Roof Building**
Sloping Masonry **Archway**

Non-Coniferous Tree (surveyed) **Coniferous Tree (surveyed)**
Non-Coniferous Trees (not surveyed) **Coniferous Trees (not surveyed)**

Orchard Tree **Scrub** **Bracken**
Coppice, Osier **Reeds** **Marsh, Saltings**

Rough Grassland **Heath** **Culvert**
Direction of water flow **Bench Mark** **Antiquity (site of)**
Cave Entrance **Triangulation Station** **Electricity Pylon**

Electricity Transmission Line

County Boundary (Geographical)
County & Civil Parish Boundary
Civil Parish Boundary
Admin. County or County Bor. Boundary
London Borough Boundary
Symbol marking point where boundary mereing changes

BH Beer House **P** Pillar, Pole or Post
BP, BS Boundary Post or Stone **PO** Post Office
Cn, C Capstan, Crane **PC** Public Convenience
Chy Chimney **PH** Public House
D Fn Drinking Fountain **Pp** Pump
EI P Electricity Pillar or Post **SB, S Br** Signal Box or Bridge
FAP Fire Alarm Pillar **SP, SL** Signal Post or Light
FB Foot Bridge **Spr** Spring
GP Guide Post **Tk** Tank or Track
H Hydrant or Hydraulic **TCB** Telephone Call Box
LC Level Crossing **TCP** Telephone Call Post
MH Manhole **Tr** Trough
MP Mile Post or Mooring Post **Wr Pt, Wr T** Water Point, Water Tap
MS Mile Stone **W** Well
NTL Normal Tidal Limit **Wd Pp** Wind Pump

Large-Scale National Grid Data 1:2,500 and 1:1,250

Cliff **Slopes** **Top**

Rock **Rock (scattered)**
Boulders **Boulders (scattered)**
Positioned Boulder **Scree**

Non-Coniferous Tree (surveyed) **Coniferous Tree (surveyed)**
Non-Coniferous Trees (not surveyed) **Coniferous Trees (not surveyed)**

Orchard Tree **Scrub** **Bracken**
Coppice, Osier **Reeds** **Marsh, Saltings**

Rough Grassland **Heath** **Culvert**
Direction of water flow **Triangulation Station** **Antiquity (site of)**
Electricity Transmission Line **Electricity Pylon**

Bench Mark **Buildings with Building Seed**
Roofed Building **Glazed Roof Building**

Civil parish/community boundary
District boundary
County boundary
Boundary post/stone
Boundary mereing symbol (note: these always appear in opposed pairs or groups of three)

Bks Barracks **P** Pillar, Pole or Post
Bty Battery **PO** Post Office
Cemy Cemetery **PC** Public Convenience
Chy Chimney **Pp** Pump
Cis Cistern **Ppg Sta** Pumping Station
Dismtd Rly Dismantled Railway **PW** Place of Worship
EI Gen Sta Electricity Generating Station **Sewage Ppg Sta** Sewage Pumping Station
EI P Electricity Pole, Pillar **SB, S Br** Signal Box or Bridge
EI Sub Sta Electricity Sub Station **SP, SL** Signal Post or Light
FB Filter Bed **Spr** Spring
Fn / D Fn Fountain / Drinking Ftn. **Tk** Tank or Track
Gas Gov Gas Valve Compound **Tr** Trough
GVC Gas Governor **Wd Pp** Wind Pump
GP Guide Post **Wr Pt, Wr T** Water Point, Water Tap
MH Manhole **Wks** Works (building or area)
MP, MS Mile Post or Mile Stone **W** Well



Historical Mapping & Photography included:

Mapping Type	Scale	Date	Pg
Lincolnshire	1:2,500	1886 - 1887	2
Lincolnshire	1:2,500	1907	3
Ordnance Survey Plan	1:2,500	1966 - 1967	4
Additional SIMs	1:2,500	1982	5
Large-Scale National Grid Data	1:2,500	1994	6
Large-Scale National Grid Data	1:2,500	1996	7
Historical Aerial Photography	1:2,500	1999	8

Historical Map - Segment B9

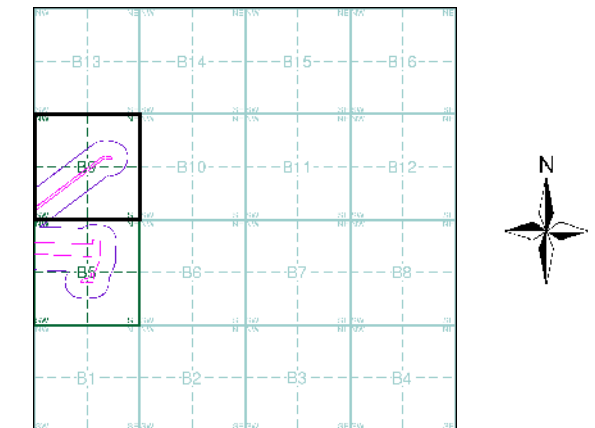

Order Details

Order Number: 242986885_1_1
 Customer Ref: 60625943
 National Grid Reference: 483610, 411850
 Slice: B
 Site Area (Ha): 68.12
 Search Buffer (m): 100

Site Details

Keaddy



Tel: 0844 844 9952
 Fax: 0844 844 9951
 Web: www.envirocheck.co.uk



Lincolnshire

Published 1886 - 1887

Source map scale - 1:2,500

The historical maps shown were reproduced from maps predominantly held at the scale adopted for England, Wales and Scotland in the 1840's. In 1854 the 1:2,500 scale was adopted for mapping urban areas and by 1896 it covered the whole of what were considered to be the cultivated parts of Great Britain. The published date given below is often some years later than the surveyed date. Before 1938, all OS maps were based on the Cassini Projection, with independent surveys of a single county or group of counties, giving rise to significant inaccuracies in outlying areas.

Map Name(s) and Date(s)

010_13
1886
1:2,500
018_01
1887
1:2,500

Historical Map - Segment B9

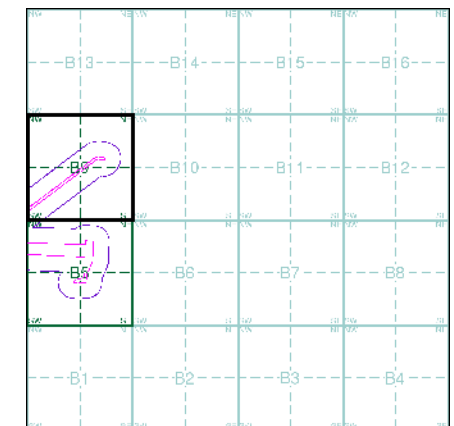

Order Details

Order Number: 242986885_1_1
Customer Ref: 60625943
National Grid Reference: 483610, 411850
Slice: B
Site Area (Ha): 68.12
Search Buffer (m): 100

Site Details

Keadby



Tel: 0844 844 9952
Fax: 0844 844 9951
Web: www.envirocheck.co.uk

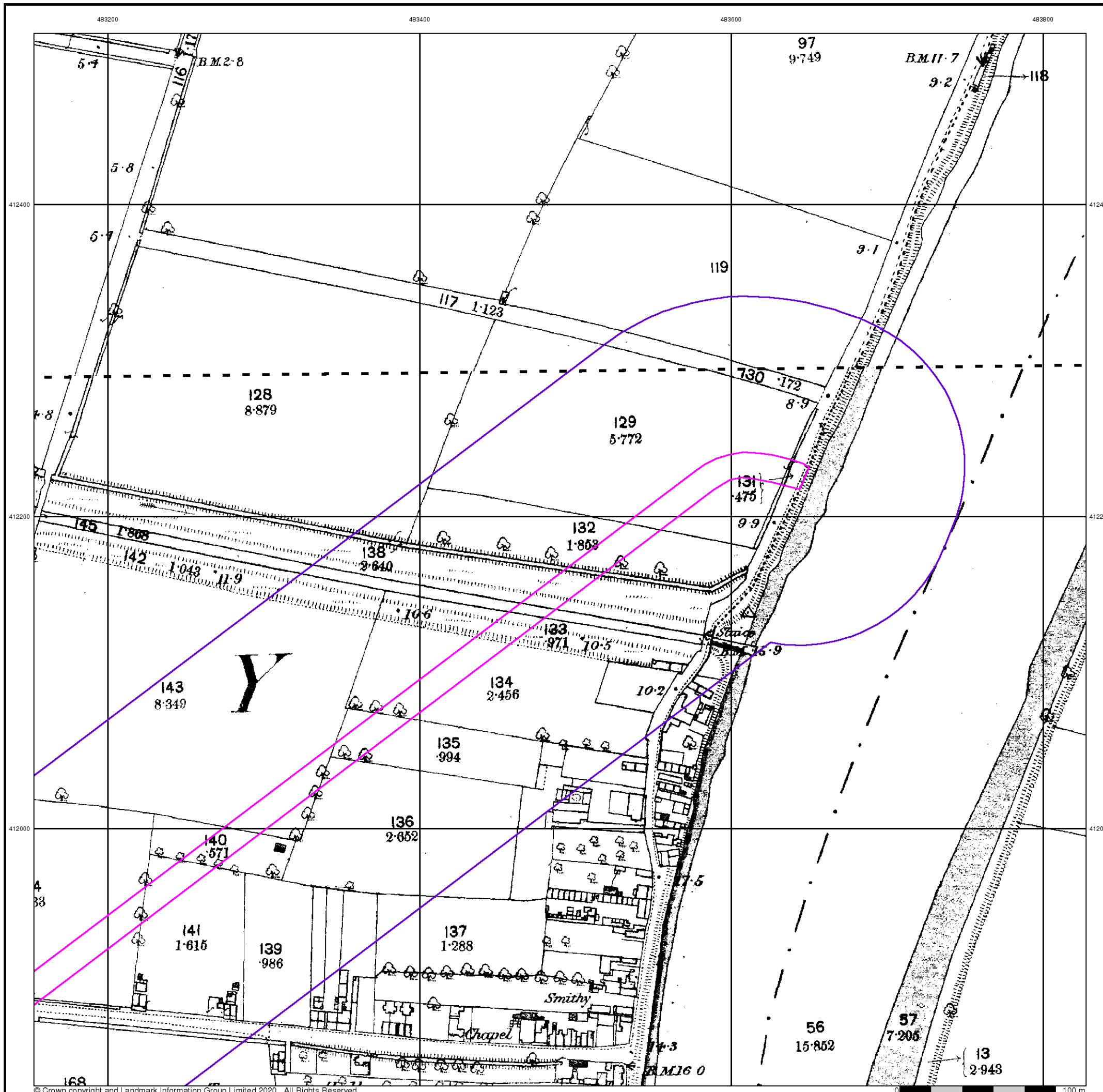



Lincolnshire

Published 1907

Source map scale - 1:2,500

The historical maps shown were reproduced from maps predominantly held at the scale adopted for England, Wales and Scotland in the 1840's. In 1854 the 1:2,500 scale was adopted for mapping urban areas and by 1896 it covered the whole of what were considered to be the cultivated parts of Great Britain. The published date given below is often some years later than the surveyed date. Before 1938, all OS maps were based on the Cassini Projection, with independent surveys of a single county or group of counties, giving rise to significant inaccuracies in outlying areas.

Map Name(s) and Date(s)

010_13
1907
1:2,500
018_01
1907
1:2,500

Historical Map - Segment B9

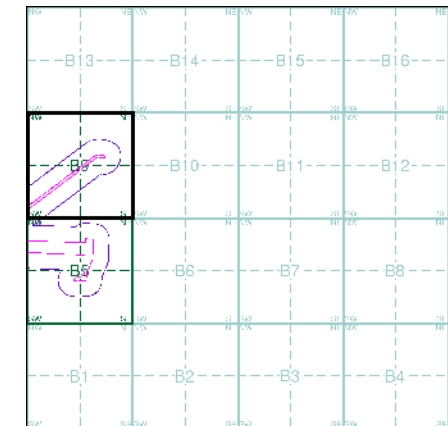

Order Details

Order Number: 242986885_1_1
Customer Ref: 60625943
National Grid Reference: 483610, 411850
Slice: B
Site Area (Ha): 68.12
Search Buffer (m): 100

Site Details

Keabby



Tel: 0844 844 9952
Fax: 0844 844 9951
Web: www.envirocheck.co.uk

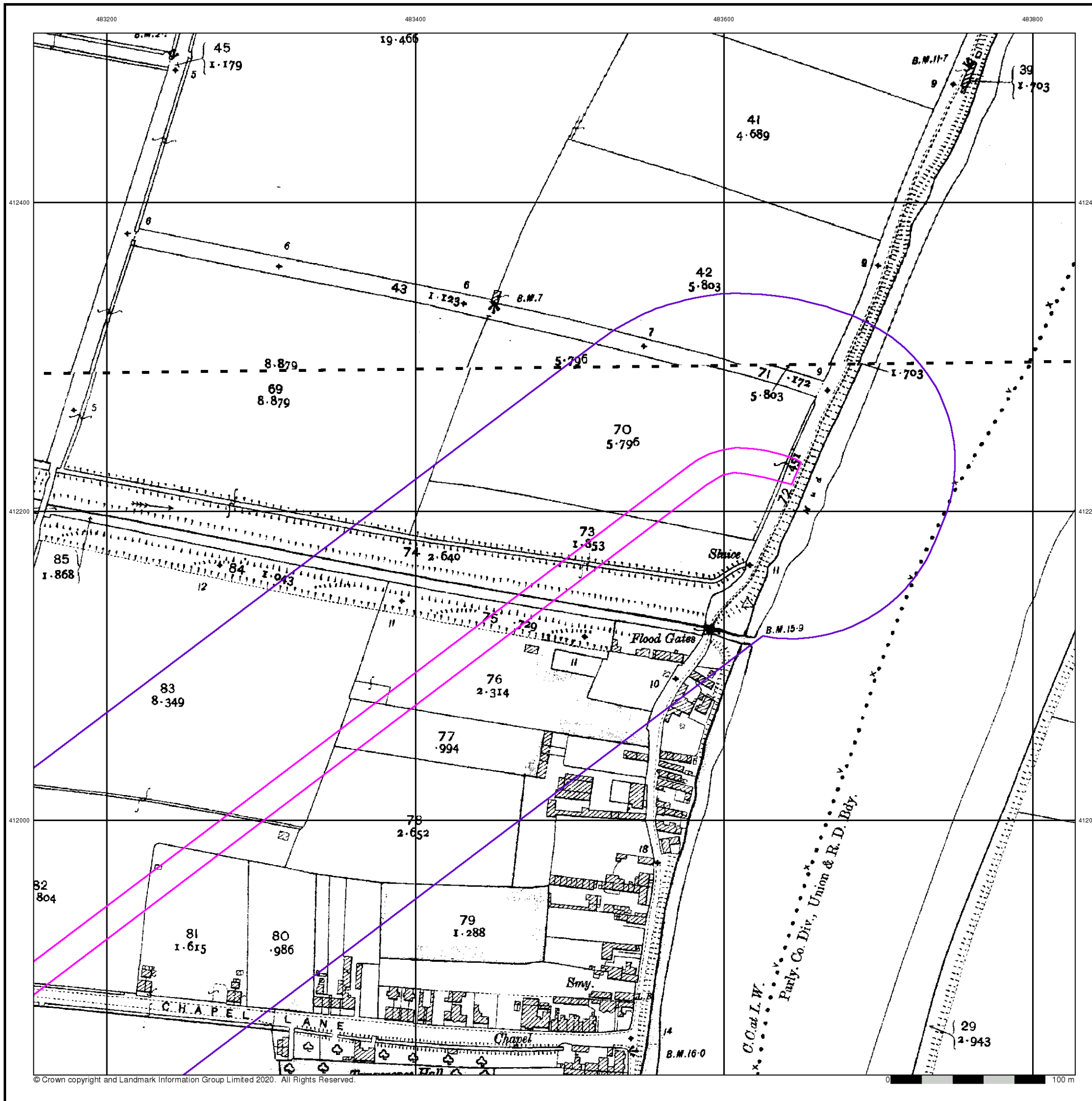



Ordnance Survey Plan Published 1966 - 1967 Source map scale - 1:2,500

The historical maps shown were reproduced from maps predominantly held at the scale adopted for England, Wales and Scotland in the 1840's. In 1854 the 1:2,500 scale was adopted for mapping urban areas and by 1896 it covered the whole of what were considered to be the cultivated parts of Great Britain. The published date given below is often some years later than the surveyed date. Before 1938, all OS maps were based on the Cassini Projection, with independent surveys of a single county or group of counties, giving rise to significant inaccuracies in outlying areas.

Map Name(s) and Date(s)

SE8312
1966
1:2,500
SE8311
1967
1:2,500

Historical Map - Segment B9

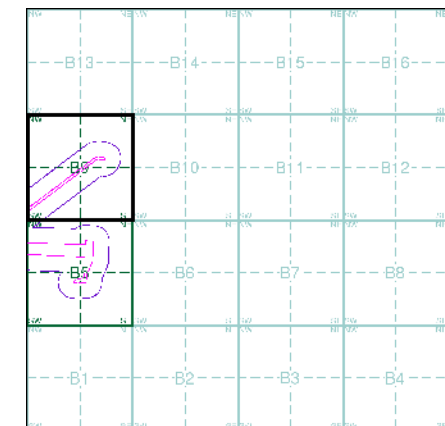

Order Details

Order Number: 242986885_1_1
Customer Ref: 60625943
National Grid Reference: 483610, 411850
Slice: B
Site Area (Ha): 68.12
Search Buffer (m): 100

Site Details

Keadby



Tel: 0844 844 9952
Fax: 0844 844 9951
Web: www.envirocheck.co.uk

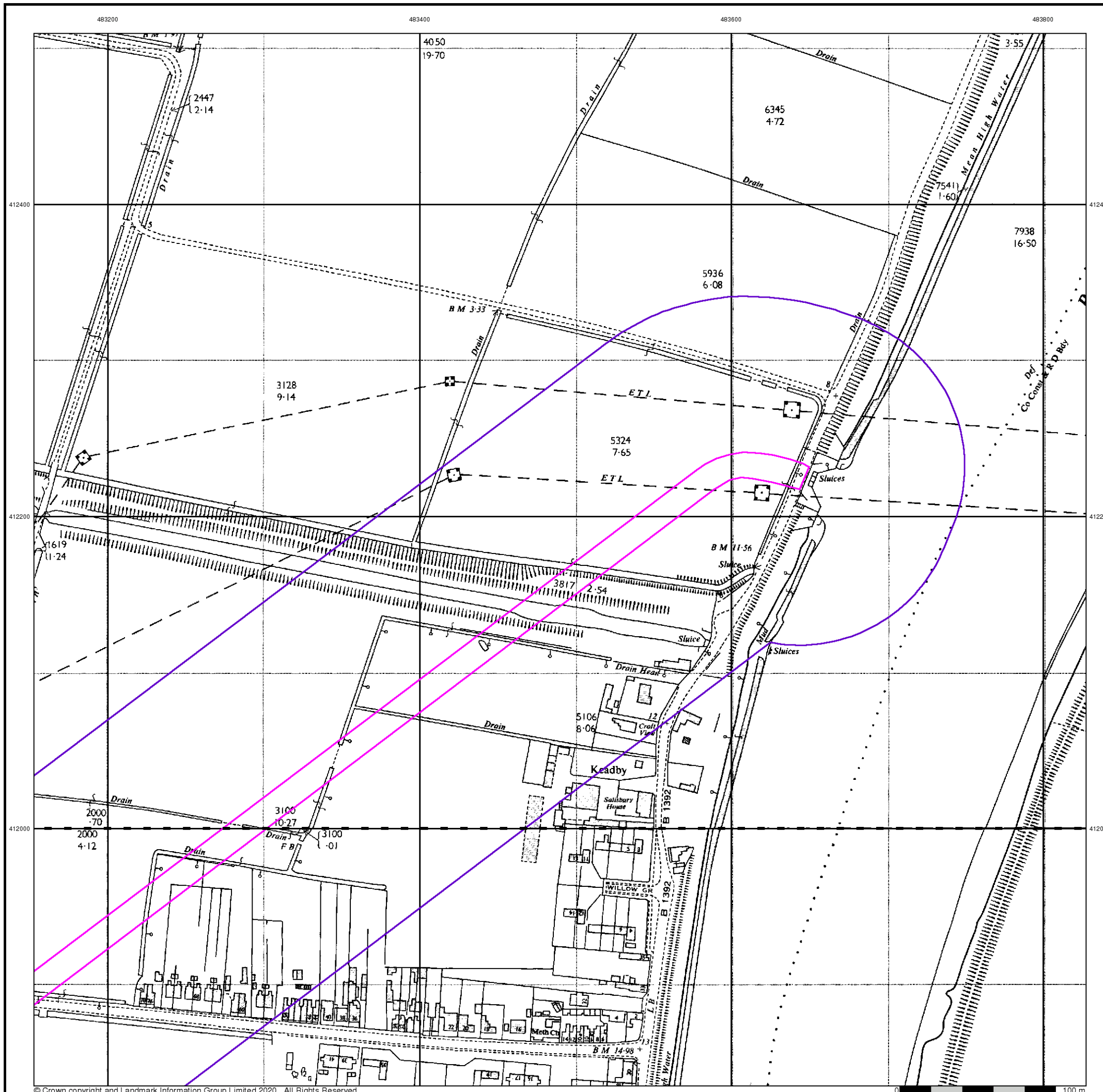



Large-Scale National Grid Data

Published 1994

Source map scale - 1:2,500

'Large Scale National Grid Data' superseded SIM cards (Ordnance Survey's 'Survey of Information on Microfilm') in 1992, and continued to be produced until 1999. These maps were the fore-runners of digital mapping and so provide detailed information on houses and roads, but tend to show less topographic features such as vegetation. These maps were produced at both 1:2,500 and 1:1,250 scales.

Map Name(s) and Date(s)

SE8312	1994	1:2,500
SE8311	1994	1:2,500

Historical Map - Segment B9

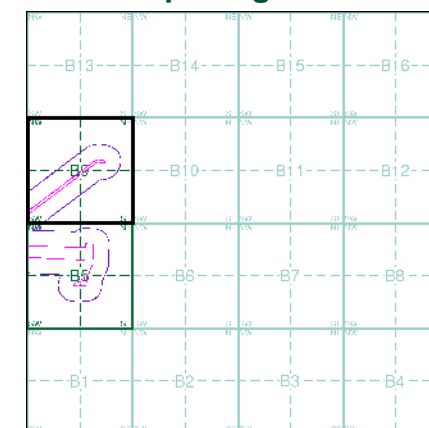

Order Details

Order Number: 242986885_1_1
Customer Ref: 60625943
National Grid Reference: 483610, 411850
Slice: B
Site Area (Ha): 68.12
Search Buffer (m): 100

Site Details

Keadby



Tel: 0844 844 9952
Fax: 0844 844 9951
Web: www.envirocheck.co.uk

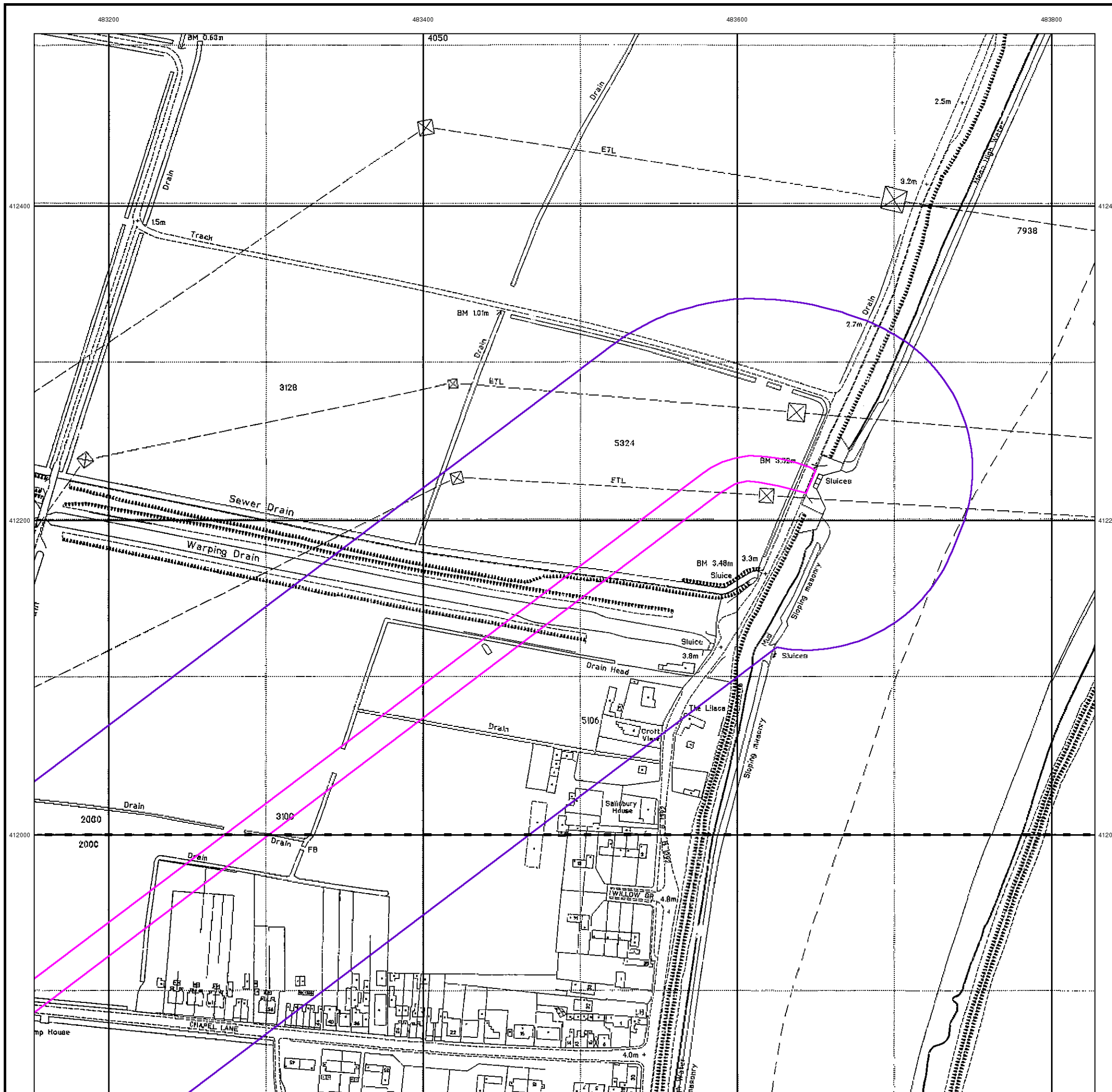



Large-Scale National Grid Data

Published 1996

Source map scale - 1:2,500

'Large Scale National Grid Data' superseded SIM cards (Ordnance Survey's 'Survey of Information on Microfilm') in 1992, and continued to be produced until 1999. These maps were the fore-runners of digital mapping and so provide detailed information on houses and roads, but tend to show less topographic features such as vegetation. These maps were produced at both 1:2,500 and 1:1,250 scales.

Map Name(s) and Date(s)

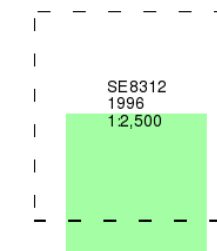

Historical Map - Segment B9

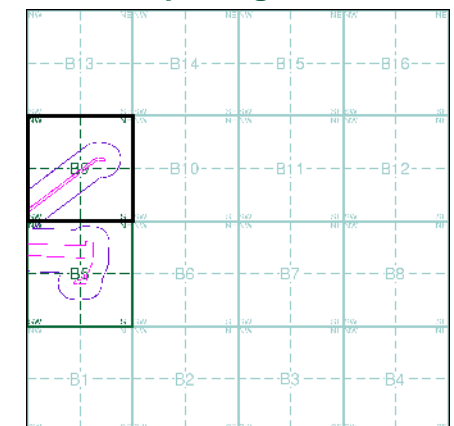

Order Details

Order Number: 242986885_1_1
Customer Ref: 60625943
National Grid Reference: 483610, 411850
Slice: B
Site Area (Ha): 68.12
Search Buffer (m): 100

Site Details

Keadby



Tel: 0844 844 9952
Fax: 0844 844 9951
Web: www.envirocheck.co.uk

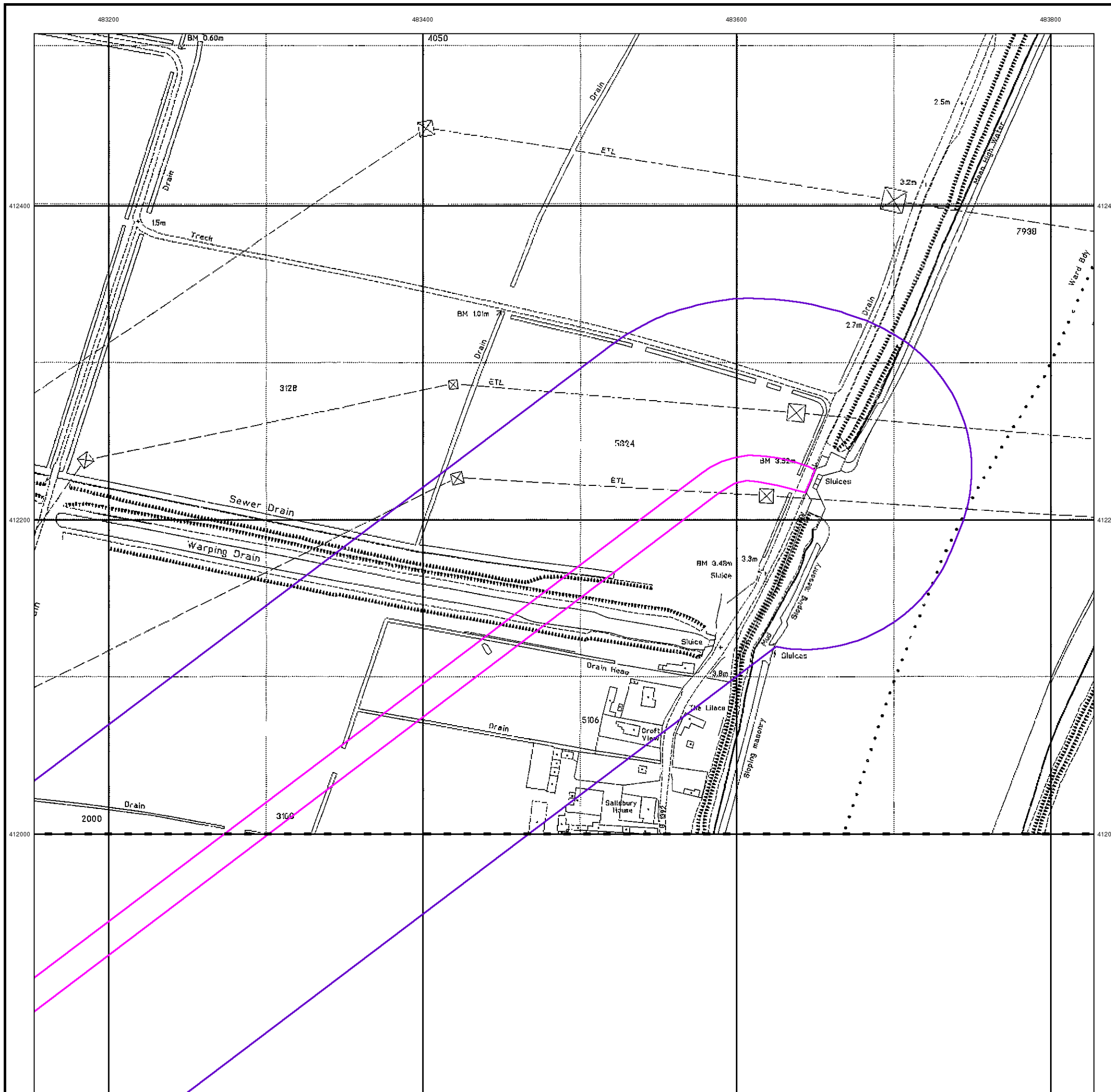

483200

483400

483600

483800

412400

412400

412200

412200

412000

412000



Historical Aerial Photography Published 1999

This aerial photography was produced by Getmapping, these vertical aerial photographs provide a seamless, full colour survey of the whole of Great Britain

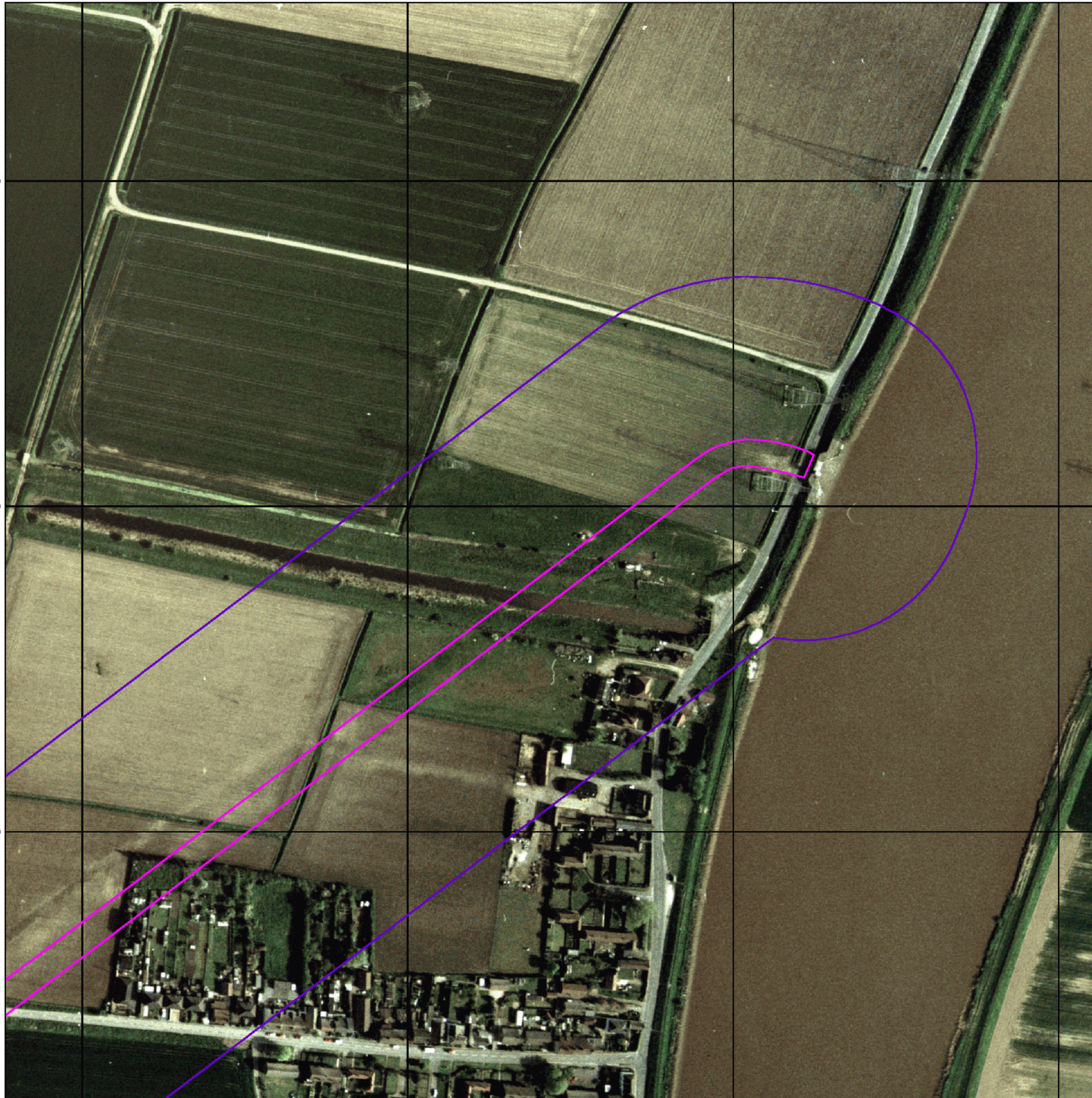

Historical Aerial Photography - Segment B9

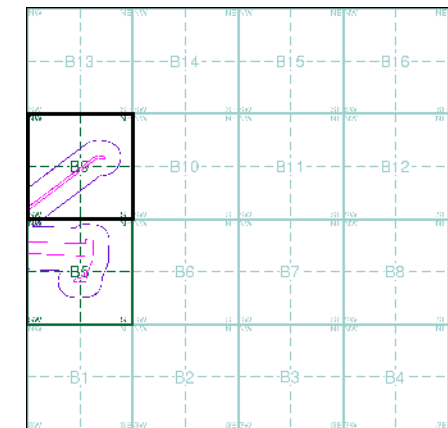

Order Details

Order Number:	242986885_1_1
Customer Ref:	60625943
National Grid Reference:	483610, 411850
Slice:	B
Site Area (Ha):	68.12
Search Buffer (m):	100

Site Details

Keadby



Tel:	0844 844 9952
Fax:	0844 844 9951
Web:	www.envirocheck.co.uk

Index Map

For ease of identification, your site and buffer have been split into Slices, Segments and Quadrants. These are illustrated on the Index Map opposite and explained further below.

Slice

Each slice represents a 1:10,000 plot area (2.7km x 2.7km) for your site and buffer. A large site and buffer may be made up of several slices (represented by a red outline), that are referenced by letters of the alphabet, starting from the bottom left corner of the slice "grid". This grid does not relate to National Grid lines but is designed to give best fit over the site and buffer.

Segment

A segment represents a 1:2,500 plot area. Segments that have plot files associated with them are shown in dark green, others in light blue. These are numbered from the bottom left hand corner within each slice.

Quadrant

A quadrant is a quarter of a segment. These are labelled as NW, NE, SW, SE and are referenced in the datasheet to allow features to be quickly located on plots. Therefore a feature that has a quadrant reference of A7NW will be in Slice A, Segment 7 and the NW Quadrant.

A selection of organisations who provide data within this report:



Envirocheck reports are compiled from 136 different sources of data.

Client Details

Ms L Coles, Aecom Infrastructure & Environment UK Ltd,
Victoria Square House, Victoria Square, Birmingham, B2
4AJ

Order Details

Order Number: 242986885_1_1
Customer Ref: 60625943
National Grid Reference: 482310, 411790
Site Area (Ha): 68.12
Search Buffer (m): 500

Site Details

Keadby

Full Terms and Conditions can be found on the following link:
<http://www.landmarkinfo.co.uk/Terms/Show/515>

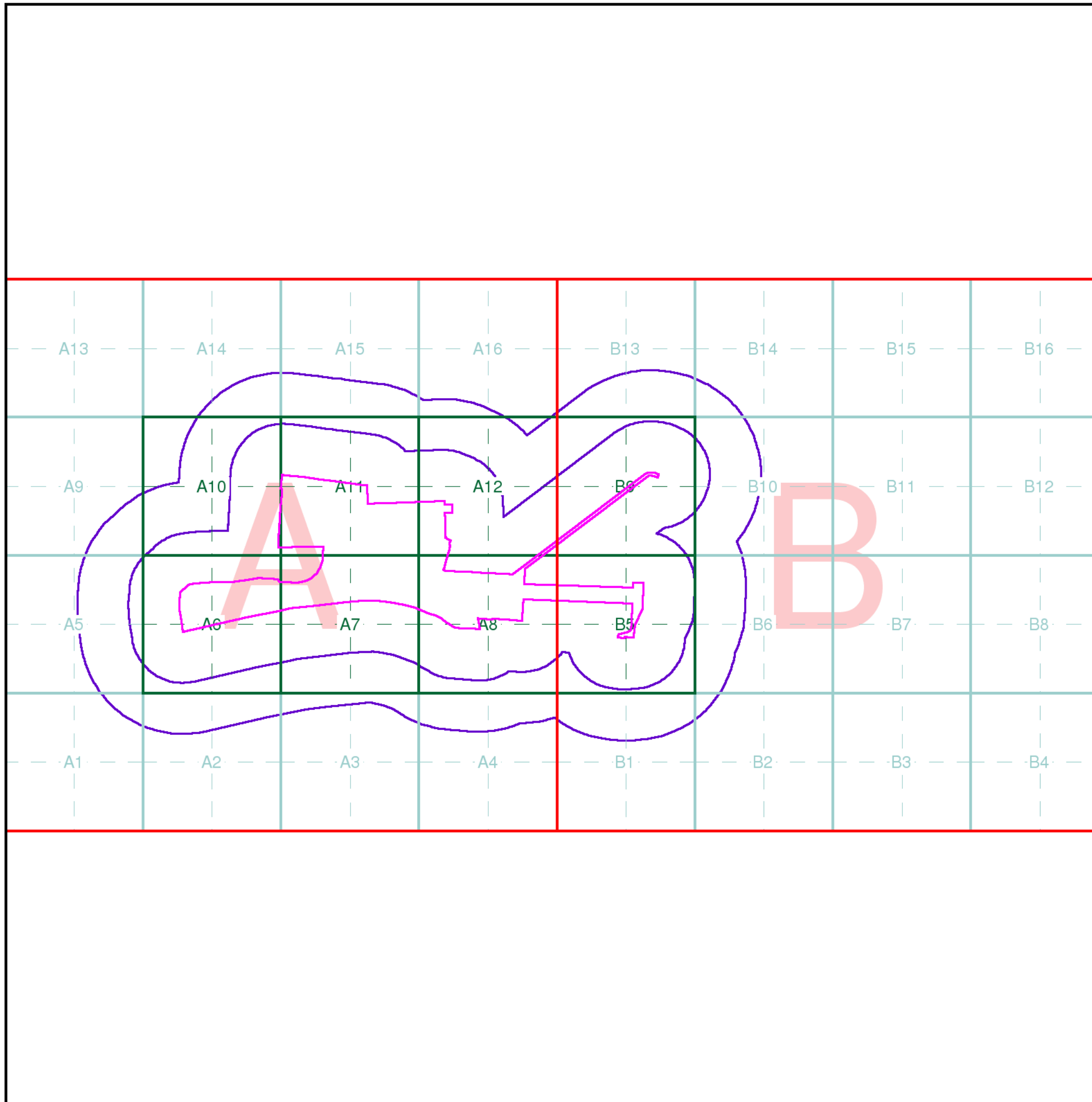

ANNEX C PRELIMINARY UXO THREAT ASSESSMENT

PRELIMINARY UNEXPLODED ORDNANCE (UXO) THREAT ASSESSMENT

Meeting the requirements of CIRIA C681 'Unexploded Ordnance (UXO) – A guide for the Construction Industry' Risk Management Framework

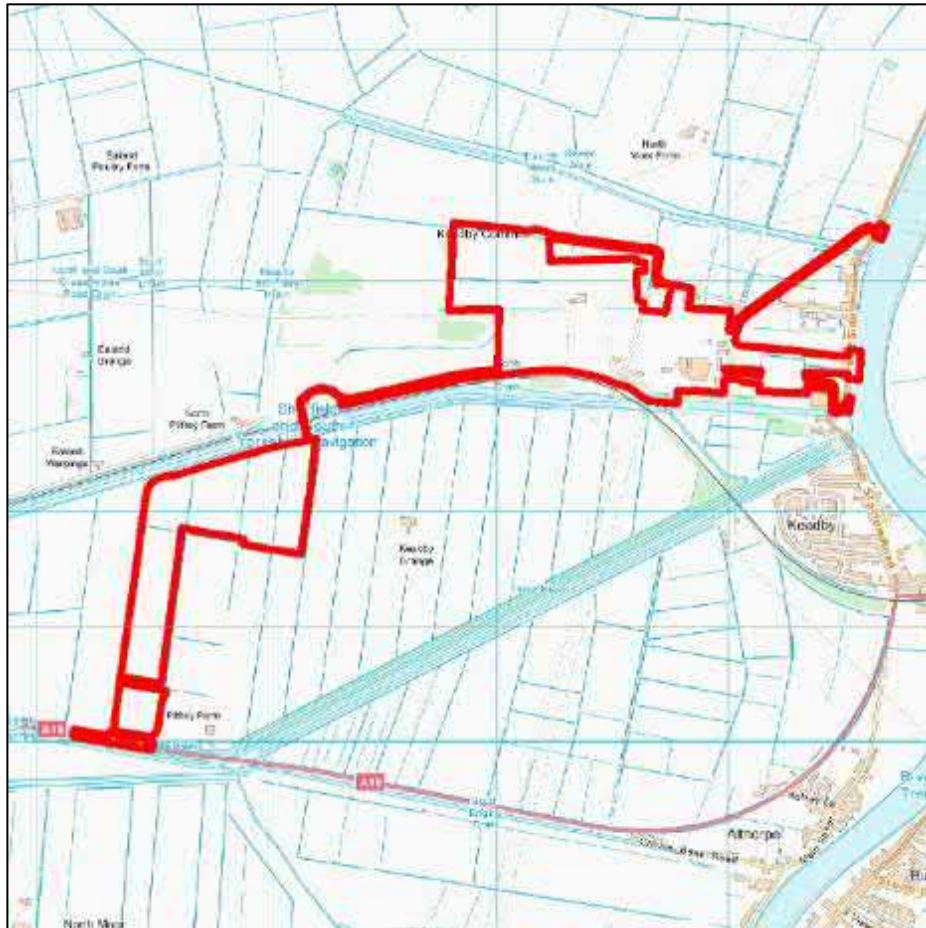

PROJECT NUMBER	8472	ORIGINATOR	D. Barrett
VERSION NUMBER	1.0	REVIEWED BY	L. Gregory (15 th October 2020)
CLIENT	AECOM	RELEASED BY	R. Griffiths (15 th October 2020)
STUDY SITE	Keadby 3 Low-Carbon Gas Power Station Project		
RECOMMENDATION	No further action is required to address the UXO risk at this Study Site		



STUDY SITE

The Study Site is described as “Keadby 3 Low-Carbon Gas Power Station Project”, and it is centred on National Grid Reference 481834, 411442.

THREAT POTENTIAL AND RECOMMENDATIONS

The potential for a UXO hazard to occur, and more specifically, the potential for unexploded WWI and WWII ordnance to exist at this site is assessed as being **UNLIKELY** (*Figure 2*).

In accordance with *CIRIA C681* Chapter 5 on managing UXO risks, *6 Alpha* concludes that **NO FURTHER ACTION** is required to address the UXO risk at this Study Site. Should you have any queries, please contact *6 Alpha*.



REPORT SUMMARY

During WWII, the Study Site was situated within *Isle of Axholme Rural District* and *Glanford Brigg Rural District*, which recorded less than one and one High Explosive (HE) bomb strikes per 100 hectares respectively; both very low levels of bombing.

Luftwaffe aerial reconnaissance photography associated with the Study Site did not identify primary bombing targets on-site, or within 1,000m of the Study Site boundary.

Neither *Air Raid Precaution* (ARP) records nor official bomb damage mapping was available. In addition, further research of historical records and an analysis of post-war mapping did not identify any bomb strikes or bomb damage on-site, or within 1,000m of the Study Site boundary. In addition, whilst WWII-era *RAF* aerial photography might show possible evidence of a ground disturbance within the Study Site (and this is considered doubtful), as there is no anecdotal or recorded site-specific evidence of WWII bombing within 1km of the Study Site, it is considered highly unlikely that any potential ground disturbance is indicative of an HE or UXB bomb strike within the Study Site itself.

Further research did identify evidence that a Prisoner of War (PoW) camp was previously located approximately 640m south-south-east of the Study Site. However, there is no evidence that such activities would have generated a UXO threat at the Study Site.

Therefore, as there was no bombing or bomb damage recorded in the Study Site’s vicinity during WWII, there is no evidence to suggest that further investigation into UXO is warranted.

USING THIS REPORT

This Preliminary Assessment is designed to inform environmental and construction professionals of the potential threat of military related explosives and/or ordnance on, or in, the vicinity of the Study Site.

This assessment is designed to be employed as a site-screening tool to meet with the requirement of Phase One of the *CIRIA UXO Risk Management Framework*; there are two broad prospective outcomes; either the threat level requires a detailed threat & risk assessment; or no further action is required. In the former instance we can provide a report within 10 working days (or more quickly upon application).

Two figures accompany the report, the *Second World War* (WWII) High Explosive (HE) Bomb Density and the final Probability of UXO Encounter. The purpose of this approach is to demonstrate that whilst bomb density statistics give an indication for WWII bombing, they should not be relied upon exclusively to generate a holistic assessment.











For further information, please contact *6 Alpha*:

Website: <http://www.6alpha.com>

Telephone: +44 (0)2033 713 900

Email: enquiry@6alpha.com

DATA FINDINGS

Threat Source (within 1,000m)	Detail	
	Identified	Comments
 Airfields/Military Facilities	✓	A PoW Camp was identified approximately 640m south-south-east of the Study Site.
 Ordnance Manufacture/Storage	✗	None recorded within 1,000m.
 WWII Decoy Bombing Sites	✗	None recorded within 1,000m.
 WWII Defensive Features	✗	None recorded within 1,000m.
 WWII <i>Luftwaffe</i> Designated Bombing Targets	✗	<i>Luftwaffe</i> aerial photography did not identify any primary bombing targets on-site, or within 1,000m of the Study Site boundary.
 WWII Bomb Strikes Within Study Site Boundary	✗	ARP records were not available.
 WWII Bomb Strikes Near Study Site Boundary	✗	ARP records were not available.
 WWII Bomb Damage	✗	Official bomb damage mapping was not available.
 Abandoned Bomb Register	✗	The official abandoned bomb list did not identify any abandoned bombs on-site or within 1,000m of the Study Site boundary.
 Potential Threat Sources	✗	Further research has not uncovered any potential UXO threat sources associated with the Study Site.
 WWII Bombing Density Per 100 Hectares	✓	<i>Isle of Axholme Rural District</i> and <i>Glanford Brigg Rural District</i> , which recorded less than one and one HE bomb strikes per 100 hectares.

IMPORTANT NOTES

1. The term 'Preliminary UXO Threat Assessment' has been used to describe this report, to fall in line with the *CIRIA* C681 guidelines. Whilst the term 'Risk' can be justifiably used at this stage, the reader should note that the 'Consequence' function of 'Risk' is not considered. Should it be required, this would be addressed in the 'Detailed UXO Threat & Risk Assessment' (Stages 2 and 3).
2. This report is accurate and up to date at the time of writing.
3. The assessment levels have been generated from historical data and third party sources. Where possible *6 Alpha* have sought to verify the accuracy of such data, but cannot be held accountable for inherent errors that may be in third party data sets (e.g. *National Archives* or library sources).
4. *6 Alpha* have exercised all reasonable care, skill and due diligence in producing this service.
5. Whilst every effort has been used to identify all potential UXO/explosive threats, there were a number of private facilities, which may not have released privately recorded information concerning UXO/explosive threats into the public domain. It is therefore possible that some of the aforementioned sites may not be included within the database.

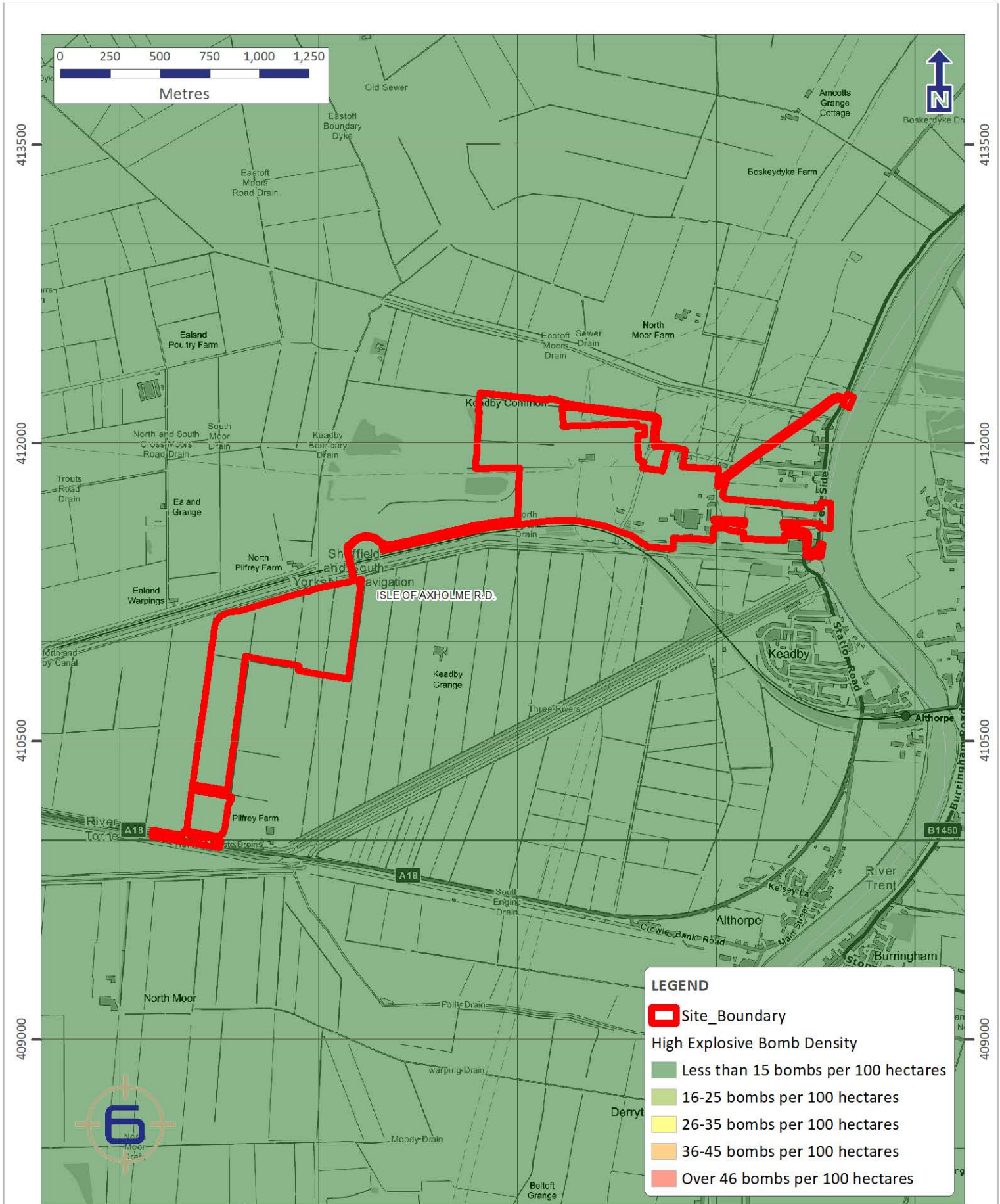



BRITISH NATIONAL GRID

KEADBY 3 LOW-CARBON GAS POWER STATION PROJECT

Probability of UXO Encounter

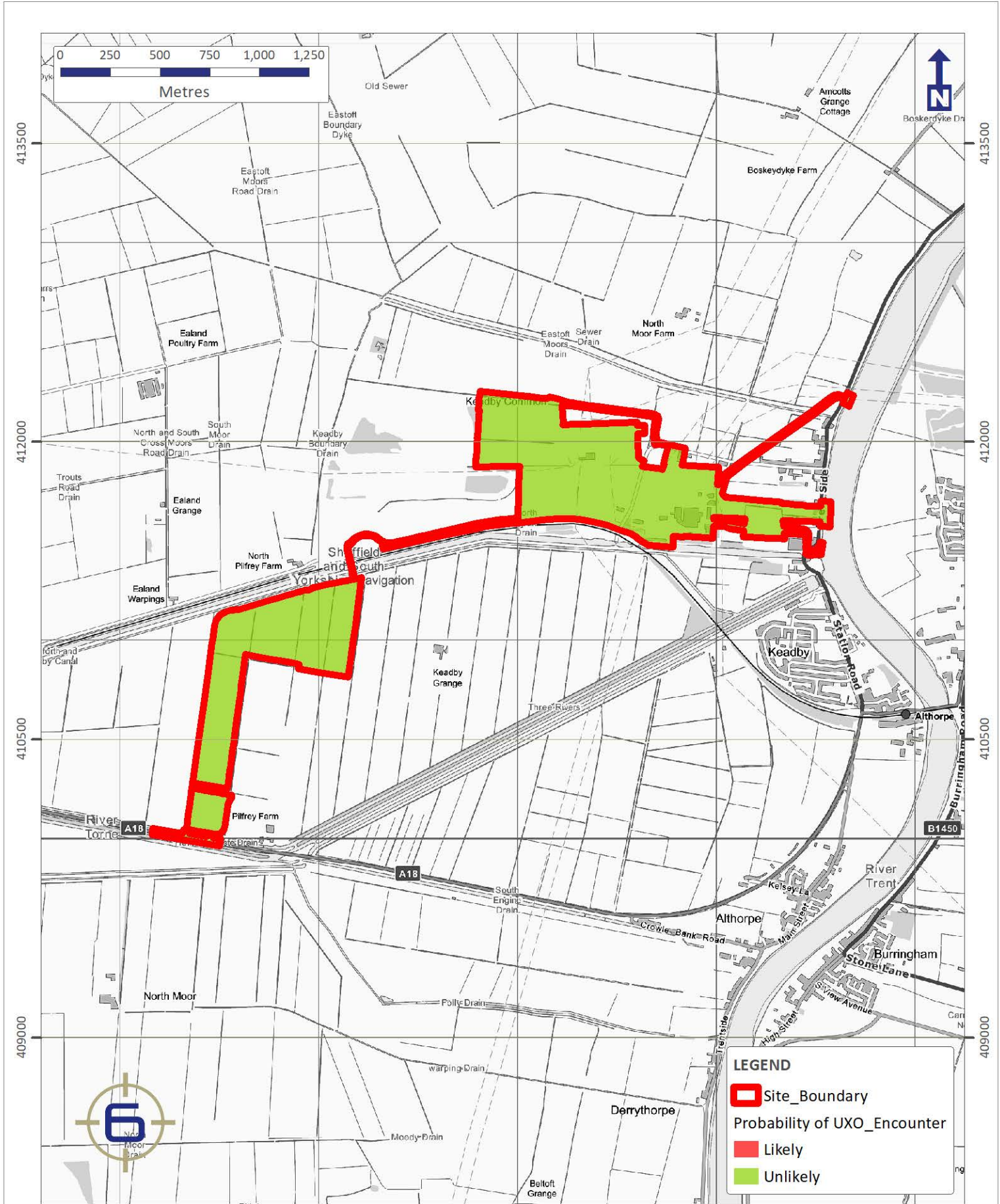

LEGEND

- Site_Boundary
- Probability of UXO_Encounter
- Likely
- Unlikely

PROJECT NO. 8472	FIGURE 2	DRAWN CC	CHECKED LG	DATE 15 October 2020	Contains Ordnance Survey data © Crown copyright and database right 2017	Produced by and Copyright to 6 Alpha Associates Ltd. Users noting any errors please notify 6 Alpha.	
---------------------	-------------	-------------	---------------	-------------------------	--	--	--

ANNEX D UTILITY PLANS



Groundsure Premier Utilities

Keady Power Station West

LOCATION INTELLIGENCE

To access Groundsure's market leading environmental solutions,
please call **08444 159 000** or email **info@groundsure.com**
WWW.GROUNDSURE.COM



Keady Power Station West

**Bonnyhale Road
Keadby
North Lincolnshire
DN17 3ER**

26/10/2020

PROJECT NO.

607277

ISSUE NO.

2

STATUS

For Information

Introduction

This report assesses the potential constraints presented by the existing utility infrastructure both within the boundary and in the vicinity of the search area.

The report is based on the information provided by the client about the location of the search area and the information provided by the utilities about their existing plant and networks. The information contained in this report is based on desk research only.

What is a utility constraint?

We use the term constraint to indicate that there may be limitations or prohibitions on designs and planned works due to the presence of utility apparatus. To overcome these can be costly and time-consuming. Depending on the legal rights and statutory powers of the utility the costs may have to be borne by the applicant/developer.

Report interpretation

We have developed a simple traffic light mechanism to present site constraints based on a red/amber/green evaluation;

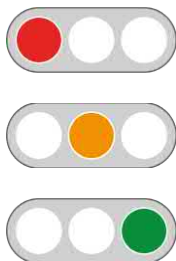

Red – site constraints exist due to the presence of utility apparatus.

Amber – site constraints may exist due to the proximity of utility apparatus.

Green – site constraints do not appear to exist.

This report confirms to QL-D of PAS 128:2014 - Specification for Underground Utility Detection, Verification and Location. To obtain further detail on utility locations consider site reconnaissance (QL-C), detection (QL-B) and verification (QL-A) as recommended under 'Important Information'.

Prepared by

Signed off by



Joe Goodchild

Martin Darlison



Cert No 6206
ISO 9001



Premier Energy Services Ltd has taken all reasonable steps, within the timescales, to obtain the most robust information in this report but accepts no liability for the accuracy of such information or report and in addition to any limitation of liability under its Standard Terms and Conditions. These services are provided subject to our standard Scope of Services, the Supplementary Terms and our Standard Terms and Conditions.

This report is for the private and confidential use of the client for whom the report is undertaken and should not be reproduced in whole or in part or relied upon by third parties for any use whatsoever without the express authority of Premier Energy Services Ltd.

Important Information

This flow diagram is intended to help give an understanding of the process from referring to plans on-site through to the start of excavation, for example when excavating in a road or footway. However it:

- Describes only part of the process; it does not, for example, describe planning the work, including reference to plans at the design stage;
- Is a simplified picture and not a substitute for reading the text;
- Is not a substitute for a suitable and sufficient risk assessment;
- Does not take account of a number of other situations, e.g. cable embedded in concrete or those situations where resiting services is proposed.

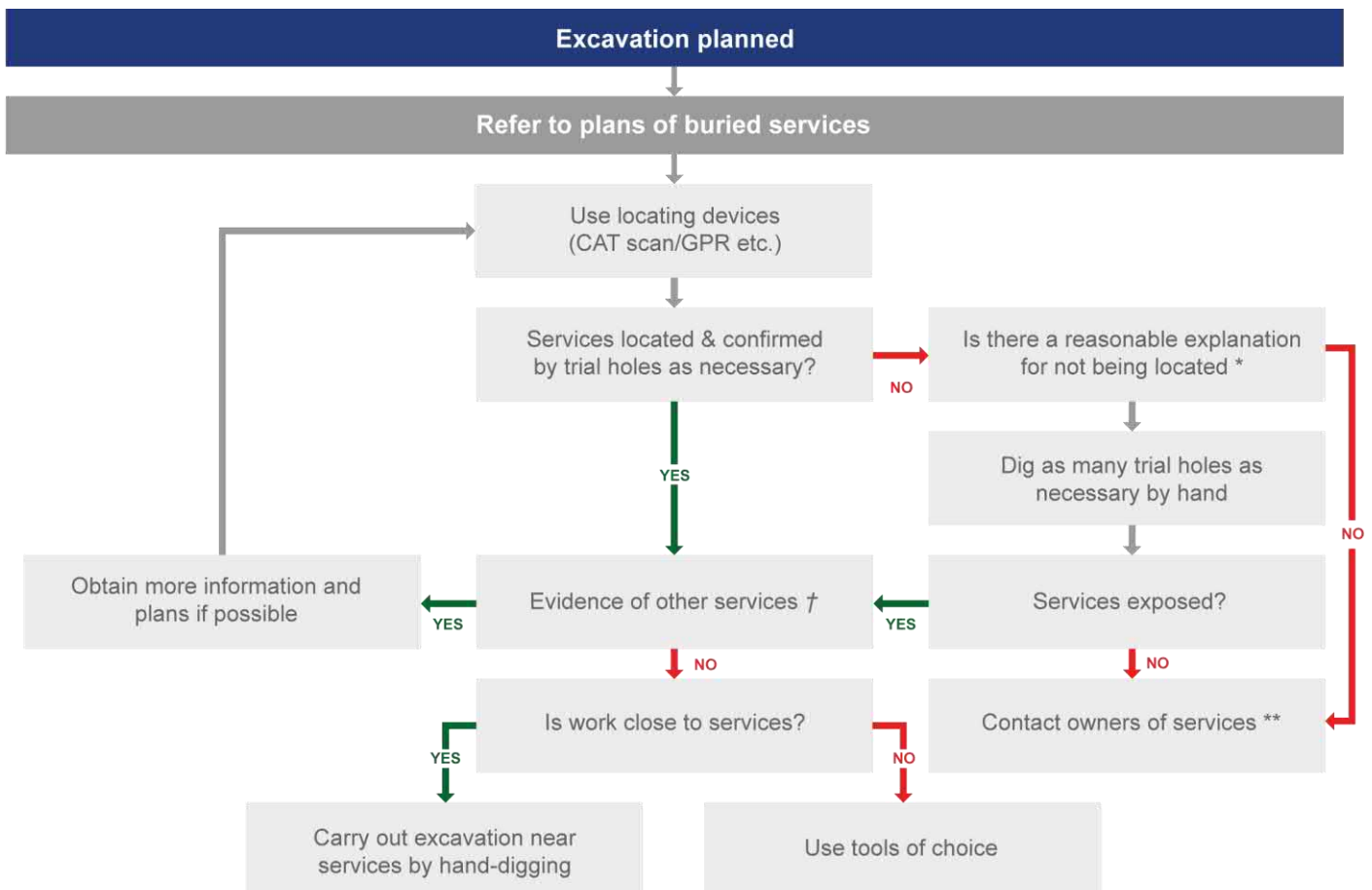

* For example, could services be non-metallic pipes? Please refer to HS (G) 47 text for further information.

† In particular; visual evidence. Ensure that the presence of services, which may be unmarked on plans or for which no plans are available, has been considered, for example service connections.

** If there is visual evidence of services, but owners cannot be traced, despite all reasonable attempts to do so, any excavation could proceed but using hand-dug trial holes and proceeding with great care.

Important Information

Relevant Documents

The following documents must be referred to before work commences in the vicinity of existing services:

- Health and Safety Booklet HS (GS) 6 Avoidance of Danger from Overhead Electric Lines.
- General Safety Measures to Avoid Injury and Damage to Gas Apparatus.
- HSE Guidance Note HS (G) 47 Avoiding Danger from Underground Services.
- National Joint Utilities Group (NJUG) Publications Vol. 1.
- CDM Regulations 2015.
- PAS 128:2014 Specification for Underground Utility Detection, Verification and Location.

Basic Risk Assumption for all Services

When dealing with existing services the following assumptions must always be accepted:

- All existing buildings have gas, water electric and telecoms supplies to them until proven otherwise.
- Any supply to an existing building, no matter how old the building is or how deteriorated the supply may appear, is taken to be 'live' until proven otherwise.
- All open land, vacant lots and derelict sites are deemed to have services beneath them until proven otherwise.
- The only acceptable proof that a service is 'dead' and can be removed is written confirmation from the owner of the service.
- *The quality and accuracy of information provided by utilities about their existing plant is indicative and no warranty is made as to its accuracy. Therefore, any utility asset maps and/or marked up drawings provided by each utility must only be used as a guide and the actual location of plant should be verified by EML/GPR survey or trial holes before construction works commence.*
Please note not all service connections are shown on the utility asset maps.

Plant Found Within Site Boundaries

Where utility plant is found within the site boundary, it is recommended for the client to check for legal easements or wayleaves.

Diversions of plant within site boundaries can be expensive and time consuming to relocate. Further investigation of costs and timescales are recommended. Please ask PES for further details.

Desk Research

With several utility suppliers, PES use their own databases to check if assets are likely to be in the vicinity. These utilities are shown with a tick under the Desk Research column in the Enclosures list. Our utility contact schedule can be provided on request. It must be noted that certain utility companies do not respond if their plant is unaffected and we issue these with a green (unaffected) traffic light unless otherwise informed.

Enclosures

Type	Company	In Vicinity	Desk Research	Awaiting Response
Electricity	Northern Power Grid			
Water	Yorkshire Water			
Drainage	Severn Trent Water			
Gas	Cadent			
Openreach	Openreach			
Virgin Media	Virgin Media			
Independents	GTC			
	Energetics			
Linesearch (LSBUD)	National Grid Gas			
	GTT (inc Vtesse & Interoute)			
Comms.	Vodafone			
	Colt			
	KPN			
	SKY Telecommunications			
	Instalcom			
	Verizon			
	SOTA		✓	
	KCOM		✓	

Type	Company	In Vicinity	Desk Research	Awaiting Response
	TeliaSonera (Telent)		✓	
	euNetworks		✓	
	CityFibre		✓	
	Mast Data			
Tunnels & Pipelines	Onshore Cables		✓	
	ENGIE		✓	
	Eleclink Interconnector		✓	
Transport	Network Rail			
	HS 2 (High Speed Rail)		✓	
	Genesys		✓	
	Trafficmaster		✓	
	Lincolnshire County Council			

Acronyms Key

Apparatus			
Electric			
DNO	Distribution Network Operator	kVA	Kilo Volt Amperes
IDNO	Independent Distribution Network Operator	MVA	Mega Volt Amperes
ICP	Independent Connections Provider	AC	Alternating Current
LV	Low Voltage	S/S	Substation
HV	High Voltage	PMT	Pole Mounted Transformer
EHV	Extra High Voltage		
Water			
SLO	Self Lay Organisation	WRAS	Water Regulation Advisory Scheme
Incumbent	Local Water or Water & Sewerage Company		
Gas			
GDN	Gas Distribution Network	LP	Low Pressure
IGT	Independent Gas Transporter	MP	Medium Pressure
UIP	Utility Infrastructure Provider	IP	Intermediate Pressure
PRS	Pressure Reducing Station (Governor)	HP	High Pressure
Others			
PES	Premier Energy Services	CATV	Cable Television
PE	Polyethylene	FTTP	Fibre to the premise
DI	Ductile Iron	FTTC	Fibre to the cabinet
ST	Steel	l/min	Litres per minute
CI	Cast Iron	H&S	Health & Safety
SI	Spun Iron	HBF	House Builders Federation
HPPE	High Performance Polyethylene	TPO	Tree Preservation Order
MDPE	Medium Density Polyethylene	TBC	To be confirmed
GRP	Glass Reinforced Plastic	N/A	Not Applicable

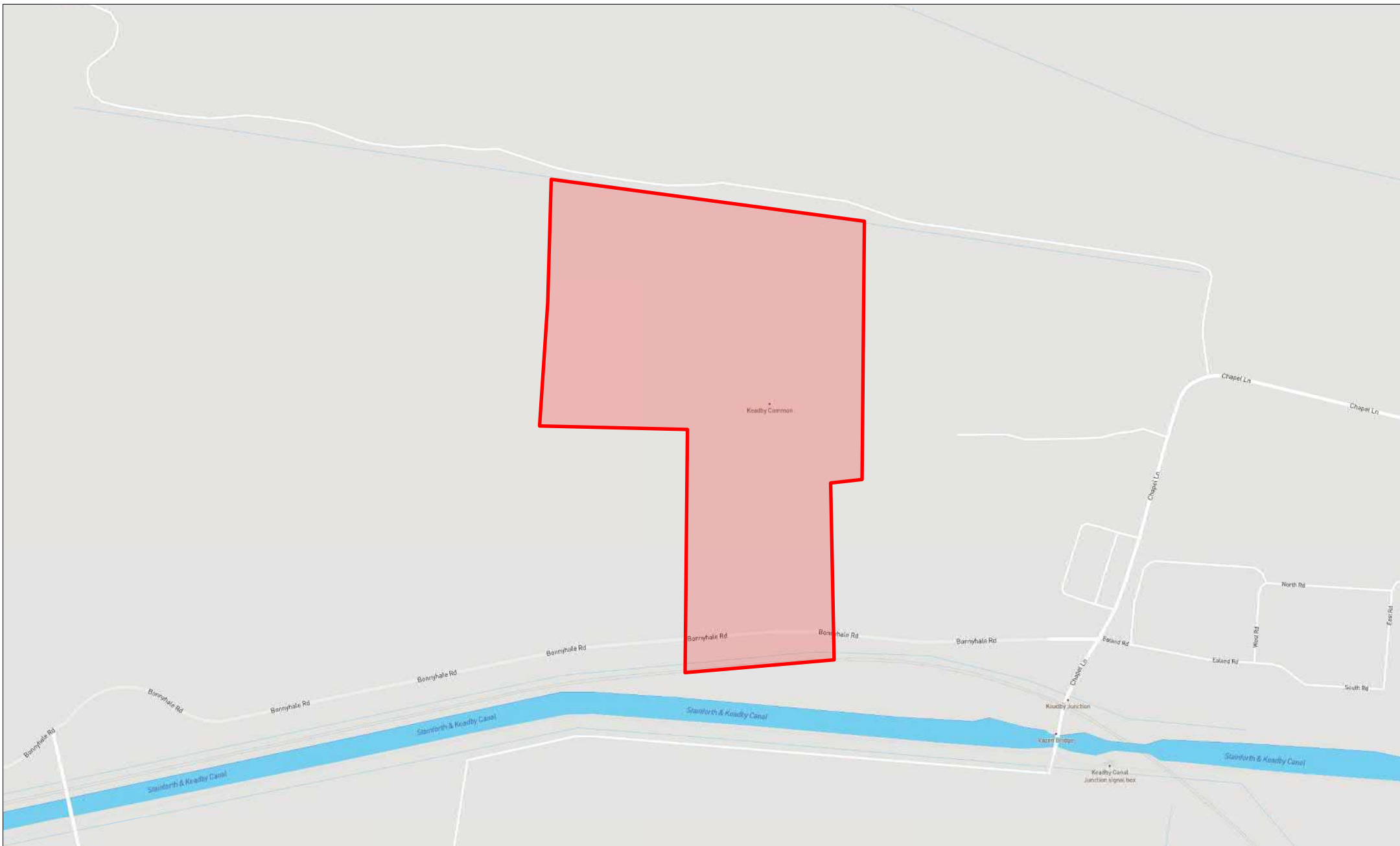



Premier Energy
specialists in utility infrastructure

Request Ref: 507885

Bonnyhale Road, Keadby, North Lincolnshire, DN17 3ER
Eastings 482033, **Northings** 411946

Imagery sourced from ArcGIS World Imagery



Date: 09/10/2020

Joe Goodchild
Premier House
Daux Road
Billingshurst
RH14 9SJ

Tel: 0191 229 4294
Northern Powergrid Records Information Centre
New York Road
Shiremoor
Newcastle Upon Tyne
NE27 0LP

Dear Joe Goodchild

Enquiry No: SD343583
Scheme Reference: 607277 - Keady Power Station West

Thank you for using Northern Powergrid's online Safedig service for your planned works.

Your plan has been generated using our most up to date information. Due to the nature of the information we hold and how often works on the network are carried out, we can only guarantee this plan at the time of generation. We will do our best to notify you if we update the information in your indicated area, but you should endeavour to obtain an up to date plan whenever you commence your works.

The map that has been provided to you will show all the relevant Northern Powergrid electricity cables that are in your indicated dig site, we have included some of the surrounding area as well in case your dig extends further than you previously thought. At any point you may re-apply for your plan to increase the indicated area using the previously submitted details. This plan will be valid for 30 days from the point at which it became available to you.

The enclosed mains records only give the approximate location of known Northern Powergrid apparatus in the area. Great care is therefore needed and all cables and overhead lines must be assumed to be live.

Please note that while all efforts are made to ensure the accuracy of the data, no guarantee can be given. We would refer you to the Health & Safety Executive's publication HS(G)47 "Avoiding Danger From Underground Services" which emphasises that:

- Plans must only be used as a guide in the location of underground cables. The use of a suitable cable-tracing device is essential and careful hand digging of trial holes must be carried out to positively identify and mark the exact route of the cable. You should also bear in mind that a cable is unmistakably located only when it has been safely exposed.
- Cable depths are not generally indicated on our records and can vary considerably even when shown.
- Great caution must be exercised at all times when using mechanical plant. Careful trial digging should always be carried out on the whole route of the planned excavation to ascertain if cables exist.

The Health & Safety executive have another publication, GS6 "Avoidance of Danger from Overhead Electric Lines" that you should be aware of if your work is near overhead powerlines. Both of these documents provide comprehensive guidance for observance of statutory duties under the Electricity at Work Regulations 1989 and the Health & Safety at Work Act 1974. Our provision of these records is based upon the assumption that people using them will have sufficient competence to interpret the information given. Any damage or injury caused will be the responsibility of the organization concerned who will be charged for any repairs.

Please note ground cover must not be altered either above our cables or below overhead lines, in addition no trees should be planted within 3 metres of existing underground cables or 10 metres of overheadlines. All our apparatus is legally covered by a wayleaves agreement, lease or deed or alternatively protected under



Assume all Northern Powergrid assets are live, unless proved otherwise

Please establish the on-site position of Northern Powergrid assets prior to the commencement of site works

For specialist assistance or enquiries, please use one of the following options:

General enquiries- 0800 011 3332

- Option 1 -Electricity emergency or power cut
- Option 2- Electricity bill enquiries
- Option 3- New connection, disconnection, meter enquiry, increased load, service alteration
- Option 4- Request for Safedig Plans
- Option 5- Other general enquiries; including request for site visit, safe working heights

Public safety emergency line -(0800 151 3255)

- Reports of exposed underground cables, grounded overhead conductors etc.

Network connections or diversions - 0800 011 3433

- Maximum load enquiries, connection quotation

Wayleave enquiries- Northeast (0191 229 4604) or Yorkshire (01977 605 104)

- Queries relating to ownership of assets, wayleave agreements

If site works are to be performed more than 3 months after you have received safe dig plans from Northern Powergrid, it is advisable that you request a more up to date copy.

Call Centre Phone Numbers: If the area is located in: North East call 0800 668877, Yorkshire or North Lincs call 0800 375675.

Northern Powergrid Holdings Company

The position of our equipment is shown on the plan as accurately as possible, it may have changed since the plan was produced. Therefore the position of our equipment and those services which may not be shown should be established on site. Electricity cables not owned by Northern Powergrid Holdings Company may be laid in this area and may not be shown on this plan. Where private cables are shown, the information should not be regarded as accurate and should be used for guidance purposes only. In all cases, accurate information should be obtained from the owner of such cables prior to the commencement of work on site.

Reference should be made to HSE Guidance, HS(G)47 'Avoiding Danger from Underground Services' and GS6 'Avoidance of Danger from Overhead Power Lines'.

Reproduced from or based upon the Ordnance Survey map by Northern Powergrid Holdings Company by permission of Ordnance Survey on behalf of the Controller of Her Majesty's Stationary Office. Crown (c) Copyright (Northern Powergrid Holdings Company. EL100017931 and EL100036857).

Legend:

Underground Cables:

132kV	20kV	LV Mains
66kV	11kV	LV Service
33kV	6kV	LV Service Assumed Route
25kV	3kV	LV Service Logical Connection
Left In Situ	Aux	

Overhead Conductors:

132kV	20kV	LV Mains
66kV	11kV	LV Service
33kV	6kV	Aux
25kV	3kV	

Date Printed:

Scale: 1:

Wind Farm

Ring Drain

Sewer

Keadby Common

Keadby Junction

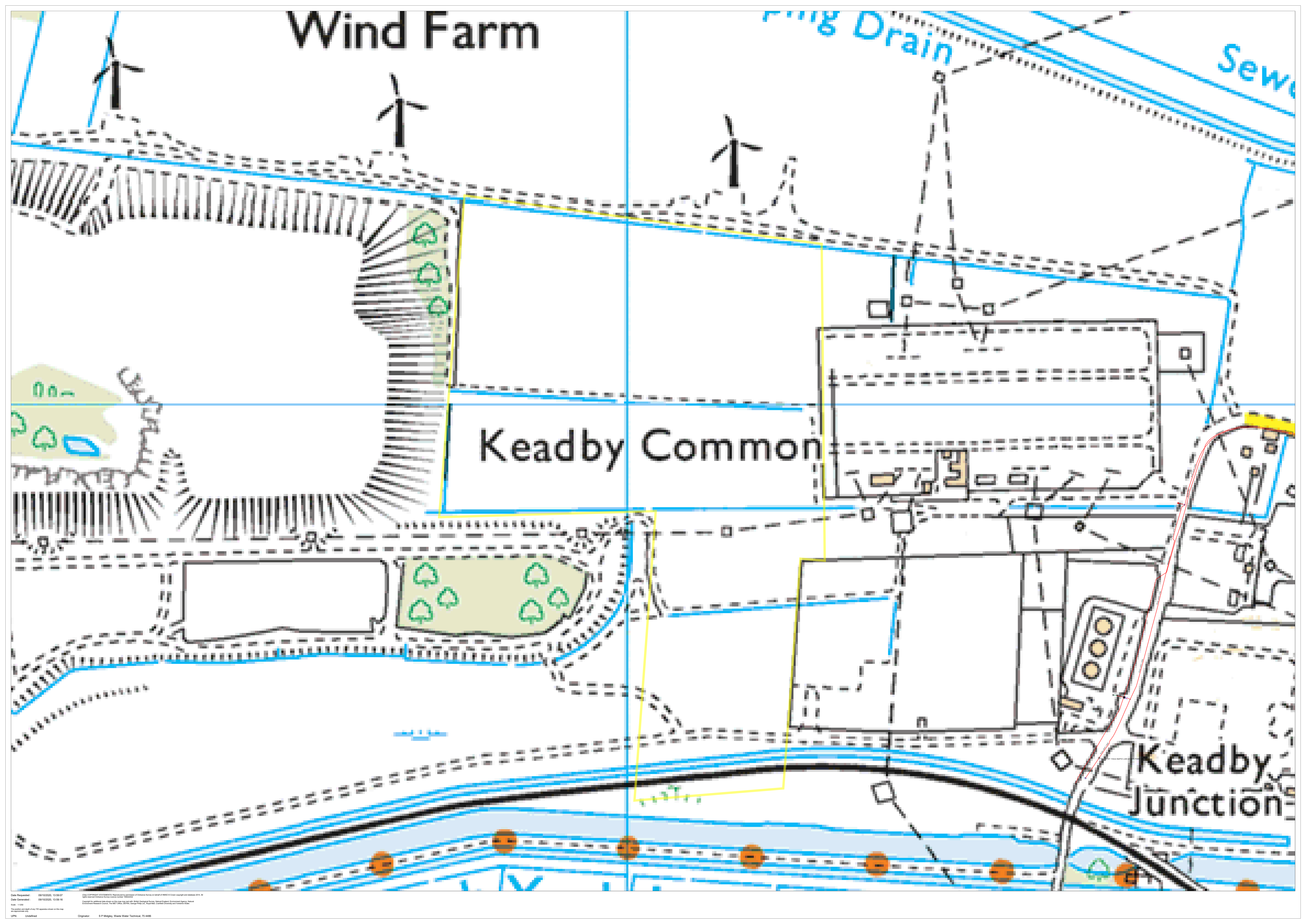

Property Identifier



Sewer Legend

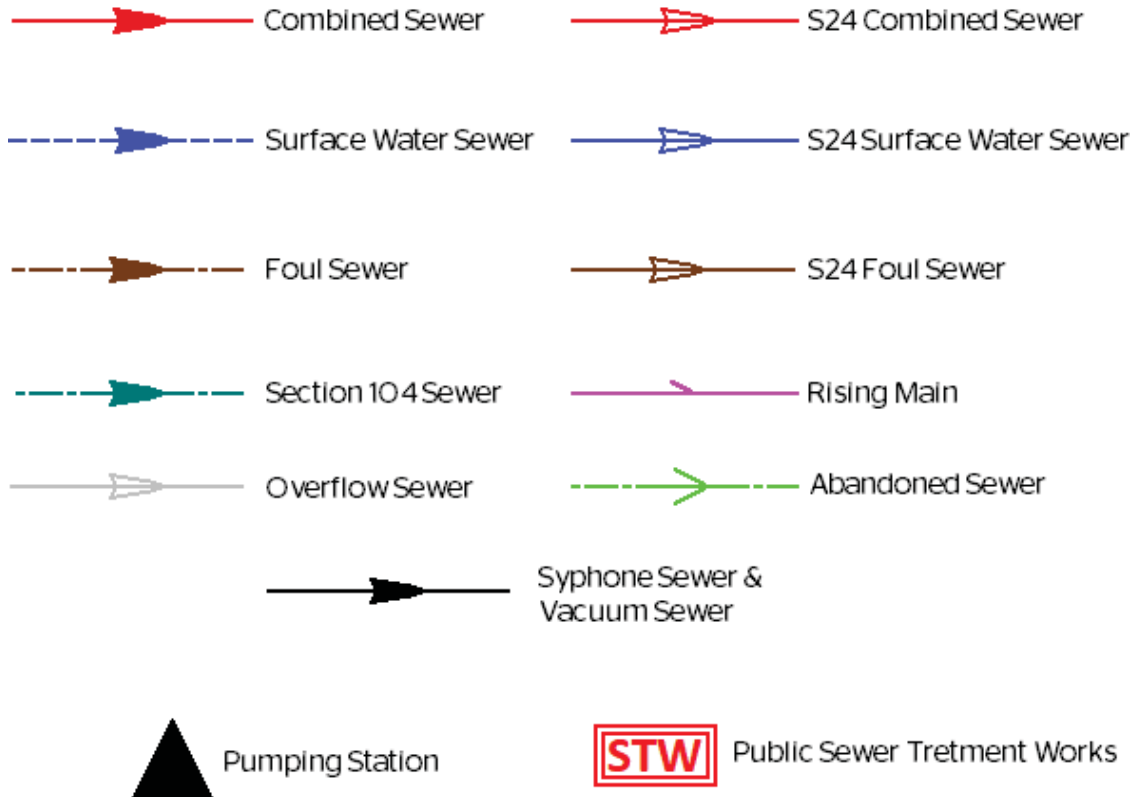

Water Legend

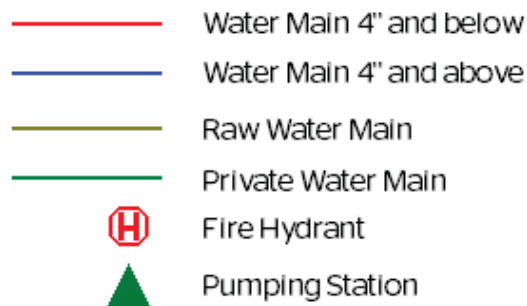

YORKSHIRE WATER PROTECTION OF MAINS AND SERVICES

1. The position of Yorkshire Water Services Ltd (YWS) apparatus shown on the existing mains record drawing(s) indicates the **general** position and nature of our apparatus and the accuracy of this information cannot be guaranteed. Any damage to YWS apparatus as a result of your works may have serious consequences and you will be held responsible for all costs incurred. Prior to commencing major works, the exact location of apparatus must be determined on site, if necessary by excavating trial holes. The actual position of such apparatus and that of service pipes which have not been indicated must be established on site by contacting the Customer Helpline on 0845 124 24 24 for both water and sewerage.
2. The public sewer and water network is lawfully retained in its existing position and the sewerage and water undertaker is entitled to have it remain so without any disturbance. The provisions of section 159 of the Water Industry Act 1991 provides that the undertaker may "inspect, maintain, adjust, repair or alter" the network. Those rights are given to enable the undertaker to perform its statutory duties. Any development of the land or any other action that unacceptably hindered the exercise of those rights would be unlawful. The provisions contained in Section 185 of the Water Industry Act 1991 state that where it is reasonable to do so, a person may require the water supply undertaker to alter or remove a pipe where it is necessary to enable that person to carry out a proposed change of use of the land. The provisions contained in Section 185 also require the person making the request to pay the full cost of carrying out the necessary works.
3. Ground levels over existing YWS apparatus are to be maintained. Sewers in highways will **generally** be laid to give 1200mm of cover from finished ground level working to kerb races, other permanent identification of the limits of the road or to an agreed line and level. Substantial increases or decreases to this 1200mm depth of cover will result in the sewer being re-laid at your expense. Water mains and services will **generally** be laid with a minimum of 750mm depth of cover however some mains and services usually those installed over 50 years ago may have less ground cover.
4. If surface levels are to be decreased / increased significantly the effects on existing water supply apparatus will be carefully considered and if any alterations are necessary, the costs of the alterations will be recharged to you in full. Outlets on fire hydrants must be no more than 300mm below the new levels and all surface boxes must be adjusted as part of the scheme.
5. To enable future repair works to be carried out without hindrance; any pipe, cable, duct, etc. installed parallel to a water main or service pipe should not be installed directly over or within 300mm of a water main or service pipe or 1000mm of a waste water asset. Where a pipe, cable, duct, etc. crosses a main or service it should preferably cross perpendicular or at an angle of no less than 45° and with a minimum clearance of 150mm. These requirements apply to activities within an existing highway and are relevant to the installation of pipes, cables, ducts, etc. up to and including 250mm in diameter (*see illustration below*). Necessary protection measures for installations greater than 250mm in diameter and/or in private land will need to be agreed on an individual basis. Installations within a new development site must comply with the National Joint Utilities Group publication Volume 2: NJUG Guidelines On The Positioning Of Underground Utilities Apparatus For New Development Sites.
6. All excavation works near to YW apparatus should be by hand digging only.
7. Backfilling with a suitable material to a minimum 300mm above YW apparatus is required.
8. Adequate support must be provided where any works pass under YW apparatus.
9. Jointing chambers, lighting columns and other structures must be installed in such a way that future repair or maintenance works to YW apparatus will not be hindered.
10. Apparatus such as; railings, sign posts, etc. must not be placed in such a way that they prevent access to or full operation of controlling valves, hydrants or similar apparatus. YWS surface boxes must not be covered or buried. Any adjustment, alteration or replacement of manhole covers must be agreed on site prior to the commencement of the works with a YWS Inspector who may be contacted via our Call Centre on 0845 124 24 24.
11. Explosives shall not be used within 100 metres of any Yorkshire Water Services apparatus or installations.
12. Vibrating plant should not be used directly over any apparatus. Movement or operation by vehicles or heavy plant is not to be permitted in the immediate vicinity of YWS plant or apparatus unless there has been prior consultation and, if necessary, adequate protection provided without cost to YWS.
13. **Under no circumstances** should thrust boring or similar trenchless techniques commence until the actual position of the Company's mains/services along the proposed route have been confirmed by trial holes.
14. Any alterations to the highway should be notified following the procedures outlined in the New Road and Street Works Act 1991 Code of Practice; Measures Necessary Where Apparatus Is Affected By Major Works (Diversionary Works).
15. You will be held responsible for any damage or loss to YWS apparatus during and after completion of work, caused by yourselves, your servant or agent. Any damage caused or observed to YWS plant or apparatus should be immediately reported to YWS. Should YW incur any costs as a result of non-compliance with the above, all costs will be rechargeable in full.
16. You should ensure that nothing is done on the site to prejudice the safety or operation of YWS employees, plant or apparatus.
17. In accordance with the New Roads and Street Works Act 1991, Chapter 22, Part 3, Section 80. The location of any identified YW asset "*which is not marked, or is wrongly marked, on the records made available*" should be communicated back to Yorkshire Water. The location of the apparatus should be identified on copies of the supplied plans which should be returned to Yorkshire Water (Asset Records Team) with photographic supporting evidence where possible.
18. The Government has decided that responsibility for private sewers serving two or more properties and lateral drains (the section of pipe beyond the boundary of a single property, connecting it to the public sewer) will be transferred to the water companies on Oct 1 2011.

Private pumping stations will also transfer during the period 1 October 2011 – 1 Oct 2016. Records of these assets may not yet be shown on the existing mains record drawing(s). If you encounter any of these assets you must inform Yorkshire Water Services Ltd (YWS).

19. Please note that the information supplied on the enclosed plans is reproduced from Ordnance Survey material with the permission of the Ordnance Survey on behalf of the Controller of Her Majesty's Stationery Office, © Crown Copyright. Unauthorised reproduction infringes Crown Copyright and may lead to prosecution or civil proceedings. Licence Number 1000019559.
20. This information is for guidance only and the position and depth of any YW apparatus is approximate only. Likewise, the nature and condition of any YW apparatus cannot be guaranteed. YW has no responsibility for recording the locations of privately owned apparatus. As of 1 October 2011, there may be some lateral drains and/or public sewers which are not documented on YW records but may still be present. For the avoidance of doubt, this information is not a substitute for appropriate professional and/or legal advice. YW accepts no responsibility for any inaccuracy or omissions in this information. The actual position of YW apparatus must be determined on site by excavating trial holes by hand. YW requires a minimum of two working days' written notice of the intention to excavate any trial holes before any excavation can be undertaken. If there are any queries in this respect please contact Yorkshire Water on 0845 124 24 24.

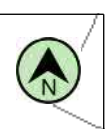

Ordnance Survey © Crown Copyright, 100018507

There are no assets within this map area



Ordnance Survey © Crown Copyright, 100018507

There are no assets within this map area



Ordnance Survey © Crown Copyright, 100018507

There are no assets within this map area



Ordnance Survey © Crown Copyright, 100018507

There are no assets within this map area



Ordnance Survey © Crown Copyright, 100018507

There are no assets within this map area



Ordnance Survey © Crown Copyright, 100018507

There are no assets within this map area



Ordnance Survey © Crown Copyright, 100018507

There are no assets within this map area



Ordnance Survey © Crown Copyright, 100018507

There are no assets within this map area



Ordnance Survey © Crown Copyright, 100018507

There are no assets within this map area



Ordnance Survey © Crown Copyright, 100018507

There are no assets within this map area



Ordnance Survey © Crown Copyright, 100018507

There are no assets within this map area



Ordnance Survey © Crown Copyright, 100018507

There are no assets within this map area



Ordnance Survey © Crown Copyright, 100018507

There are no assets within this map area



Ordnance Survey © Crown Copyright, 100018507

There are no assets within this map area



Ordnance Survey © Crown Copyright, 100018507

There are no assets within this map area



Ordnance Survey © Crown Copyright, 100018507

There are no assets within this map area



Ordnance Survey © Crown Copyright, 100018507

There are no assets within this map area



Ordnance Survey © Crown Copyright, 100018507

There are no assets within this map area



Ordnance Survey © Crown Copyright, 100018507

There are no assets within this map area



Ordnance Survey © Crown Copyright, 100018507

There are no assets within this map area



Ordnance Survey © Crown Copyright, 100018507

There are no assets within this map area



Ordnance Survey © Crown Copyright, 100018507

There are no assets within this map area



Ordnance Survey © Crown Copyright, 100018507

There are no assets within this map area



Ordnance Survey © Crown Copyright, 100018507

There are no assets within this map area



Ordnance Survey © Crown Copyright, 100018507

There are no assets within this map area



Ordnance Survey © Crown Copyright, 100018507

There are no assets within this map area



Ordnance Survey © Crown Copyright, 100018507

There are no assets within this map area



Ordnance Survey © Crown Copyright, 100018507

There are no assets within this map area



Ordnance Survey © Crown Copyright, 100018507

There are no assets within this map area



Ordnance Survey © Crown Copyright, 100018507

There are no assets within this map area



Ordnance Survey © Crown Copyright, 100018507

There are no assets within this map area



Ordnance Survey © Crown Copyright, 100018507

There are no assets within this map area



Ordnance Survey © Crown Copyright, 100018507

There are no assets within this map area



Ordnance Survey © Crown Copyright, 100018507

There are no assets within this map area



Ordnance Survey © Crown Copyright, 100018507

There are no assets within this map area



Ordnance Survey © Crown Copyright, 100018507

There are no assets within this map area



Ordnance Survey © Crown Copyright, 100018507

There are no assets within this map area



Ordnance Survey © Crown Copyright, 100018507

There are no assets within this map area



Ordnance Survey © Crown Copyright, 100018507

There are no assets within this map area



Ordnance Survey © Crown Copyright, 100018507

There are no assets within this map area



Ordnance Survey © Crown Copyright, 100018507

There are no assets within this map area



Ordnance Survey © Crown Copyright, 100018507

There are no assets within this map area



Ordnance Survey © Crown Copyright, 100018507

There are no assets within this map area



Ordnance Survey © Crown Copyright, 100018507

There are no assets within this map area



Ordnance Survey © Crown Copyright, 100018507

There are no assets within this map area

© Crown copyright and database rights 2020 Ordnance Survey 100018507 Scale: 1:250 Date: 09/10/20 Map Centre: 481994.411908 Our Ref: 446631 - 1 Wastewater Plan A1 Powered by dig

Public Foul Gravity/Lateral Drain	Highway Drain	Manhole Foul	Manhole Surface
Public Combined Gravity/Lateral Drain	Overflow Pipe	Manhole Surface	Manhole Surface
Public Surface Water Gravity/Lateral Drain	Disposal Pipe	Abandoned Pipe	Abandoned Pipe
Pressure Foul	Culverted Water Course	Section 156 sewers are shown in green	Private sewers are shown in magenta
Pressure Combined	Pumping Station		
Pressure Surface Water	Fitting		

joegoodchild@premierenergy.co.uk

607277 - Keady Power



Do not scale off this Map. This plan and any information supplied with it is furnished as a general guide, is only valid at the date of issue and no warranty as to its correctness is given or implied. In particular this plan and any information shown on it must not be relied upon in the event of any development or works (including but not limited to excavations) in the vicinity of SEVERN TRENT WATER assets or for the purposes of determining the suitability of a point of connection to the sewerage or distribution systems. On 1 October 2011 most private sewers and private lateral drains in Severn Trent Water's sewerage area, which were connected to a public sewer as at 1 July 2011, transferred to the ownership of Severn Trent Water and became public lateral drains. A further transfer takes place on 1 October 2012. Private pumping stations, which form part of these sewers or lateral drains, will transfer to ownership of Severn Trent Water on or before 1 October 2016. Severn Trent Water does not possess complete records of these assets. These assets may not be displayed on the map. Reproduction by permission of Ordnance Survey on behalf of HMSO. © Crown Copyright and database rights 2020. All rights reserved. Ordnance Survey licence number: 10001673. Document users other than SEVERN TRENT WATER business users are advised that this document is provided for reference purpose only and is subject to copyright, therefore, no further copies should be made from it.

GENERAL CONDITIONS AND PRECAUTIONS TO BE TAKEN WHEN CARRYING OUT WORK ADJACENT TO SEVERN TRENT WATER'S APPARATUS

Please ensure that a copy of these conditions is passed to your representative and/or your contractor on site. If any damage is caused to Severn Trent Water Limited (STW) apparatus (defined below), the person, contractor or subcontractor responsible must inform STW immediately on: **0800 783 4444 (24 hours)**

- a) These general conditions and precautions apply to the public sewerage, water distribution and cables in ducts including (but not limited to) sewers which are the subject of an Agreement under Section 104 of the Water Industry Act 1991 (a legal agreement between a developer and STW, where a developer agrees to build sewers to an agreed standard, which STW will then adopt); mains installed in accordance with an agreement for the self-construction of water mains entered into with STW and the assets described at condition b) of these general conditions and precautions. Such apparatus is referred to as "STW Apparatus" in these general conditions and precautions.
- b) Please be aware that due to The Private Sewers Transfer Regulations June 2011, the number of public sewers has increased, but many of these are not shown on the public sewer record. However, some idea of their positions may be obtained from the position of inspection covers and their existence must be anticipated.
- c) On request, STW will issue a copy of the plan showing the approximate locations of STW Apparatus although in certain instances a charge will be made. The position of private drains, private sewers and water service pipes to properties are not normally shown but their presence must be anticipated. This plan and the information supplied with it is furnished as a general guide only and STW does not guarantee its accuracy.
- d) STW does not update these plans on a regular basis. Therefore the position and depth of STW Apparatus may change and this plan is issued subject to any such change. Before any works are carried out, you should confirm whether any changes to the plan have been made since it was issued.
- e) The plan must not be relied upon in the event of excavations or other works in the vicinity of STW Apparatus. It is your responsibility to ascertain the precise location of any STW Apparatus prior to undertaking any development or other works (including but not limited to excavations).
- f) No person or company shall be relieved from liability for loss and/or damage caused to STW Apparatus by reason of the actual position and/or depths of STW Apparatus being different from those shown on the plan.

In order to achieve safe working conditions adjacent to any STW Apparatus the following should be observed:

1. All STW Apparatus should be located by hand digging prior to the use of mechanical excavators.
2. All information set out in any plans received from us, or given by our staff at the site of the works, about the position and depth of the mains, is approximate. Every possible precaution should be taken to avoid damage to STW Apparatus. You or your contractor must ensure the safety of STW Apparatus and will be responsible for the cost of repairing any loss and/or damage caused (including without limitation replacement parts).
3. Water mains are normally laid at a depth of 900mm. No records are kept of customer service pipes which are normally laid at a depth of 750mm; but some idea of their positions may be obtained from the position of stop tap covers and their existence must be anticipated.
4. During construction work, where heavy plant will cross the line of STW Apparatus, specific crossing points must be agreed with STW and suitably reinforced where required. These crossing points should be clearly marked and crossing of the line of STW Apparatus at other locations must be prevented.
5. Where it is proposed to carry out piling or boring within 20 metres of any STW Apparatus, STW should be consulted to enable any affected STW Apparatus to be surveyed prior to the works commencing.
6. Where excavation of trenches adjacent to any STW Apparatus affects its support, the STW Apparatus must be supported to the satisfaction of STW. Water mains and some sewers are pressurised and can fail if excavation removes support to thrust blocks to bends and other fittings.
7. Where a trench is excavated crossing or parallel to the line of any STW Apparatus, the backfill should be adequately compacted to prevent any settlement which could subsequently cause damage to the STW Apparatus. In special cases, it may be necessary to provide permanent support to STW Apparatus which has been exposed over a length of the excavation before backfilling and reinstatement is carried out. There should be no concrete backfill in contact with the STW Apparatus.
8. No other apparatus should be laid along the line of STW Apparatus irrespective of clearance. Above ground apparatus must not be located within a minimum of 3 metres either side of the centre line of STW Apparatus for smaller sized pipes and 6 metres either side for larger sized pipes without prior approval. No manhole or chamber shall be built over or around any STW Apparatus.
9. A minimum radial clearance of 300 millimetres should be allowed between any plant or equipment being installed and existing STW Apparatus. We reserve the right to increase this distance where strategic assets are affected.
10. Where any STW Apparatus coated with a special wrapping is damaged, even to a minor extent, STW must be notified and the trench left open until the damage has been inspected and the necessary repairs have been carried out. In the case of any material damage to any STW Apparatus causing leakage, weakening of the mechanical strength of the pipe or corrosion-protection damage, the necessary remedial work will be recharged to you.
11. It may be necessary to adjust the finished level of any surface boxes which may fall within your proposed construction. Please ensure that these are not damaged, buried or otherwise rendered inaccessible as a result of the works and that all stop taps, valves, hydrants, etc. remain accessible and operable. Minor reduction in existing levels may result in conflict with STW Apparatus such as valve spindles or tops of hydrants housed under the surface boxes. Checks should be made during site investigations to ascertain the level of such STW Apparatus in order to determine any necessary alterations in advance of the works.
12. With regard to any proposed resurfacing works, you are required to contact STW on the number given above to arrange a site inspection to establish the condition of any STW Apparatus in the nature of surface boxes or manhole covers and frames affected by the works. STW will then advise on any measures to be taken, in the event of this a proportionate charge will be made.
13. You are advised that STW will not agree to either the erection of posts, directly over or within 1.0 metre of valves and hydrants,
14. No explosives are to be used in the vicinity of any STW Apparatus without prior consultation with STW.

TREE PLANTING RESTRICTIONS

There are many problems with the location of trees adjacent to sewers, water mains and other STW Apparatus and these can lead to the loss of trees and hence amenity to the area which many people may have become used to. It is best if the problem is not created in the first place. Set out below are the recommendations for tree planting in close proximity to public sewers, water mains and other STW Apparatus.

15. Please ensure that, in relation to STW Apparatus, the mature root systems and canopies of any tree planted do not and will not encroach within the recommended distances specified in the notes below.
16. Both Poplar and Willow trees have extensive root systems and should not be planted within 12 metres of a sewer, water main or other STW Apparatus.
17. The following trees and those of similar size, be they deciduous or evergreen, should not be planted within 6 metres of a sewer, water main or other STW Apparatus. E.g. Ash, Beech, Birch, most Conifers, Elm, Horse Chestnut, Lime, Oak, Sycamore, Apple and Pear. Asset Protection Statements Updated May 2014
18. STW personnel require a clear path to conduct surveys etc. No shrubs or bushes should be planted within 2 metre of the centre line of a sewer, water main or other STW Apparatus.
19. In certain circumstances, both STW and landowners may wish to plant shrubs/bushes in close proximity to a sewer, water main or other STW Apparatus for screening purposes. The following are shallow rooting and are suitable for this purpose: Blackthorn, Broom, Cotoneaster, Elder, Hazel, Laurel, Privet, Quickthorn, Snowberry, and most ornamental flowering shrubs.

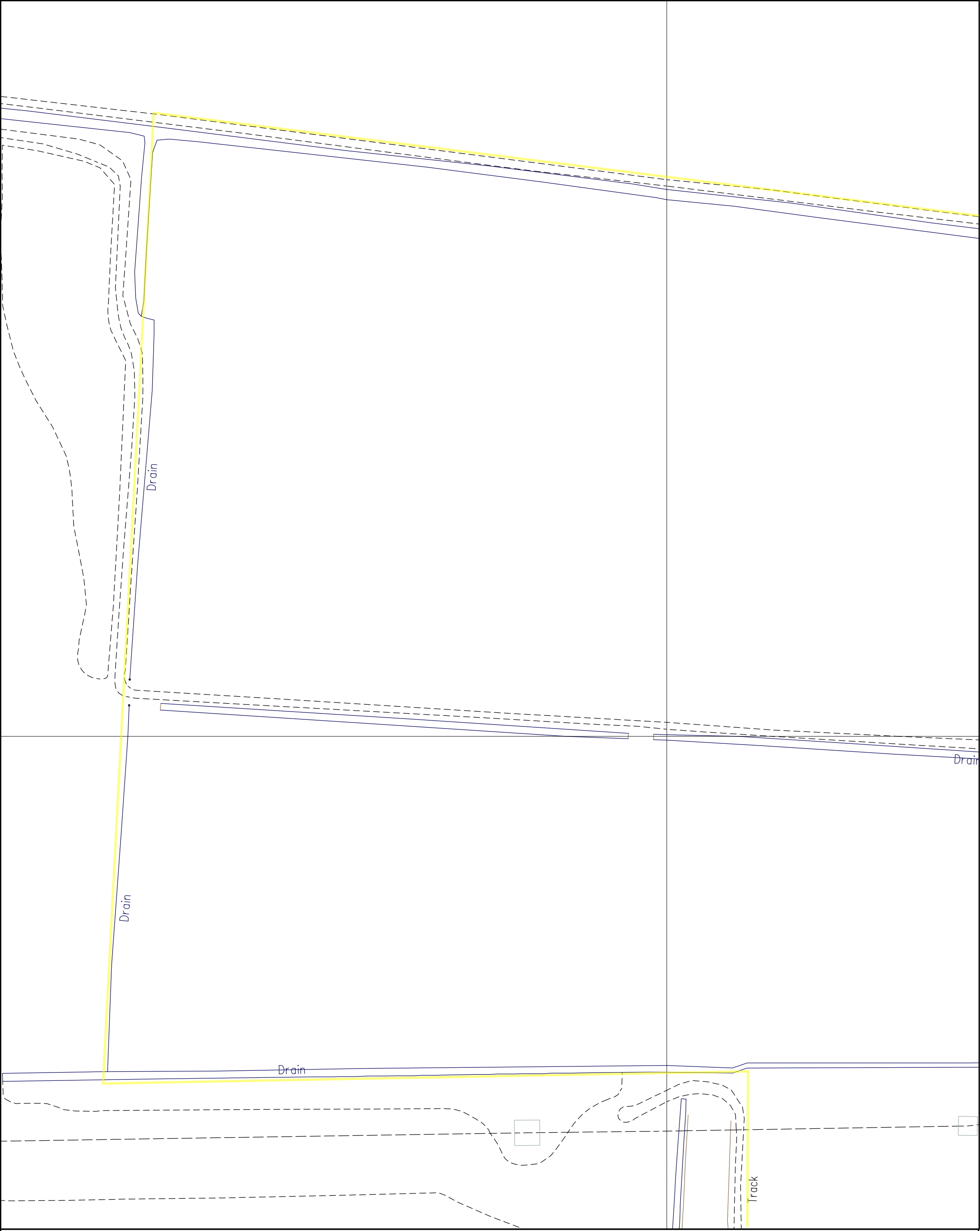

SCALE: 1 : 1250
 USER ID: joe.goodchild
 DATE: 09/10/2020
 EXTRACT DATE: 10/06/2020
 MAP REF: SE8112
 CENTRE: 481933, 412046

LP MAINS	
MP MAINS	
IP MAINS	
LHP MAINS	

This plan shows those pipes owned by Cadent Gas Ltd in their role as a Licensed Gas Transporter (GT). Gas pipes owned by other GTs, or otherwise privately owned, may be present in this area. Information with regard to such pipes should be obtained from the relevant owners. The information shown on this plan is given without warranty, the accuracy thereof cannot be guaranteed. Service pipes, valves, syphons, stub connections, etc. are not shown but their presence should be anticipated. No liability of any kind whatsoever is accepted by Cadent Gas Ltd or their agents, servants or contractors for any error or omission. Safe digging practices, in accordance with HS(G)47, must be used to verify and establish the actual position of mains, pipes, services and other apparatus on site before any mechanical plant is used. It is your responsibility to ensure that this information is provided to all persons (either direct labour or contractors) working for you on or near gas apparatus. The information included on this plan should not be referred to beyond a period of 28 days from the date of issue. Further information on all DR4s can be determined by calling the DR4 hotline on 01455 892426 (9am-5pm) A DR4 is where a potential error has been identified within the asset record and a process is currently underway to investigate and resolve the error as appropriate.

MAPS Viewer Version 5.8.0.1
 Local Machine



This plan is reproduced from or based on the OS map by Cadent Gas Ltd, with the sanction of the controller of HM Stationery Office. Crown Copyright Reserved.

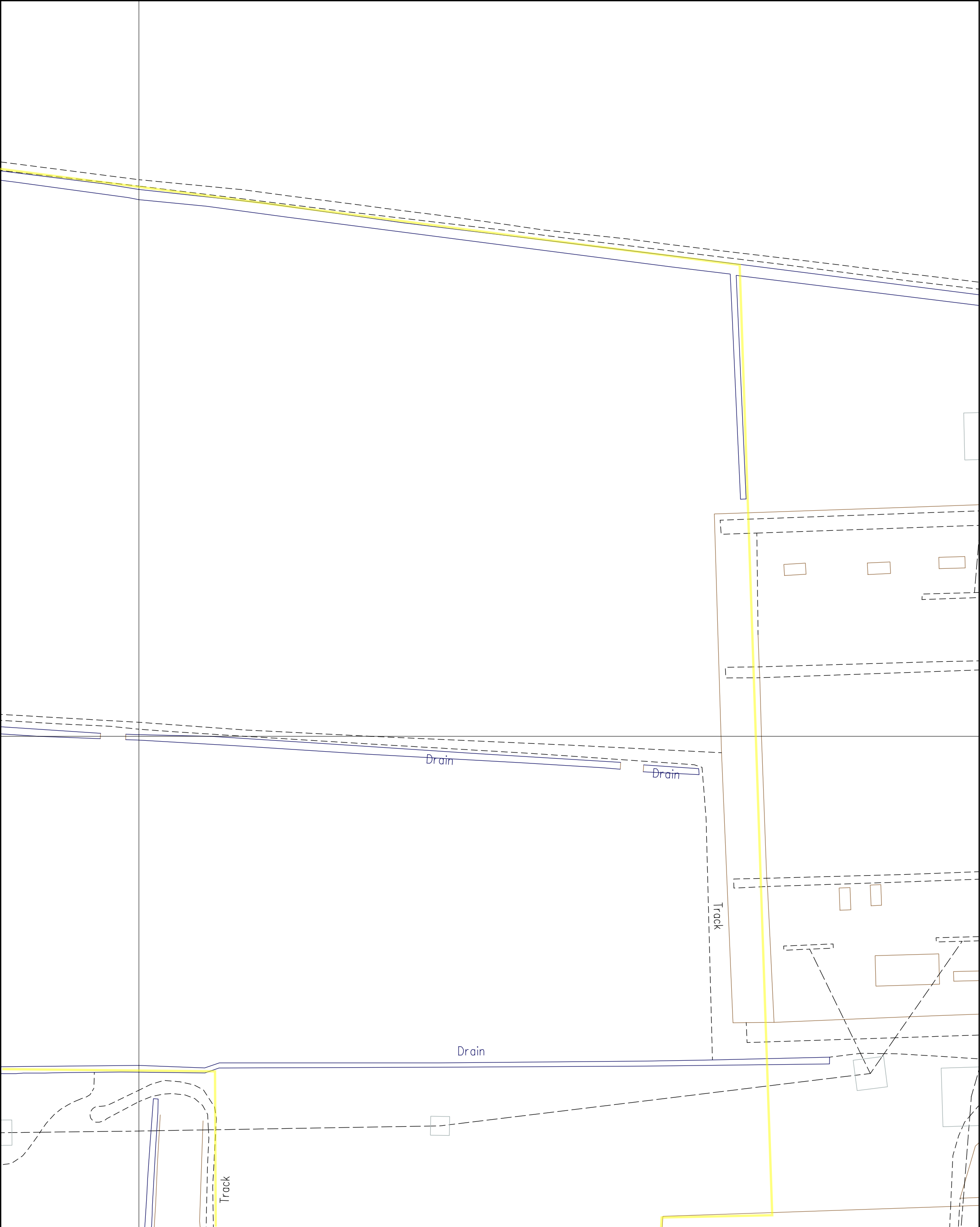

SCALE: 1 : 1250
 USER ID: joe.goodchild
 DATE: 09/10/2020
 EXTRACT DATE: 10/06/2020
 MAP REF: SE8212
 CENTRE: 482133, 412046

LP MAINS	
MP MAINS	
IP MAINS	
LHP MAINS	

This plan shows those pipes owned by Cadent Gas Ltd in their role as a Licensed Gas Transporter (GT). Gas pipes owned by other GTs, or otherwise privately owned, may be present in this area. Information with regard to such pipes should be obtained from the relevant owners. The information shown on this plan is given without warranty, the accuracy thereof cannot be guaranteed. Service pipes, valves, syphons, stub connections, etc. are not shown but their presence should be anticipated. No liability of any kind whatsoever is accepted by Cadent Gas Ltd or their agents, servants or contractors for any error or omission. Safe digging practices, in accordance with HS(G)47, must be used to verify and establish the actual position of mains, pipes, services and other apparatus on site before any mechanical plant is used. It is your responsibility to ensure that this information is provided to all persons (either direct labour or contractors) working for you on or near gas apparatus. The information included on this plan should not be referred to beyond a period of 28 days from the date of issue. Further information on all DR4s can be determined by calling the DR4 hotline on 01455 892426 (9am-5pm) A DR4 is where a potential error has been identified within the asset record and a process is currently underway to investigate and resolve the error as appropriate.

MAPS Viewer Version 5.8.0.1
 Local Machine

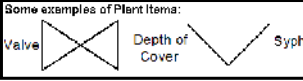

This plan is reproduced from or based on the OS map by Cadent Gas Ltd, with the sanction of the controller of HM Stationery Office. Crown Copyright Reserved.

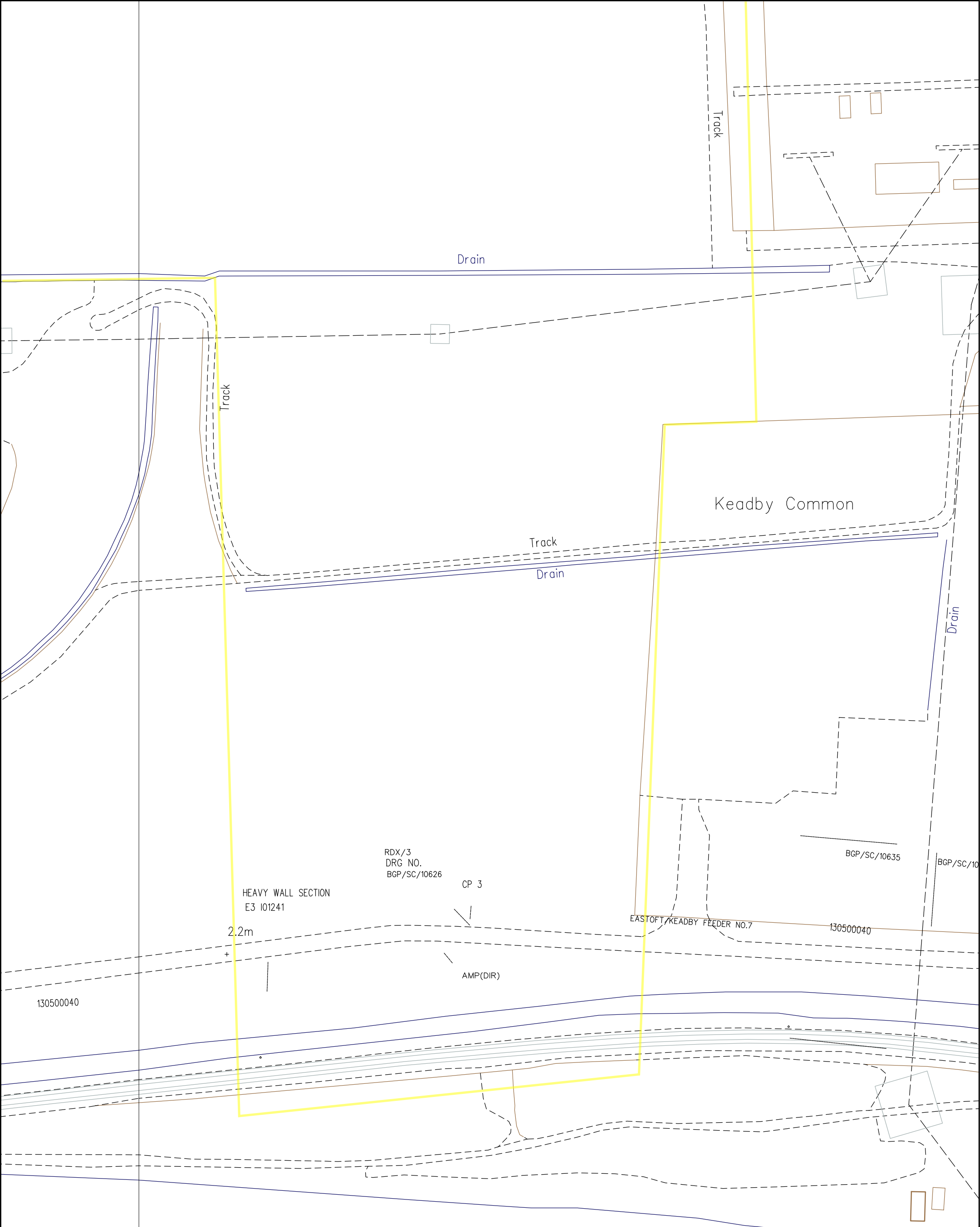

SCALE: 1 : 1250
 USER ID: joe.goodchild
 DATE: 09/10/2020
 EXTRACT DATE: 10/06/2020
 MAP REF: SE8211
 CENTRE: 482133, 411746

LP MAINS	
MP MAINS	
IP MAINS	
LHP MAINS	

This plan shows those pipes owned by Cadent Gas Ltd in their role as a Licensed Gas Transporter (GT). Gas pipes owned by other GTs, or otherwise privately owned, may be present in this area. Information with regard to such pipes should be obtained from the relevant owners. The information shown on this plan is given without warranty, the accuracy thereof cannot be guaranteed. Service pipes, valves, syphons, stub connections, etc. are not shown but their presence should be anticipated. No liability of any kind whatsoever is accepted by Cadent Gas Ltd or their agents, servants or contractors for any error or omission. Safe digging practices, in accordance with HS(G)47, must be used to verify and establish the actual position of mains, pipes, services and other apparatus on site before any mechanical plant is used. It is your responsibility to ensure that this information is provided to all persons (either direct labour or contractors) working for you on or near gas apparatus. The information included on this plan should not be referred to beyond a period of 28 days from the date of issue. Further information on all DR4s can be determined by calling the DR4 hotline on 01455 892426 (9am-5pm) A DR4 is where a potential error has been identified within the asset record and a process is currently underway to investigate and resolve the error as appropriate.

MAPS Viewer Version 5.8.0.1
 Local Machine

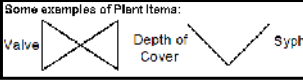

This plan is reproduced from or based on the OS map by Cadent Gas Ltd, with the sanction of the controller of HM Stationery Office. Crown Copyright Reserved.

Maps by email Plant Information Reply

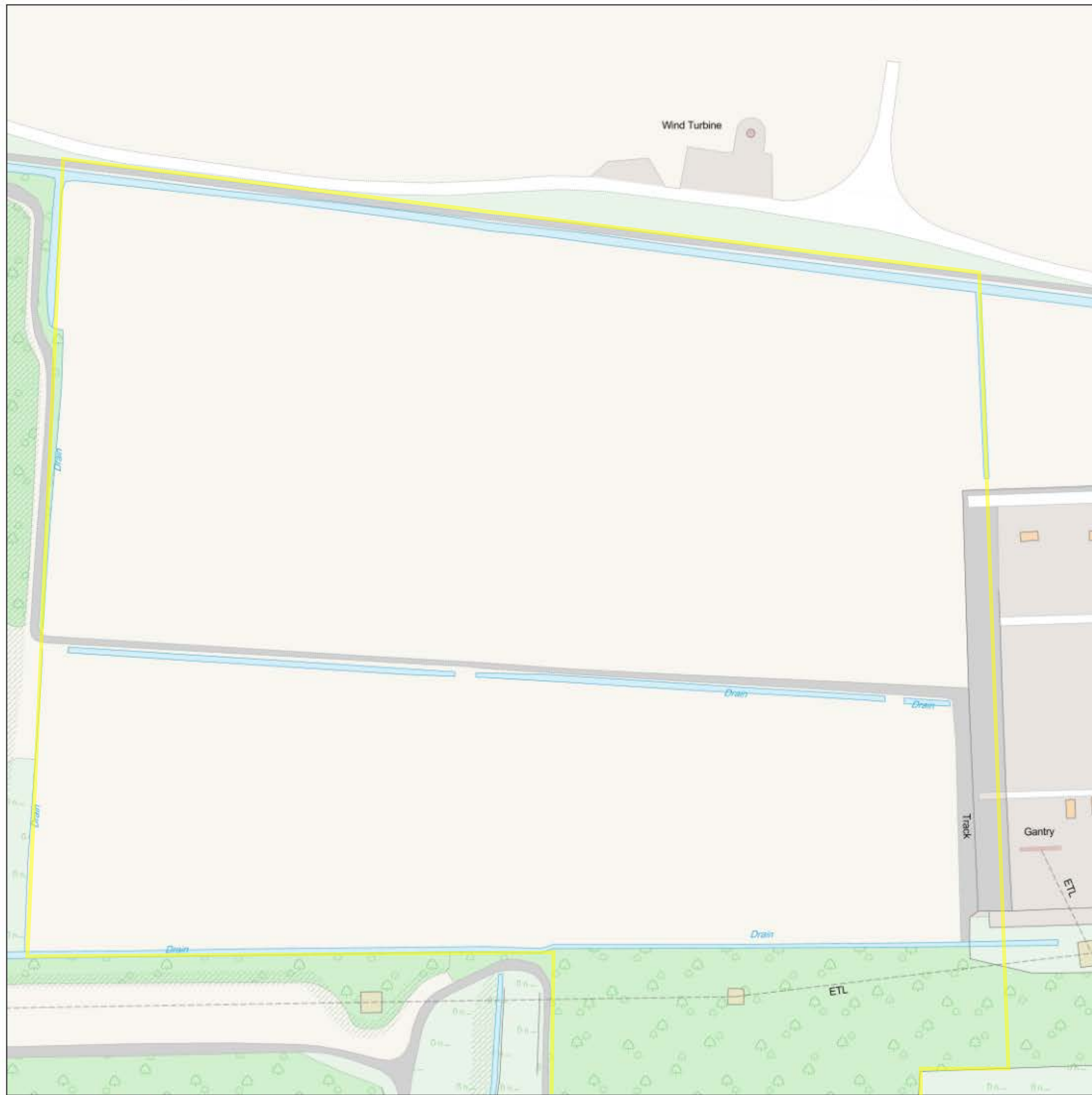

IMPORTANT WARNING

Information regarding the location of BT apparatus is given for your assistance and is intended for general guidance only. No guarantee is given of its accuracy. It should not be relied upon in the event of excavations or other works being made near to BT apparatus which may exist at various depths and may deviate from the marked route.



openreach

CLICK BEFORE YOU DIG

FOR PROFESSIONAL FREE ON SITE ASSISTANCE PRIOR TO COMMENCEMENT OF EXCAVATION WORKS INCLUDING LOCATE AND MARKING SERVICE

email cbyd@openreach.co.uk

ADVANCE NOTICE REQUIRED
(Office hours: Monday - Friday 08.00 to 17.00)
www.openreach.co.uk/cbyd

Accidents happen

If you do damage any Openreach equipment please let us know by calling 0800 023 2023 (opt 1 + opt 1) and we can get it fixed ASAP

KEY TO BT SYMBOLS

	Planned	Live	Change Of State	+	Hatchings	
PCP			Split Coupling	×	Built	
Pole			Duct Tee	▲	Planned	
Box			Building		Inferred	
Manhole			Kiosk		Duct	
Cabinet			Other proposed plant is shown using dashed lines. BT Symbols not listed above may be disregarded. Existing BT Plant may not be recorded. Information valid at time of preparation. Maps are only valid for 90 days after the date of publication.			
	Pending Add	In Place	Pending Remove	Not In Use		
Power Cable						
Power Duct				N/A		

BT Ref : PRL100260

Map Reference : (centre) SE8203012057

Easting/Northing : (centre) 482030,412057

Issued : 15/10/2020 10:02:42

Reproduced from the Ordnance Survey map by BT by permission of Ordnance Survey on behalf of the Controller of Her Majesty's Stationary Office
(C) Crown Copyright British Telecommunications plc 100028040

WARNING: IF PLANNED WORKS FALL INSIDE HATCHED AREA IT IS ESSENTIAL BEFORE PROCEEDING THAT YOU CONTACT THE NATIONAL NOTICE HANDLING CENTRE. PLEASE SEND E-MAIL TO: nnhc@openreach.co.uk

Maps by email Plant Information Reply

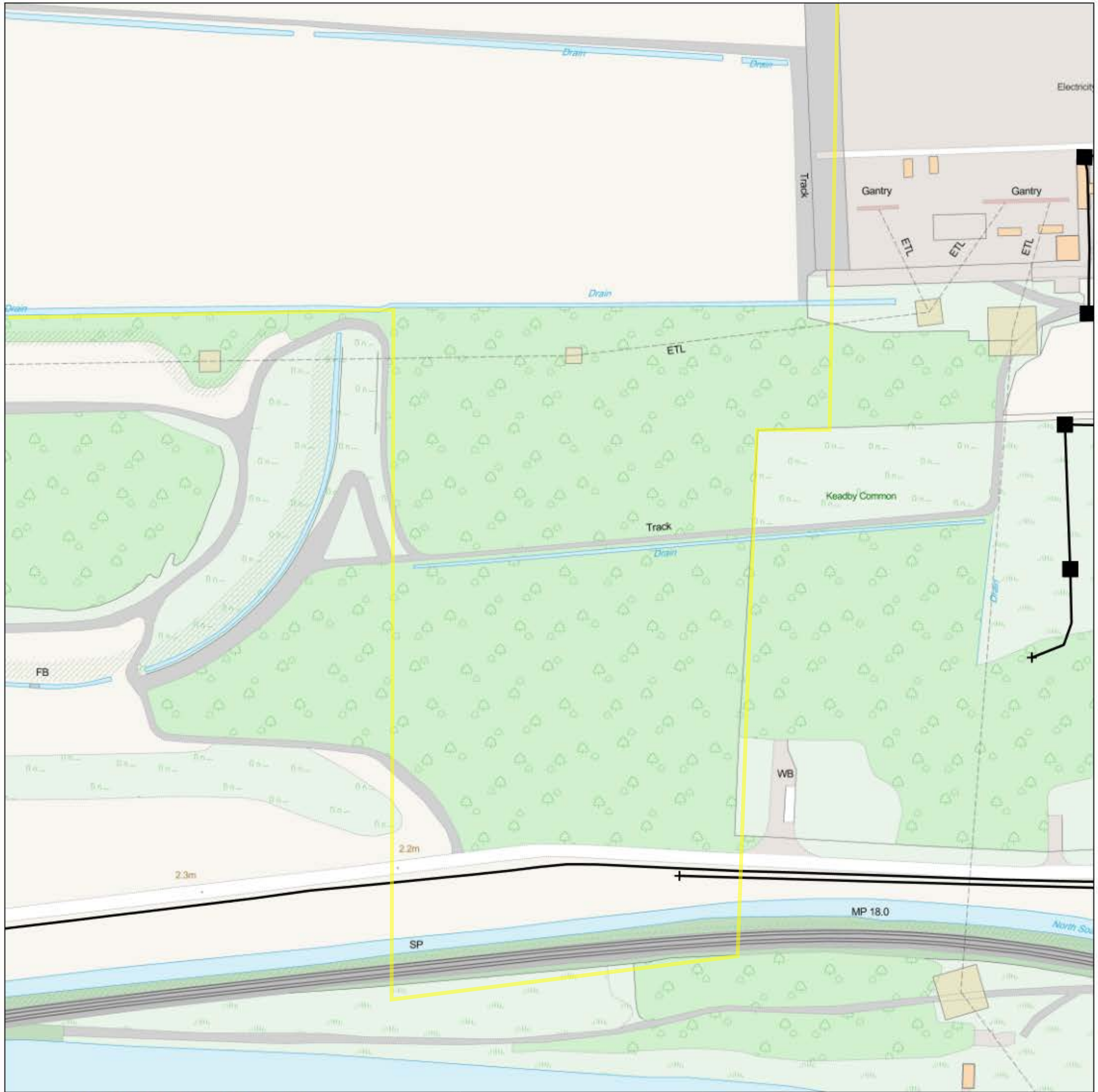

IMPORTANT WARNING

Information regarding the location of BT apparatus is given for your assistance and is intended for general guidance only. No guarantee is given of its accuracy. It should not be relied upon in the event of excavations or other works being made near to BT apparatus which may exist at various depths and may deviate from the marked route.



openreach

CLICK BEFORE YOU DIG

FOR PROFESSIONAL FREE ON SITE ASSISTANCE PRIOR TO COMMENCEMENT OF EXCAVATION WORKS INCLUDING LOCATE AND MARKING SERVICE

email cbyd@openreach.co.uk

ADVANCE NOTICE REQUIRED
(Office hours: Monday - Friday 08.00 to 17.00)
www.openreach.co.uk/cbyd

Accidents happen

If you do damage any Openreach equipment please let us know by calling 0800 023 2023 (opt 1 + opt 1) and we can get it fixed ASAP

KEY TO BT SYMBOLS		Change Of State	+	Hatchings	
	<i>Planned</i>	<i>Live</i>	×	Built	
PCP			▲	Planned	
Pole			■	Inferred	
Box			Ⓚ	Duct	
Manhole			Other proposed plant is shown using dashed lines. BT Symbols not listed above may be disregarded. Existing BT Plant may not be recorded. Information valid at time of preparation. Maps are only valid for 90 days after the date of publication.		
Cabinet					
	<i>Pending Add</i>	<i>In Place</i>	<i>Pending Remove</i>	<i>Not In Use</i>	
Power Cable					
Power Duct				N/A	

Reproduced from the Ordnance Survey map by BT by permission of Ordnance Survey on behalf of the Controller of Her Majesty's Stationary Office
(C) Crown Copyright British Telecommunications plc 100028040

BT Ref : NTW12078C
Map Reference : (centre) SE8210311764
Easting/Northing : (centre) 482103,411764
Issued : 09/10/2020 12:07:24

WARNING: IF PLANNED WORKS FALL INSIDE HATCHED AREA IT IS ESSENTIAL BEFORE PROCEEDING THAT YOU CONTACT THE NATIONAL NOTICE HANDLING CENTRE. PLEASE SEND E-MAIL TO: nnhc@openreach.co.uk



Premier Energy Services Ltd
Premier House
Daux Road
Billingshurst
West Sussex
RH14 9SJ

Virgin Media
Field Services
Units 1-12
Broad Lane
Mayfair Business Park
Bradford
Yorkshire
BD4 8PW

Tel: 0870 888 3116 Opt 2
Fax: 01268 468557

Plant Enquiry Ref: VM.1175268
Your Letter Date: 16.10.2020
Your Ref: NA
Date: 19.10.2020

Dear Sir /Madam

Enquiry Location:

Keady Power Station West DN17 3ER

Thank you for your enquiry regarding work at the above location.

Virgin Media and Viatel plant should not be affected by your proposed work and no strategic additions to our existing network are envisaged in the immediate future.

Should your request be in relation to a Residential New Development, Virgin Media would like the opportunity to assist with your diversionary quote and serve your site free of charge, offering your customers the fastest widely available broadband speeds on the market up to 500Mbps.

For Commercial New Developments our team can also be reached through the below link, ensuring future businesses to your site are connected to our fibre network.

Simply head over to www.virginmedia.com/developer and fill in the enquiry form and a member of our New Developments team will be in touch within 48 hours.

You will also find useful information about additional benefits to you and your site, plus a handy 'developers guide' can be downloaded with detailed installation requirements.

Or if you prefer to talk, please call the New Developments team on: 0800 408 0088 Option 2
Yours faithfully,

National Plant Enquiries Team

Email: plant.enquiries.team@virginmedia.co.uk

Please note: National Plant Enquiries Team (Bradford) cover and respond to plant enquiries for all ex ntl: Telewest franchise areas.

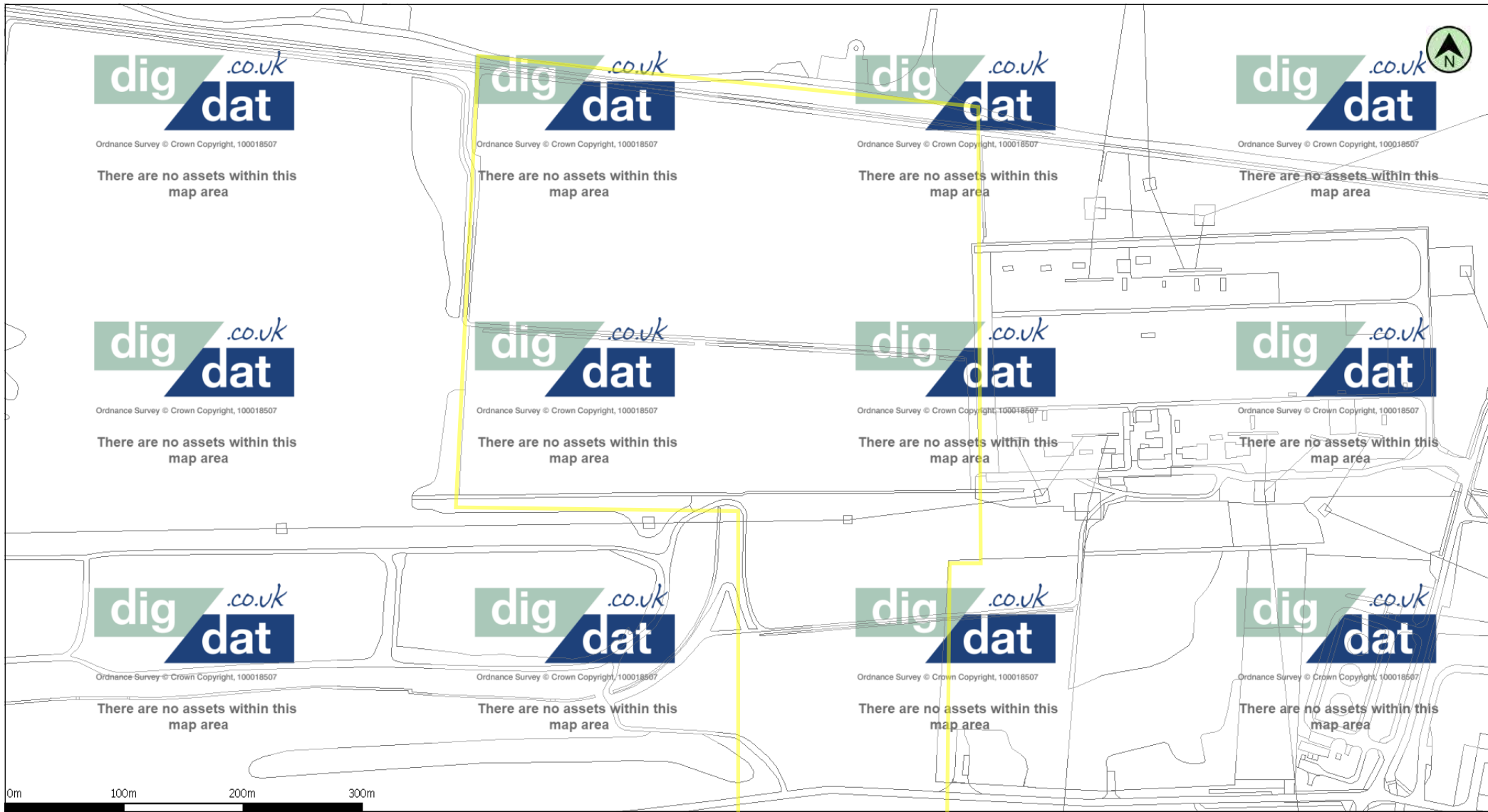

(c) Crown copyright and database rights 2020 Ordnance Survey 100019209 Date: 19/10/20 Scale: 1:4523 Map Centre: 482033,411946 Data updated: 01/10/20 Telecoms Plan A4

Important Information - please read The purpose of this plan is to identify Virgin Media apparatus. We have tried to make it as accurate as possible but we cannot warrant its accuracy. In addition, we caution that within Virgin Media apparatus there may be instances where mains voltage power cables have been placed inside green, rather than black ducting. Further details can be found using the "Affected Postcodes.pdf", which can be downloaded from this website. Therefore, you must not rely solely on this plan if you are carrying out any excavation or other works in the vicinity of Virgin Media apparatus. The actual position of any underground service must be verified by cable detection equipment, etc. and established on site before any mechanical plant is used. Accordingly, unless it is due to the negligence of Virgin Media, its employees or agents, Virgin Media will not have any liability for any omissions or inaccuracies in the plan or for any loss or damage caused or arising from the use of and/or any reliance on this plan. This plan is produced by Virgin Media Limited (c) Crown copyright and database rights 2020 Ordnance Survey 100019209.

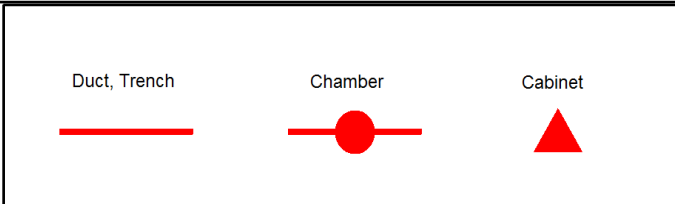

alasonjennifer.nathan@virginmedia.co
VM.1175268



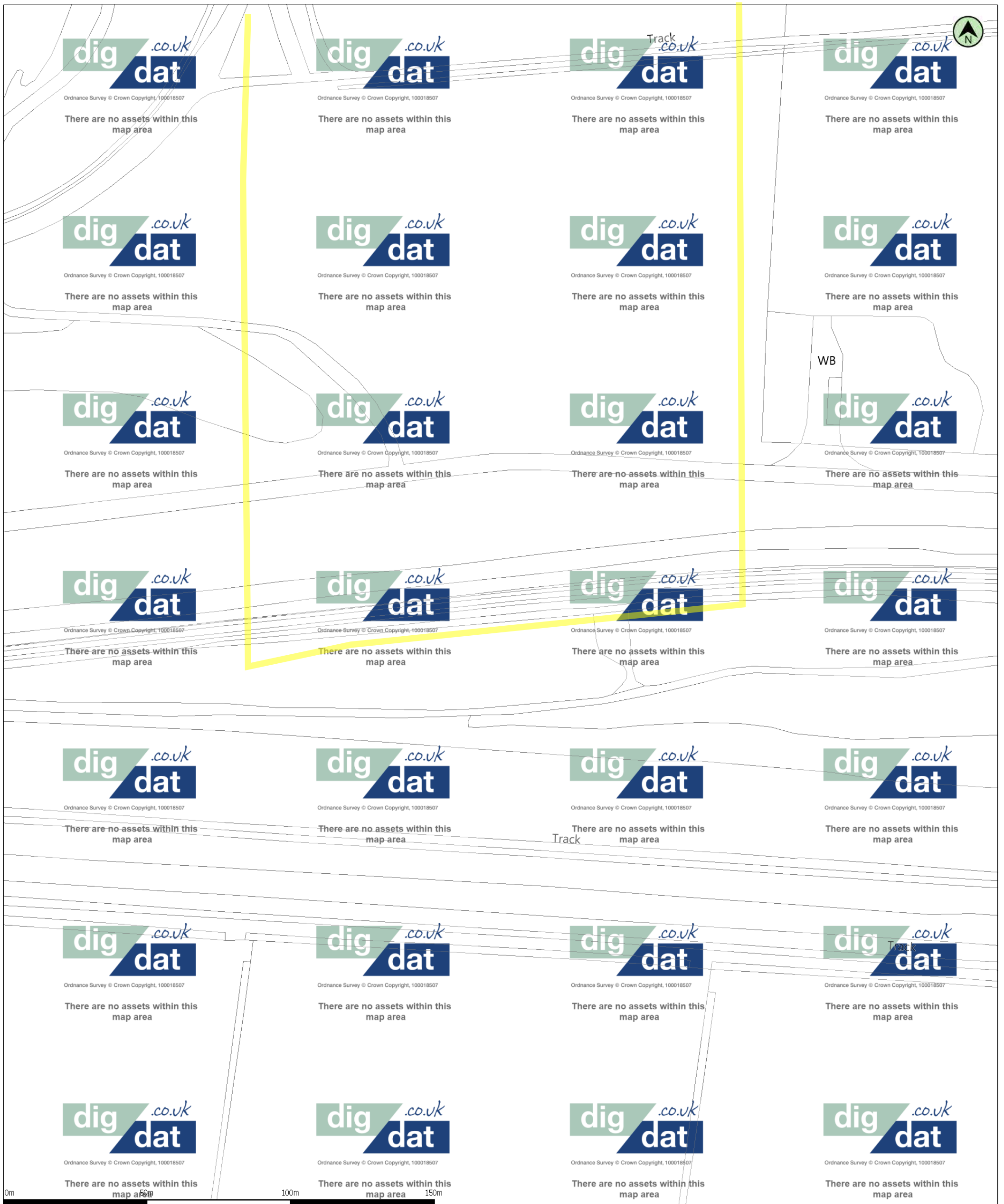

(c) Crown copyright and database rights 2020 Ordnance Survey 100019209
 Data updated: 01/10/20

Scale: 1:1250
 Map Centre: 482097,411575

Date: 26/10/20
 Our Ref: 451369 - 1

Telecoms Plan A3
 Powered by digdat

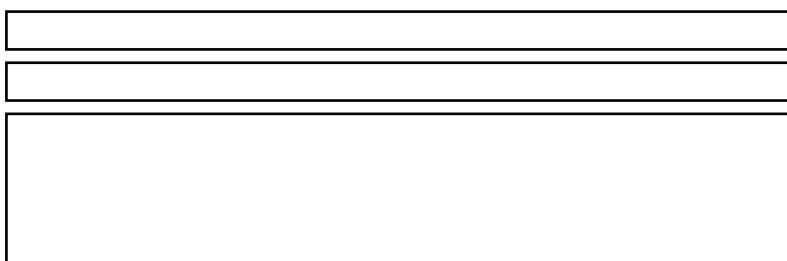
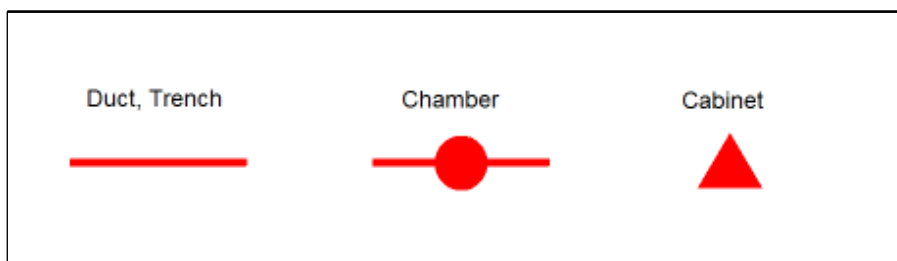

Important Information - please read The purpose of this plan is to identify Virgin Media apparatus. We have tried to make it as accurate as possible but we cannot warrant its accuracy. In addition, we caution that within Virgin Media apparatus there may be instances where mains voltage power cables have been placed inside green, rather than black ducting. Further details can be found using the "Affected Postcodes.pdf", which can be downloaded from this website. Therefore, you must not rely solely on this plan if you are carrying out any excavation or other works in the vicinity of Virgin Media apparatus. The actual position of any underground service must be verified by cable detection equipment, etc. and established on site before any mechanical plant is used. Accordingly, unless it is due to the negligence of Virgin Media, its employees or agents, Virgin Media will not have any liability for any omissions or inaccuracies in the plan or for any loss or damage caused or arising from the use of and/or any reliance on this plan. This plan is produced by Virgin Media Limited (c) Crown copyright and database rights 2020 Ordnance Survey 100019209.

Joe Goodchild

From: plantenquiryservice@gtc-uk.co.uk
Sent: 09 October 2020 13:49
To: Joe Goodchild
Subject: GTC Plant Enquiry - Ref- 1533314
Attachments: 1533314.png

GTC Apparatus Not Found In Search Area

Our Plant Enquiry Service Ref: 1533314
Your Enquiry Ref: 607277 - Keady Power

Dear Joe,

Thank you for your enquiry concerning apparatus in the vicinity of your proposed work. GTC can confirm that we have no apparatus in the vicinity but please note that other asset owners may have and ensure all utility owners have been consulted. For your records, the search area is shown in the attached map.

Please note our assets now include those owned and operated by:

- GTC Pipelines Limited
- Independent Pipelines Limited
- Quadrant Pipelines Limited
- Electricity Network Company Limited
- Independent Power Networks Limited
- Independent Water Networks Limited
- Open Fibre Networks Limited
- Independent Community Heating Limited

If you have any queries or require any further information please do not hesitate to contact us.

Your sincerely,

GTC Plant Enquiry Service.

GTC
Synergy House
Woolpit Business Park
Woolpit
Bury St Edmunds
Suffolk, IP30 9UP
Tel: 01359 240363
plant.enquiries@gtc-uk.co.uk

NOTE:

This E-Mail originates from GTC, Synergy House, Woolpit Business Park, Woolpit, Bury St Edmunds, Suffolk, IP30 9UP
VAT Number: GB688 8971 40. Registered No: 029431.

DISCLAIMER

The information in this E-Mail and in any attachments is confidential and may be privileged. If you are not the intended recipient, please destroy this message, delete any copies held on your system and notify the sender immediately. You

Joe Goodchild

From: Plant Enquiries <plantenquiries@lastmile-uk.com>
Sent: 09 October 2020 14:59
To: Joe Goodchild
Subject: RE: Plant Enquiry - Keady Power Station West

Dear Sir/Madam,

Thank you for submitting your recent plant enquiry.

Based on the information provided, I can confirm that Last Mile **does not** have any plant within the area(s) specified in your request.

If you require further assistance with outstanding enquiries, please call 03300 587 443.

Please ensure all plant enquiries are sent to plantenquiries@lastmile-uk.com

Regards

From: Joe Goodchild <joe.goodchild@premierenergy.co.uk>
Sent: 09 October 2020 12:53
To: Plant Enquiries <plantenquiries@lastmile-uk.com>
Subject: Plant Enquiry - Keady Power Station West

Dear Plant Enquiries,

Please search the following location for your plant:

Bonnyhale Road, Keadby, North Lincolnshire, DN17 3ER

[482033,411946]

A location plan (2 pages) showing the search area is attached. If you have plant within the search area or close to the boundary please provide record drawings, ideally by email attachment. Please provide your information as soon as possible.

Many thanks.

Kind regards,

Joe Goodchild

Utility Searches

01403 740240 | joe.goodchild@premierenergy.co.uk



Premier House, Daux Road, Billingshurst, West Sussex, RH14 9SJ
www.premierenergy.co.uk



Enquirer

Name	Mr Joe Goodchild	Phone	01403289849
Company	Premier Energy	Mobile	Not Supplied
Address	Premier House Daux road Billingshurst West Sussex RH14 9SJ		
Email	joe.goodchild@premierenergy.co.uk		

Enquiry Details

Scheme/Reference	607277 - Keady Power Station West		
Enquiry type	Initial Enquiry	Work category	Development Projects
Start date	10/11/2020	Work type	Housing
End date	10/11/2020	Site size	214522 metres square
Searched location	XY= 482033, 411946	Work type buffer*	25 metres
Confirmed location	482014 412027		
Site Contact Name	Not Supplied	Site Phone No	Not Supplied
Description of Works			

* The WORK TYPE BUFFER is a distance added to your search area based on the Work type you have chosen.

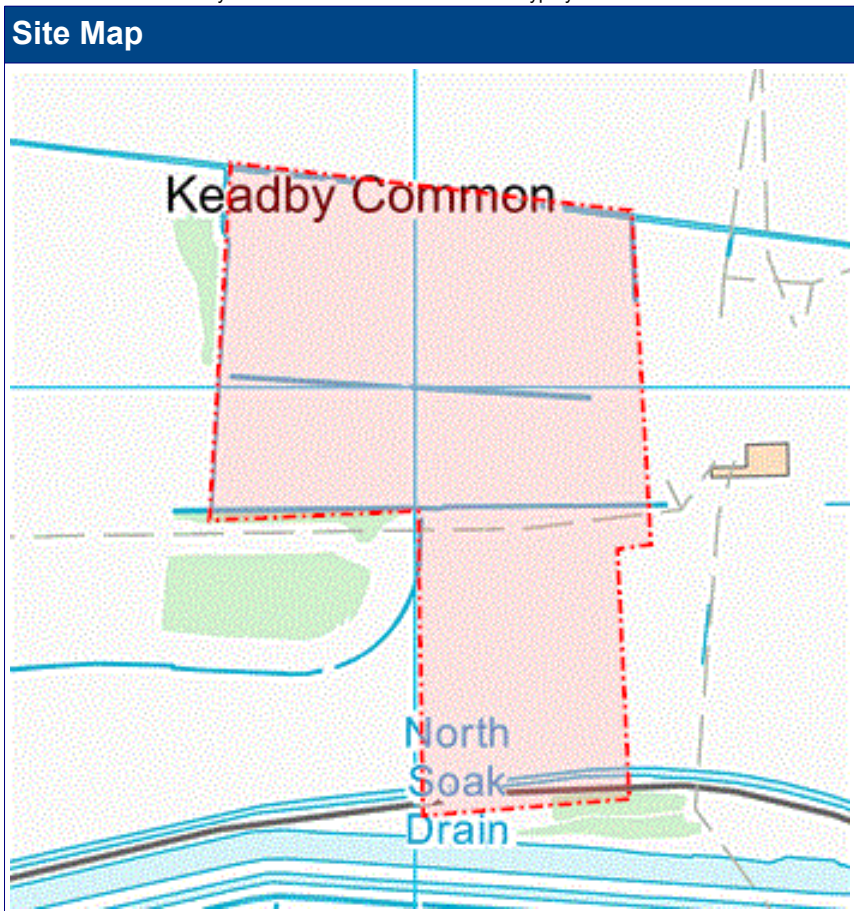

Asset Owners

Terms and Conditions. Please note that this enquiry is subject always to our standard terms and conditions available at www.linesearchbeforeudig.co.uk ("Terms of Use") and the disclaimer at the end of this document. Please note that in the event of any conflict or ambiguity between the terms of this Enquiry Confirmation and the Terms of Use, the Terms of Use shall take precedence.

Notes. Please ensure your contact details are correct and up to date on the system in case the LSBUD Members need to contact you.

Validity and search criteria. The results of this enquiry are based on the confirmed information you entered and are valid only as at the date of the enquiry. It is your responsibility to ensure that the Enquiry Details are correct, and LineSearchbeforeUdig accepts no responsibility for any errors or omissions in the Enquiry Details or any consequences thereof. LSBUD Members update their asset information on a regular basis so you are advised to consider this when undertaking any works. It is your responsibility to choose the period of time after which you need to resubmit any enquiry but the maximum time (after which your enquiry will no longer be dealt with by the LSBUD Helpdesk and LSBUD Members) is 28 days. If any details of the enquiry change, particularly including, but not limited to, the location of the work, then a further enquiry must be made.

Asset Owners & Responses. Please note the enquiry results include the following:

1. "LSBUD Members" who are asset owners who have registered their assets on the LSBUD service.
2. "Non LSBUD Members" are asset owners who have not registered their assets on the LSBUD service but LSBUD is aware of their existence. Please note that there could be other asset owners within your search area.

Below are three lists of asset owners:

1. **LSBUD Members who have assets registered within your search area. ("Affected")**
 - a. These LSBUD Members will either:
 - i. Ask for further information ("Email Additional Info" noted in status). The additional information includes: Site contact name and number, Location plan, Detailed plan (minimum scale 1:2500), Cross sectional drawings (if available), Work Specification.
 - ii. Respond directly to you ("Await Response"). In this response they may either send plans directly to you or ask for further information before being able to do so, particularly if any payments or authorisations are required.
2. **LSBUD Members who do not have assets registered within your search area. ("Not Affected")**
3. **Non LSBUD Members who may have assets within your search area.** Please note that this list is not exhaustive and all details are provided as a guide only. It is your responsibility to identify and consult with all asset owners before proceeding.

National Grid. Please note that the LSBUD service only contains information on National Grid's Gas above 7 bar asset, all National Grid Electricity Transmission assets and National Grid's Gas Distribution Limited above 2 bar asset.

For National Grid Gas Distribution Ltd below 2 bar asset information please go to www.beforeyoudig.nationalgrid.com

LSBUD Members who have assets registered on the LSBUD service within the vicinity of your search area.

List of affected LSBUD members

Asset Owner	Phone/Email	Emergency Only	Status
National Grid Gas (Above 7 bar), National Grid Gas Distribution Limited (Above 2 bar) and National Grid Electricity Transmission	0800688588 plantprotection@cadentgas.com	Gas 0800111999 Electricity 0800404090	Email Additional Info

LSBUD Members who do not have assets registered on the LSBUD service within the vicinity of your search area. Please be aware that LSBUD Members make regular changes to their assets and this list may vary for new enquiries in the same area.

List of not affected LSBUD members

AWE Pipeline	Balfour Beatty Investments Limited	BOC Limited (A Member of the Linde Group)
BP Exploration Operating Company Limited	BPA	Carrington Gas Pipeline
CATS Pipeline c/o Wood Group PSN	Cemex	Centrica Storage Ltd
Chrysaor Production (UK) Limited	CLH Pipeline System Ltd	CNG Services Ltd
Concept Solutions People Ltd	ConocoPhillips (UK) Teesside Operator Ltd	Diamond Transmission Corporation
DIO (MOD Abandoned Pipelines)	DIO (MOD Live Pipelines)	Drax Group
E.ON UK CHP Limited	EirGrid	Electricity North West Limited
ENI & Himor c/o Penspen Ltd	EnQuest NNS Limited	EP Langage Limited
ESP Utilities Group	ESSAR	Esso Petroleum Company Limited
Fulcrum Pipelines Limited	Gamma	Gas Networks Ireland (UK)
Gateshead Energy Company	Gigaclear Ltd	Gtt
Heathrow Airport LTD	Humbly Grove Energy	IGas Energy
INEOS FPS Pipelines	INEOS Manufacturing (Scotland and TSEP)	INOVYN Enterprises Limited
Intergen (Coryton Energy or Spalding Energy)	Jurassic Fibre Ltd	Mainline Pipelines Limited
Manchester Jetline Limited	Manx Cable Company	Marchwood Power Ltd (Gas Pipeline)
Melbourn Solar Limited	Murphy Utility Assets	Northumbrian Water Group
NPower CHP Pipelines	NYnet Ltd	Oikos Storage Limited
Ørsted	Perenco UK Limited (Purbeck Southampton Pipeline)	Petroineos
Phillips 66	Portsmouth Water	Premier Transmission Ltd (SNIP)
Redundant Pipelines - LPDA	RWE - Great Yarmouth Pipeline (Bacton to Great Yarmouth Power Station)	RWEnpower (Little Barford and South Haven)
SABIC UK Petrochemicals	Scottish and Southern Electricity Networks	Scottish Power Generation
Seabank Power Ltd	SES Water	SGN
Shell	Shell NOP	SSE (Peterhead Power Station)
SSE Enterprise Telecoms	SSE Generation Ltd	SSE Utility Solutions Limited
Tata Communications (c/o JSM Construction Ltd)	Total (Colnbrook & Colwick Pipelines)	Total Finaline Pipelines
Transmission Capital	UK Power Networks	Uniper UK Ltd
University of Cambridge Granta Backbone	Vattenfall	Veolia ES SELCHP Limited

Network

Veolia ES Sheffield Ltd

Wales and West Utilities

West of Duddon Sands Transmission Ltd

Western Power Distribution

Westminster City Council

Zayo Group UK Ltd c/o JSM Group Ltd

Joe Goodchild
Premier Energy Services
Premier House
Daux Road
Billingshurst
Billingshurst
West Sussex
RH14 9SJ

Plant Protection
Cadent
Block 1; Floor 1
Brick Kiln Street
Hinckley
LE10 0NA
E-mail: plantprotection@cadentgas.com
Telephone: +44 (0)800 688588

National Gas Emergency Number:
0800 111 999*

National Grid Electricity Emergency Number:
0800 40 40 90*

* Available 24 hours, 7 days/week.
Calls may be recorded and monitored.

www.cadentgas.com

Date: 09/10/2020

Our Ref: EM_GE1A_3SWX_733897

Your Ref: 607277 - Keady Power Station West

RE: Proposed Works, Bonnyhale Road, Keadby, North Lincolnshire, DN17 3ER

Thank you for your enquiry which was received on 09/10/2020.
Please note this response and any attached map(s) are valid for 28 days.

An assessment has been carried out with respect to Cadent Gas Limited, National Grid Electricity Transmission plc's and National Grid Gas Transmission plc's apparatus. Please note it does not cover the items listed in the section "Your Responsibilities and Obligations", including gas service pipes and related apparatus.

For details of Network areas please see the Cadent website (<http://cadentgas.com/Digging-safely/Dial-before-you-dig>) or the enclosed documentation.

As your works are at a "proposed" stage, any maps and guidance provided are for information purposes only. This is not approval to commence work. You must submit a "Scheduled Works" enquiry at the earliest opportunity and failure to do this may lead to disruption to your plans and works. Plant Protection will endeavour to provide an initial assessment within 14 days of receipt of a Scheduled Works enquiry and dependent on the outcome of this, further consultation may be required.

In any event, for safety and legal reasons, works must not be carried out until a Scheduled Works enquiry has been completed and final response received.

Your Responsibilities and Obligations

The "Assessment" Section below outlines the detailed requirements that must be followed when planning or undertaking your scheduled activities at this location.

It is your responsibility to ensure that the information you have submitted is accurate and that all relevant documents including links are provided to all persons (either direct labour or contractors) working for you near Cadent and/or National Grid's apparatus, e.g. as contained within the Construction (Design and Management) Regulations.

This assessment solely relates to Cadent Gas Limited, National Grid Electricity Transmission plc (NGET) and National Grid Gas Transmission plc (NGGT) and apparatus. This assessment does **NOT** include:

- | Cadent and/or National Grid's legal interest (easements or wayleaves) in the land which restricts activity in proximity to Cadent and/or National Grid's assets in private land. You must obtain details of any such restrictions from the landowner in the first instance and if in doubt contact Plant Protection.
- | Gas service pipes and related apparatus
- | Recently installed apparatus
- | Apparatus owned by other organisations, e.g. other gas distribution operators, local electricity companies, other utilities, etc.

It is **YOUR** responsibility to take into account whether the items listed above may be present and if they could be affected by your proposed activities. Further "Essential Guidance" in respect of these items can be found on either the [National Grid](#) or [Cadent](#) website.

This communication does not constitute any formal agreement or consent for any proposed development work; either generally or with regard to Cadent and/or National Grid's easements or wayleaves nor any planning or building regulations applications.

Cadent Gas Limited, NGGT and NGET or their agents, servants or contractors do not accept any liability for any losses arising under or in connection with this information. This limit on liability applies to all and any claims in contract, tort (including negligence), misrepresentation (excluding fraudulent misrepresentation), breach of statutory duty or otherwise. This limit on liability does not exclude or restrict liability where prohibited by the law nor does it supersede the express terms of any related agreements.

If you require further assistance please contact the Plant Protection team via e-mail ([click here](#)) or via the contact details at the top of this response.

Yours faithfully

Plant Protection Team

ASSESSMENT

Affected Apparatus

The apparatus that has been identified as being in the vicinity of your proposed works is:

- | National Gas Transmission Pipelines and associated equipment
- | Electricity Transmission underground cables and associated equipment
- | Electricity Transmission overhead lines
- | Above ground electricity sites and installations

Requirements

BEFORE carrying out any work you must:

- | **Refer to the attached cable profile drawings (if any) which provide details about the location of National Grid's high voltage underground cables.**
- | Carefully read these requirements including the attached guidance documents and maps showing the location of apparatus.
- | Contact the landowner and ensure any proposed works in private land do not infringe Cadent and/or National Grid's legal rights (i.e. easements or wayleaves). If the works are in the road or footpath the relevant local authority should be contacted.
- | Ensure that all persons, including direct labour and contractors, working for you on or near Cadent and/or National Grid's apparatus follow the requirements of the HSE Guidance Notes HSG47 - 'Avoiding Danger from Underground Services' and GS6 – 'Avoidance of danger from overhead electric power lines'. This guidance can be downloaded free of charge at <http://www.hse.gov.uk>
- | In line with the above guidance, verify and establish the actual position of mains, pipes, cables, services and other apparatus on site before any activities are undertaken.

GUIDANCE

High Pressure Gas Pipelines Guidance:

If working in the vicinity of a high pressure gas pipeline the following document must be followed: 'Specification for Safe Working in the Vicinity of Cadent and/or National Grid High Pressure Gas Pipelines and Associated Installations - Requirements for Third Parties' (SSW22). This can be obtained from: <http://www2.nationalgrid.com/WorkArea/DownloadAsset.aspx?id=33968>

National High Pressure Gas Pipelines Guidance:

<http://www.nationalgrid.com/NR/rdonlyres/9934F173-04D0-48C4-BE4D-82294822D29C/51893/Above7barGasGuidance.pdf>

Dial Before You Dig Pipelines Guidance:

<http://www2.nationalgrid.com/WorkArea/DownloadAsset.aspx?id=33969>

Working Near National Grid Electricity Transmission equipment:

If you are carrying out any work in proximity to an overhead line or any excavation that may be near an underground cable then please consult National Grid Technical Guidance Note 287 that can be found at https://www.nationalgrid.com/sites/default/files/documents/8589935533-TGN%20287_Third%20party%20guidance%20for%20working%20near%20NGET%20equipment.pdf Further guidance related to underground cables can also be found at <https://www.nationalgrid.com/sites/default/files/documents/8589936512-Excavating%20Safety%20Leaflet%20Electricity.pdf>

Standard Guidance

Essential Guidance document:

<http://www2.nationalgrid.com/WorkArea/DownloadAsset.aspx?id=8589934982>

General Guidance document:

<http://www2.nationalgrid.com/WorkArea/DownloadAsset.aspx?id=35103>

Excavating Safely in the vicinity of gas pipes guidance (Credit card):

<http://www.nationalgrid.com/NR/rdonlyres/A3D37677-6641-476C-9DDA-E89949052829/44257/ExcavatingSafelyCreditCard.pdf>

Excavating Safely in the vicinity of electricity cables guidance (Credit card):

<http://www.nationalgrid.com/NR/rdonlyres/35DDEC6D-D754-4BA5-AF3C-D607D05A25C2/44858/ExcavatingSafelyCreditCardelectricitycables.pdf>

Copies of all the Guidance Documents can also be downloaded from the [National Grid](#) and [Cadent](#) websites.

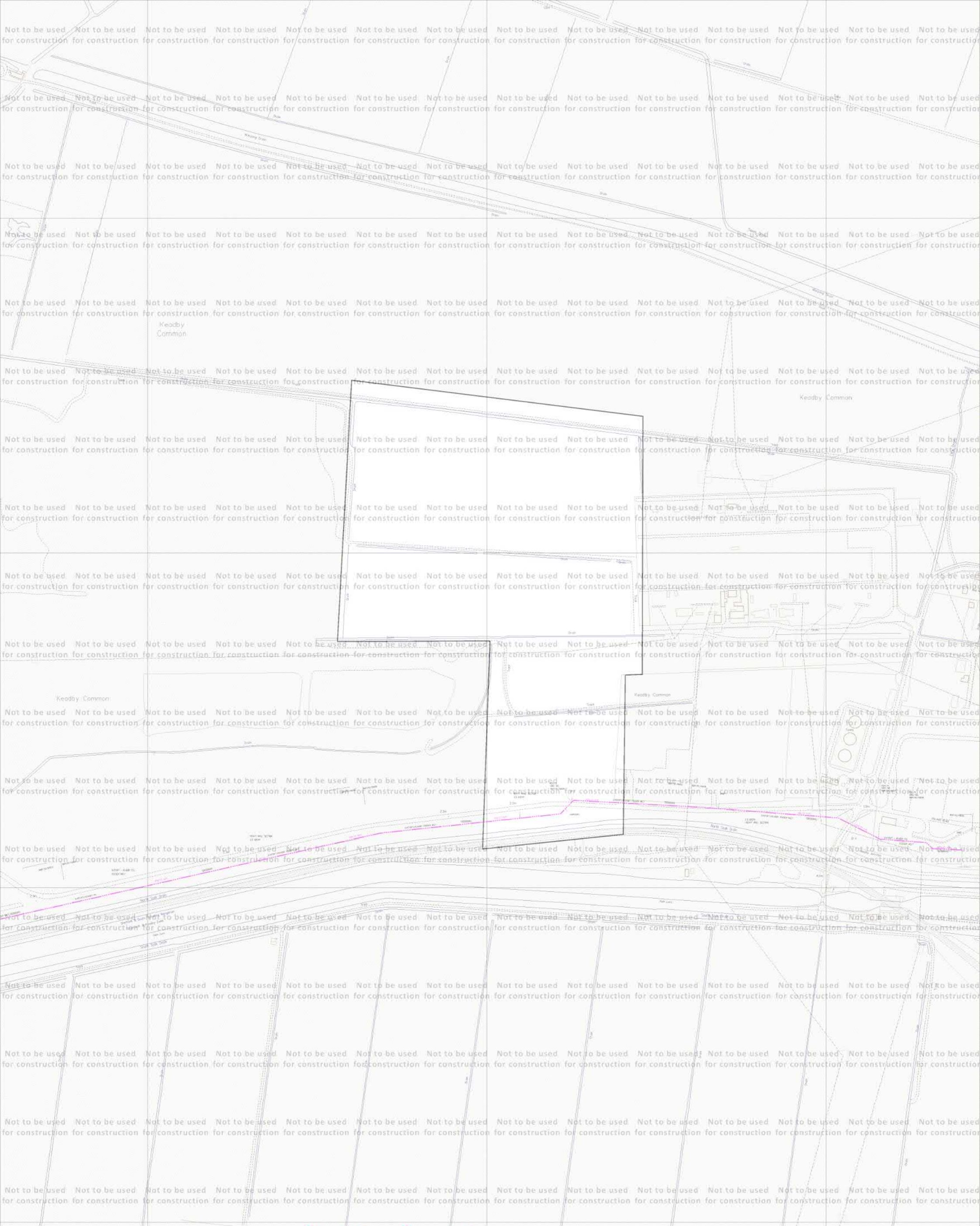

ID: EM_GE1A_3SWX_733897
 USER: joe.goodchild
 DATE: 09/10/2020
 DATA DATE: 08/10/2020
 REF: 607277 - Keady Power Station V
 MAP REF: SE8211
 CENTRE: 482005, 411908

View extent: 1445m, 1835m

LP MAINS ————
 MP MAINS ————
 IP MAINS ————
 LHP MAINS ————
 NHP MAINS ————

0m ———— 100m
 Approximate scale 1:5000
 on A3 Colour Portrait

Map not to be used for construction

This plan shows those pipes owned by Cadent Gas Limited in its role as a Licensed Gas Transporter (GT). Gas pipes owned by other GTs, or otherwise privately owned, may be present in this area. Information with regard to such pipes should be obtained from the relevant owners. The information shown on this plan is given without warranty, the accuracy thereof cannot be guaranteed. Service pipes, valves, syphons, stub connections, etc., are not shown but their presence should be anticipated. No liability of any kind whatsoever is accepted by Cadent Gas Limited or their agents, servants or contractors for any error or omission. Safe digging practices, in accordance with HS(G)47, must be used to verify and establish the actual position of mains, pipes, services and other apparatus on site before any mechanical plant is used. It is your responsibility to ensure that this information is provided to all persons (either direct labour or contractors) working for you on or near gas apparatus. The information included on this plan should not be referred to beyond a period of 28 days from the date of issue.

Map 1 of 2 (GAS)

MAPS Plot Server Version 1.11.0

Cadent
 Your Gas Network

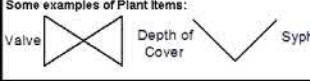

Requested by: Premier Energy Services

This plan is reproduced from or based on the OS map by Cadent Gas Limited, with the sanction of the controller of HM Stationery Office. Crown Copyright Reserved. Ordnance Survey Licence number 100024886





ID: EM_GE1A_3SWX_733897
 USER: joe.goodchild
 DATE: 09/10/2020
 DATA DATE: 14/08/2020
 REF: 607277 - Keady Power Station V
 MAP REF: SE8211
 CENTRE: 482005, 411908

View extent: 1445m, 1835m
 Underground cables 
 Overhead lines 
 0m  100m
 Approximate scale 1:5000
 on A3 Colour Portrait

Map not to be used for construction

This plan shows those cables owned by National Grid Electricity Transmission plc in its role as a Licensed Electricity Transporter (ET). Electricity cables owned by other ETs, or otherwise privately owned, may be present in this area. Information with regard to such cables should be obtained from the relevant owners. The information shown on this plan is given without warranty, the accuracy thereof cannot be guaranteed. Ancillary equipment such as cooling systems and communication cables are not shown but their presence should be anticipated. No liability of any kind whatsoever is accepted by National Grid Electricity Transmission plc or their agents, servants or contractors for any error or omission. Safe digging practices, in accordance with HS(G)47, must be used to verify and establish the actual position of cables and other apparatus on site before any mechanical plant is used. It is your responsibility to ensure that this information is provided to all persons (either direct labour or contractors) working for you on or near electricity apparatus. The information included on this plan should not be referred to beyond a period of 28 days from the date of issue.

Map 2 of 2 (ELECTRIC)
 MAPS Plot Server Version 1.11.0

 Requested by: Premier Energy Services
 This plan is reproduced from or based on the OS map by National Grid Electricity Transmission plc, with the sanction of the controller of HM Stationery Office. Crown Copyright Reserved. Ordnance Survey Licence number 100024241

ENQUIRY SUMMARY

Received Date

09/10/2020

Your Reference

607277 - Keady Power Station West

Location

Centre Point: 482005, 411908

X Extent: 452

Y Extent: 702

Location Description: Bonnyhale Road, Keadby, North Lincolnshire, DN17 3ER

Map Options

Paper Size: A3

Orientation: PORTRAIT

Requested Scale: 2500

Actual Scale: 1:5000 (GAS), 1:5000 (ELECTRIC)

Real World Extents: 1445m x 1835m (GAS), 1445m x 1835m (ELECTRIC)

Recipients

joe.goodchild@premierenergy.co.uk

Enquirer Details

Organisation Name: Premier Energy Services

Contact Name: Joe Goodchild

Email Address: joe.goodchild@premierenergy.co.uk

Telephone: 01403289849

Address: Premier House, Daux Road, Billingshurst, Billingshurst, West Sussex, RH14 9SJ

Description of Works

plans only

Enquiry Type

Proposed Works

Activity Type

Development Project

Work Types

Work Type: Plans Only

Joe Goodchild

From: Harshita K S <Harshitha.KS@atkinsglobal.com>
Sent: 12 October 2020 10:54
To: Joe Goodchild
Subject: RE: Plant Enquiry - Keady Power Station West

Please note that according to our records there is leased and/or third party network within your proposed works. However, because the plant is leased/third party we do not hold 'As Built' records. We strongly recommend you contact all other utility providers to gather the extent of services within that area. Unfortunately, we are unable to advise who the plant is leased to or who the third party is.

IMPORTANT - PLEASE READ = Your Next Step?:-

Where apparatus is affected and requires diversion, please send all the scheme related proposals that affects the Vodafone Network to c3requests@vodafone.com with a request for a 'C3 Budget Estimate'. Please ensure you include a plan showing proposed works. (A location plan is insufficient for Vodafone to provide a costing). These estimates will be provided by Vodafone directly, normally within 20 working days from receipt of your request. Please include proof of this C2 response when requesting a C3 (using the 'forward' option). Diversionary works may be necessary if the existing line of the highway/railway or its levels are altered.

If you require a quote for new development, commercial site connections - please email your requirements and associated plans to c3requests@vodafone.com and a budget estimate will be returned, within 10 working days of receipt.

Plant Enquiries Team
T: +44 (0)1454 662881
E: osm.enquiries@atkinsglobal.com

This response is made only in respect to electronic communications apparatus forming part of the Vodafone Limited electronic communications network formerly being part of the electronic communications networks of Cable & Wireless UK (now re-named Vodafone Enterprise UK), Energis Communications Limited, Thus Group Holdings Limited and Your Communications Limited.

ATKINS working on behalf of Vodafone: Fixed



PLEASE NOTE:

The information given is indicative only. No warranty is made as to its accuracy. This information must not be solely relied upon in the event of excavation or other works carried out in the vicinity of Vodafone plant. No liability of any kind whatsoever is accepted by Vodafone, its servants, or agents, for any error or omission in respect of information contained on this information. The actual position of underground services must be verified and established on site before any mechanical plant is used. Authorities and contractors will be held liable for the full cost of repairs to Vodafone's apparatus and all claims made against them by Third parties as a result of any interference or damage.



Please consider the environment before printing this e-mail

From: Joe Goodchild <joe.goodchild@premierenergy.co.uk>
Sent: 09 October 2020 18:21

Joe Goodchild

From: Plantenquiries <plantenquiries@catelecomuk.com>
Sent: 20 October 2020 17:39
To: Joe Goodchild
Subject: RE: Plant Enquiry - Keady Power Station West

Please Note: Our search criteria has changed. We previously searched for Colt Network which was within 200 metres, this has now changed to 50 metres. The negative response will be for all enquiries that the network is 50 metres or more away from the place of enquiry.

Dear Sir/Madam,

Thank you for your enquiry for the above reference.

We can confirm that Colt Technology Services do not have apparatus near the above location as presented on your submitted plan, if any development or scheme amendments fall outside the 50 metre perimeter new plans must be submitted for review.

Search is based on Overseeing Organisation Agent data supplied; we do not accept responsibility for O.O. Agent inaccurate data.

If we can be of any further assistance please do not hesitate to contact us.

Kind regards,

Plant Enquiry Team



Please consider the environment before printing this email.

This e-mail and any files transmitted with it are confidential and are intended solely for the use of the intended recipient(s). If you are not the intended recipient, you must not copy, distribute or take any action based on this communication. If you have received this communication in error please contact plantenquiries@catelecomuk.com and delete this communication and any copies of it. Any views or opinions presented are solely those of the author and do not necessarily represent those of C A Telecom LTD. C A Telecom LTD monitors e-mails to ensure that its systems operate effectively and to minimise the risk of viruses.

From: Joe Goodchild <joe.goodchild@premierenergy.co.uk>
Sent: 09 October 2020 13:04
To: Plantenquiries <plantenquiries@catelecomuk.com>
Subject: Plant Enquiry - Keady Power Station West

Joe Goodchild

From: KPN Plant Enquiries <kpn.plantenquiries@instalcom.co.uk>
Sent: 16 October 2020 14:19
To: Joe Goodchild
Subject: RE:K10-20- 2557 Plant Enquiry - Keady Power Station West



Dear Sir or Madam,

With reference to your plant enquiry below, we can confirm that KPN do not have any apparatus within the immediate proximity of your proposed works.

If you require any further information, please do not hesitate to contact us.

Please note that this response is only valid for 3 months. If your works do not commence within this time period, please resubmit your plant enquiry for assessment before any works commence.

Regards

Plant Enquiries Dept
Instalcom Limited
Borehamwood Ind. Park
Rowley Lane
Borehamwood
WD6 5PZ

Office: +44 (0)208 731 4613
Fax: +44 (0)208 731 4601
Email: kpn.plantenquiries@instalcom.co.uk
Web: <http://www.instalcom.co.uk>



From: Joe Goodchild <joe.goodchild@premierenergy.co.uk>
Sent: 09 October 2020 13:05
To: KPN Plant Enquiries <kpn.plantenquiries@instalcom.co.uk>
Subject: Plant Enquiry - Keady Power Station West

Dear Plant Enquiries,

Joe Goodchild

From: NRSWA <nrswa.nrswa@sky.uk>
Sent: 09 October 2020 16:47
To: Joe Goodchild
Subject: Plant Enquiry - Keady Power Station West



Thank you for your enquiry.

Please be advised that Sky Telecommunications Services Ltd will not be affected by your proposal.

Best endeavours have been made to ensure accuracy, however if you require further information, please contact us by email at nrswa@sky.uk.

Regards

NRSWA Department
Tech UK - Implementation

sky | TECHNOLOGY

✉ nrswa@sky.uk ☎ +44 20703232234

From: Joe Goodchild <joe.goodchild@premierenergy.co.uk>
Sent: 09 October 2020 13:06
To: NRSWA <nrswa.nrswa@sky.uk>
Subject: [EXTERNAL] Plant Enquiry - Keady Power Station West

Dear Plant Enquiries,

Please search the following location for your plant:

Bonnyhale Road, Keadby, North Lincolnshire, DN17 3ER

[482033,411946]

A location plan (2 pages) showing the search area is attached. If you have plant within the search area or close to the boundary please provide record drawings, ideally by email attachment. Please provide your information as soon as possible.

Many thanks.

Kind regards,

Joe Goodchild

From: Plantenquiries <Plantenquiries@instalcom.co.uk>
Sent: 15 October 2020 11:51
To: Joe Goodchild
Subject: E10-20-3829 RE: Plant Enquiry - Keady Power Station West

Dear Sir or Madam,

Thank you for your plant enquiry below.

We can confirm that CenturyLink Communications UK Limited (formerly Level 3), Global Crossing (UK) Ltd, Global Crossing PEC, Fibernet UK Ltd and Fibrespan Ltd do not have any apparatus within the indicated works area.

Instalcom responds to plant enquiries for all of the above and therefore you only need send one plant enquiry to cover all of these companies.

Please note that this response is only valid for 3 months. If your works do not commence within this time period, please resubmit your plant enquiry for assessment before any works commence.

Regards

Plant Enquiries Dept
Instalcom Limited
Borehamwood Ind. Park
Rowley Lane
Borehamwood
WD6 5PZ

Office: +44 (0)208 731 4613
Fax: +44 (0)208 731 4601
Email: plantenquiries@instalcom.co.uk
Web: <http://www.instalcom.co.uk>



From: Joe Goodchild [mailto:joe.goodchild@premierenergy.co.uk]
Sent: 09 October 2020 13:07
To: Plantenquiries <Plantenquiries@instalcom.co.uk>
Subject: Plant Enquiry - Keady Power Station West

Dear Plant Enquiries,

Joe Goodchild

From: UK OSP-Team <osp-team@uk.verizon.com>
Sent: 12 October 2020 17:14
To: Joe Goodchild
Cc: UK OSP-Team
Subject: RE: [E] Plant Enquiry - Keady Power Station West

Dear Sir/Madam

Verizon is a licensed Statutory Undertaker.

We have reviewed your plans and have determined that Verizon (Formally known as MCI WorldCom, MFS) has no apparatus in the areas concerned.

If you have any further queries please do not hesitate to get in touch.

Yours faithfully

Plant Protection Officer E.mail osp-team@uk.verizon.com

From: Joe Goodchild [mailto:joe.goodchild@premierenergy.co.uk]
Sent: 9 October, 2020 1:08 PM
To: UK OSP-Team
Subject: [E] Plant Enquiry - Keady Power Station West

Dear Plant Enquiries,

Please search the following location for your plant:

Bonnyhale Road, Keadby, North Lincolnshire, DN17 3ER

[482033,411946]

A location plan (2 pages) showing the search area is attached. If you have plant within the search area or close to the boundary please provide record drawings, ideally by email attachment. Please provide your information as soon as possible.

Many thanks.

Kind regards,

Joe Goodchild

Utility Searches

01403 740240 | joe.goodchild@premierenergy.co.uk

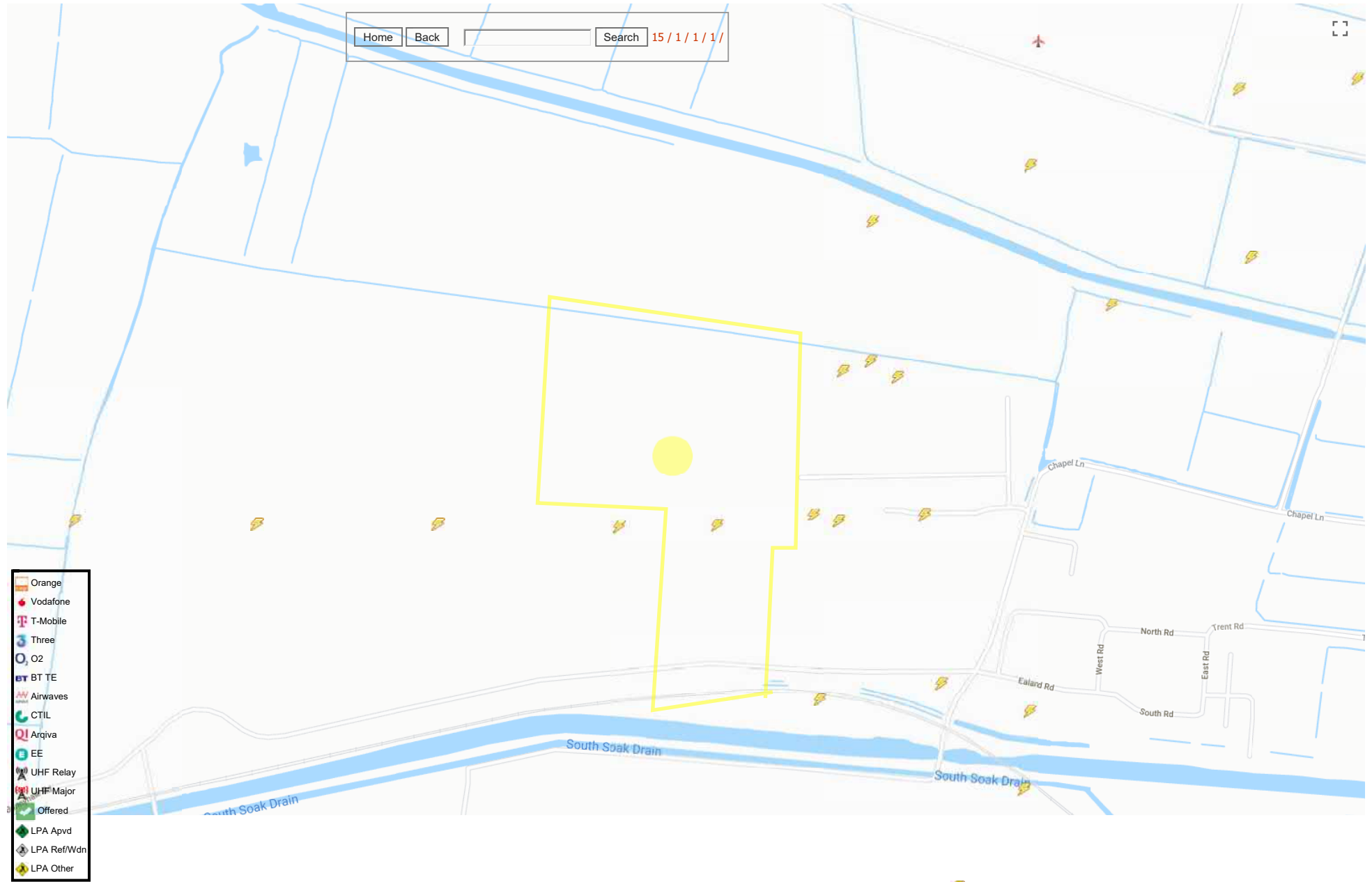



Worksite Survey Team
National Records Centre
Audax Road
YORK

NRSWA Asset Enquiries

YO30 4US

Dear Sir/Madam,

Please find information available as per the checklist.

The information contained herein is based on Network Rail's records and, where appropriate, third parties such as utility companies. The search enclosed does not cover a search of local council records. Also, schematic Signal and Telecom (S&T) cables plans are not provided as part of the search results, therefore you must assume S&T cables are present until proven otherwise.

Although at the date of this letter the information is as up to date as possible, it is **NOT** a statement of validity, accuracy or completeness as to any of the enclosed search information and must not be relied on as such.

Your risk assessment **MUST** take into account:

- That the information supplied, including the services shown on the map from the Rail Infrastructure Network Model (RINM), does not provide any guarantee as to the accuracy of the actual location of services on site and **MUST** be considered as for guidance purposes only.
- That new/unrecorded services are likely to be present
- That the enclosed buried services search information has been collated only for the ELR and Mileage boundaries as stated on the original request form

Included in the buried services search is a list of ASPRO engineers & managers you **MUST** contact before any ground disturbance is carried out, to check whether further information is held locally.

Further guidance can be obtained from the Health and Safety Executive publication HSG47 "Avoiding Danger from Underground Services" and the Network Rail Publication NR/L2/INI/CP1030.

Should you become aware of any additional underground services or assets within the locality during your investigations and/or works, including redundant assets, please identify them as a matter of urgency to the site manager. Records of the location of these assets should be kept for onward transmission and entry into the Hazard Directory.

Yours sincerely

NRSWA Team

Worksite Survey

Buried Services Information Checklist			
Your Ref	Keady Power Station West	Our Order Ref	71956
Network Rail Record Type		Category	Enc. Yes/No
Asset Protection National Map	Contact Info	Y	
Hazard Directory	Hazard	Y	
Site Map	GIS Systems	Y	
eB - Corporate records management system	National Records Group	N	Nil return
National Records Group - Civils Records	National Records Group	Y	

NIL RETURN: After interrogating the information made available to us, no records containing buried services information have been returned for this worksite.

However, reference must be made to the guidelines supplied with this buried services search, which contain important information on safe working practices.



Please complete a development questionnaire and submit it to the relevant route email address found on the map below

The Asset Protection Project Managers lead dedicated teams in providing advice to the public who are planning activities on or near the railway.

The teams deal with a multitude of issues including neighbouring construction sites, utility works, bridge works, domestic maintenance, new road schemes, inspection and surveying and works within the designated precautionary area of level crossings.

* It does not cover subjects such as emergencies, Town & Country Planning, property sales or complaints.

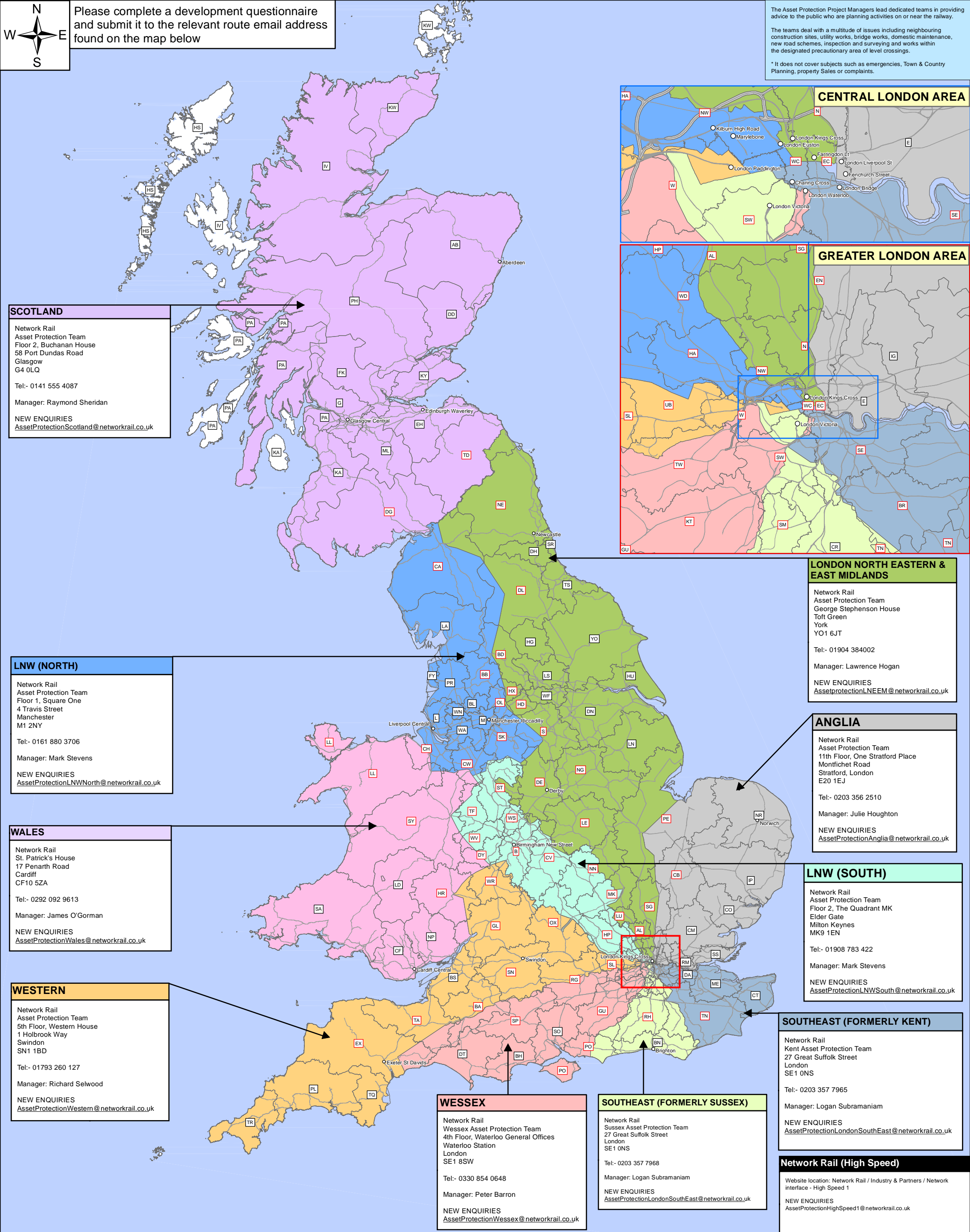

SCOTLAND

Network Rail
Asset Protection Team
Floor 2, Buchanan House
58 Port Dundas Road
Glasgow
G4 0LQ

Tel:- 0141 555 4087

Manager: Raymond Sheridan

NEW ENQUIRIES
AssetProtectionScotland@networkrail.co.uk

CENTRAL LONDON AREA

London Kings Cross
London Liverpool St
London Victoria
London Waterloo
London Paddington
Charing Cross
Fenchurch Street
London Bridge
London Waterloo

GREATER LONDON AREA

London Kings Cross
London Victoria
London Waterloo

LONDON NORTH EASTERN & EAST MIDLANDS

Network Rail
Asset Protection Team
George Stephenson House
Toft Green
York
YO1 6JT

Tel:- 01904 384002

Manager: Lawrence Hogan

NEW ENQUIRIES
AssetProtectionLNEM@networkrail.co.uk

LNW (NORTH)

Network Rail
Asset Protection Team
Floor 1, Square One
4 Travis Street
Manchester
M1 2NY

Tel:- 0161 880 3706

Manager: Mark Stevens

NEW ENQUIRIES
AssetProtectionLNWNorth@networkrail.co.uk

ANGLIA

Network Rail
Asset Protection Team
11th Floor, One Stratford Place
Montfichet Road
Stratford, London
E20 1EJ

Tel:- 0203 356 2510

Manager: Julie Houghton

NEW ENQUIRIES
AssetProtectionAnglia@networkrail.co.uk

WALES

Network Rail
St. Patrick's House
17 Penarth Road
Cardiff
CF10 5ZA

Tel:- 0292 092 9613

Manager: James O'Gorman

NEW ENQUIRIES
AssetProtectionWales@networkrail.co.uk

LNW (SOUTH)

Network Rail
Asset Protection Team
Floor 2, The Quadrant MK
Elder Gate
Milton Keynes
MK9 1EN

Tel:- 01908 783 422

Manager: Mark Stevens

NEW ENQUIRIES
AssetProtectionLNWSouth@networkrail.co.uk

WESTERN

Network Rail
Asset Protection Team
5th Floor, Western House
1 Holbrook Way
Swindon
SN1 1BD

Tel:- 01793 260 127

Manager: Richard Selwood

NEW ENQUIRIES
AssetProtectionWestern@networkrail.co.uk

SOUTHEAST (FORMERLY KENT)

Network Rail
Kent Asset Protection Team
27 Great Suffolk Street
London
SE1 0NS

Tel:- 0203 357 7965

Manager: Logan Subramaniam

NEW ENQUIRIES
AssetProtectionLondonSouthEast@networkrail.co.uk

WESSEX

Network Rail
Wessex Asset Protection Team
4th Floor, Waterloo General Offices
Waterloo Station
London
SE1 8SW

Tel:- 0330 854 0648

Manager: Peter Barron

NEW ENQUIRIES
AssetProtectionWessex@networkrail.co.uk

SOUTHEAST (FORMERLY SUSSEX)

Network Rail
Sussex Asset Protection Team
27 Great Suffolk Street
London
SE1 0NS

Tel:- 0203 357 7968

Manager: Logan Subramaniam

NEW ENQUIRIES
AssetProtectionLondonSouthEast@networkrail.co.uk

LEGEND

CH UK Postcode (within single NR Territory)

CH UK Postcode (split between NR Territories)

— Rail Network

Corporate GIS data is subject to frequent updates therefore any data exported from the corporate GIS system is a static representation of the data at the time of export, and should be treated as such. No warranty or guarantee is given as to the absolute accuracy or completeness of this information. Network Rail disclaims any responsibility for any loss, damage or inconvenience howsoever caused arising out of or as a consequence of reliance on this information in any context.

ASPRO NATIONAL MAP			
CLIENT: SAFETY, TECHNICAL & ENGINEERING			
JOB NO.:	10519.104	USE TYPE:	[INTERNAL]
SCALE :	1:3,000,000 @ A3	DATE:	10/01/2019
VERSION:	03	PRODUCED BY:	AS
		QA BY:	SD

NetworkRail

Asset Information Services

Contains Ordnance Survey data ©
Crown copyright and database right 2019.
Licence No: 0100040692

GeospatialReportingAnalysis@NetworkRail.co.uk



National Hazard Directory

Terms and Conditions

The National Hazard Directory (NHD) is issued by Network Rail to provide information on those hazards recorded as present on Network Rail's infrastructure. Its purpose is to alert users to the typical hazards they may come across whilst working on Network Rail's Infrastructure. The National Hazard Directory is maintained by Network Rail to provide its employees and contractors with information on known hazards present on the infrastructure in order to assist in the identification of the associated risks working 'on or near the line'.

The records are updated regularly and therefore Network Rail believe that the contents are reasonably accurate at the time of issue, but some of the information can vary in age and accuracy so for that reason Network Rail will give no warranty as to the suitability of its use. It is recommended that all searches (in particular for buried services) should be conducted together with a site specific risk assessment/site visit, taking into account the requirements of the appropriate track safety rules, rule books/industry standards and so on. Network Rail will accept no liability in respect of the content or subsequent use of the National Hazard Directory or any of the information contained within.

Users of the Directory must note that when working on or near the line that the appropriate requirements of the Rule Book, especially the provisions of the track safety rules, must be applied as appropriate to the activity concerned.

OnTrac Ltd does not warrant the use of the Network Rail National Hazard Directory or any of the information contained within and no representations or warranties are made as to completeness or accuracy of the data. The data should be used for reference purposes only. Accordingly, OnTrac Ltd will accept no responsibility for loss of profit or for any indirect, incidental or consequential damages.

National Hazard Directory**Customised Report**

Search Criteria: ELR(s) = DOW; Mileage From = 17.1406; Mileage To = 18.0027

Date: 20/10/2020

3 Hazards found.

ELR	ELR Name	Mileage From	Mileage To	Hazard Description	Local Name	Track ID	Free Text
DOW		13.0044	17.1540	COSS or IWA may not work alone	MEDGE HALL TO KEADBY	All/Multiple Tracks	THIS WALK TO BE DONE BY RED ZONE WITH LOOKOUTS DUE TO THE CURVATURE OF THE TRACK.
DOW		17.0044	17.1650	Landfill Gases	KEADBY POWER STATION KEADBY	Unknown	LANDFILL GAS. This stretch of railway has been identified as being at risk from the migration of landfill gasses. Appropriate precautions should be taken. For further information please contact nationalminingengineer@networkrail.co.uk
DOW	DONCASTER WRAWBY	17.0950	19.1100	COSS or IWA may not work alone	Keadby to Althorpe	All/Multiple Tracks	Restricted Sighting due to Curvature of Track, ALL LINES, and Structures.

User Drawn Polygon / Area of Interest - Order ID : 71956



Legend

- Company Ownership**
- Freehold Ownership
- Leasehold Ownership
- Prohibitive Interest
- Bridge (Rail over Rail)
- Bridge (Rail over River)
- Bridge (Rail over Road)
- Bridge (Road over Rail)
- Level Crossing
- Tunnel
- Order Polygon

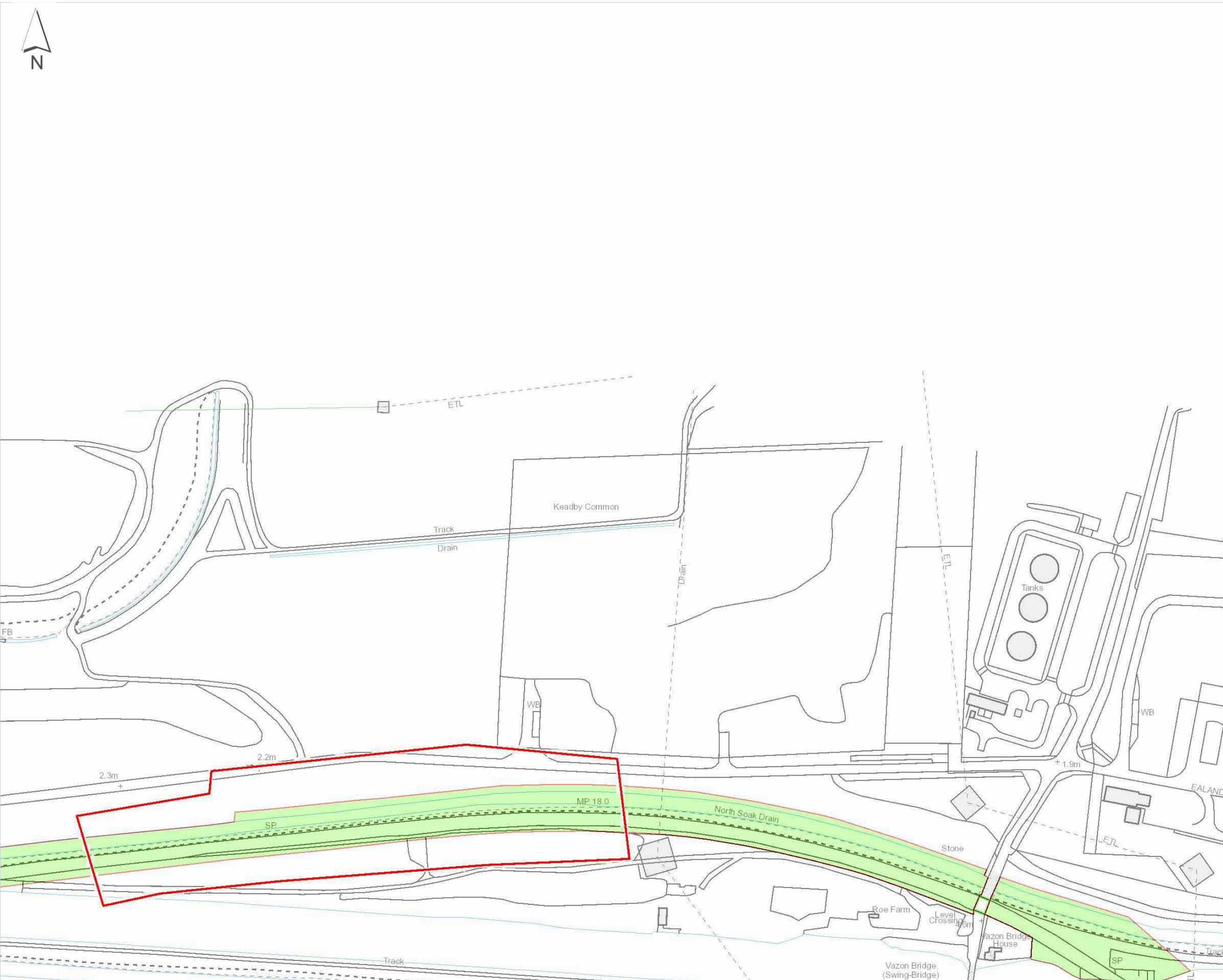

Nearest station:
Aldhorpe Stn

Order ID: 71956

Order Ref: 71956
Plot Scale: 1:2500
Page Index: 1
Centre X, Y: 482262, 411797
Plot Date: 09/10/20



Crown copyright and database rights 2020
Ordnance Survey 0100040692

Buddi Spandana

From: Murray Sandra on behalf of NRG Enquiries
Sent: 21 October 2020 13:28
To: Fuller Dain
Subject: Buried Services Search: 71956
Attachments: 71956 Results.xlsx; 71956.zip

OFFICIAL

Good Afternoon,

Thank you for your recent enquiry for buried services records from the NRG.

With reference to:
Project Number - N/a
Project Name/Location - Keady Power Station West

	No Network Rail records have been found
2	Record(s) sent via email *
	Record(s) sent via CD/DVD *
	Record(s) sent via following hyperlink *

*** This hyperlink has been sent to you as the 'Customer'. This link cannot be shared with anyone else, you will need to contact us at NRGENquiries@networkrail.co.uk to arrange alternate access. Please note it takes up to 10 minutes for your records to be uploaded to the Civils Digital Transfer Site. If you attempt to access immediately, it may result in a failed attempt to extract the records.*

All other aspects including the Utility Companies search results will be sent to you separately by the Worksite Survey Team.

Please direct all queries to WorksiteSurveyTeam@networkrail.co.uk.

* Please note that a copy of your request will only be kept by the NRG for **4 weeks**. You must notify the NRG within this timeframe if you do not download the records or there are any issues. After this time, your request must be re-submitted quoting the unique ID reference number which is indicated in the subject header of this e-mail. This will then be logged and dealt with in accordance with our Service Level Agreements.

Kind regards,

National Records Group



National Record Centre | Audax Road | Clifton Moor | York YO30 4US
NRGENquiries@networkrail.co.uk
www.networkrail.co.uk

SE 8212
ADJOINING
SHEET
NUMBERS
SE 8111
SE 8210
SE 8311

SE 8211 HV see LV



Based upon the Ordnance Survey Map with the sanction of the
controller of Her Majesty's Stationery Office. Crown copyright reserved. ©
Licensee: YORKSHIRE ELECTRICITY GROUP plc
Registered Office Wetherby Road, Scarcroft, Leeds, LS14 3HS
Registered in England and Wales No. 2366995

scale
1:2500
mains record sheet
SE 8211

YORKSHIRE ELECTRICITY GROUP plc

The position of our equipment is shown on this plan as accurately as possible. However it may have changed since the plan was produced. Therefore the position of our equipment and those of service cables, which may not be shown, should be established on site.

Other electricity cables, not owned by ourselves may also be laid in the area shown on this plan. Information on these can be obtained from the owners.

ALAN HOWSON — System Data Manager

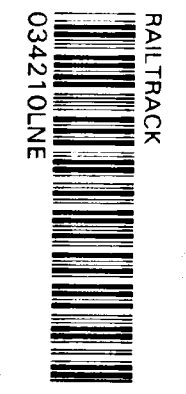

Don - Scun
16 DEC 1993
18

DONCASTER TO GRIMSBY LINE.

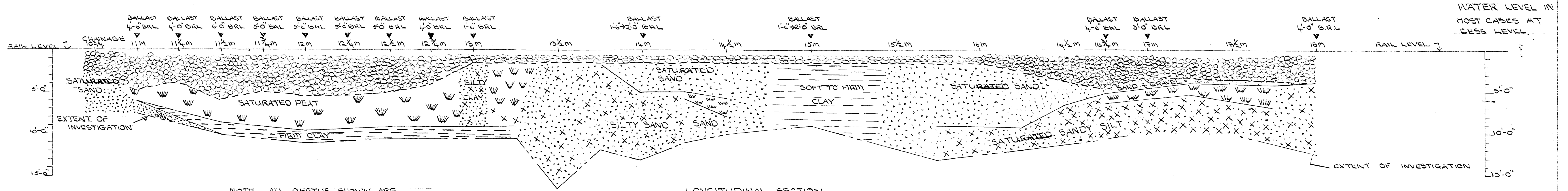

NOTE ALL DEPTHS SHOWN ARE
RELATIVE TO RAIL LEVEL
AT PLACE OF INVESTIGATION

LONGITUDINAL SECTION

WATER LEVEL IN
MOST CASES AT
CESS LEVEL.



BRITISH RAILWAYS BOARD		NORTH EASTERN REGION	
BRITISH RAILWAYS CHIEF CIVIL ENGINEER'S DEPT		SECTION	
REVISED	DONCASTER TO GRIMSBY LINE FORMATION INVESTIGATION TO DETERMINE DEPTH OF PEAT		
DESIGNED	CE APPROVED	SCALES	
Drawn	REP.	DES NO	
Traced	REP.	CES NO	71/110/701
CHIEF CIVIL ENGINEER			

Joe Goodchild

From: Carly Pidd <Carly.Pidd@northlincs.gov.uk> on behalf of Highway Maintenance <Highway.Maintenance@northlincs.gov.uk>
Sent: 13 October 2020 09:56
To: Joe Goodchild
Subject: Fw: Plant Enquiry - Keady Power Station West
Attachments: Plant Enquiry - Keady Power Station West.pdf

Good morning

Street lighting have no assets in this location

Mark
Mark Theakstone
Street Lighting Officer
North Lincolnshire Council,
8-9 Billet Lane,
Normanby Enterprise Park,
Scunthorpe,
North Lincolnshire
DN15 9YH

In uncertain times... Bring certainty to a child's life. Be their family.

#youcanadopt Give us a call or go to our website to find out more

01724 297024

www.northlincs.gov.uk/adoption

Ofsted
Outstanding Provider

North Lincolnshire Council

12 00

From: Joe Goodchild <joe.goodchild@premierenergy.co.uk>
Sent: 09 October 2020 12:58
To: Highway Maintenance
Subject: Plant Enquiry - Keady Power Station West

Dear Highway Maintenance,
Please search the following location for any council owned plant including street lighting, highways drainage or fibre:

Joe Goodchild

From: Carly Pidd <Carly.Pidd@northlincs.gov.uk> on behalf of Highway Maintenance
<Highway.Maintenance@northlincs.gov.uk>
Sent: 13 October 2020 09:55
To: Joe Goodchild
Subject: Fw: Plant Enquiry - Keady Power Station West

Good morning

Further to the above plant enquiry, I can confirm North Lincolnshire Council have no records of any highway structures within the identified area of interest.

Regards

Sarah Henson
Technical Assistant – Strategy & Client Services
Highways & Neighbourhoods
Tel: 01724 296372



In uncertain times... Bring certainty to a child's life. Be their family.

#youcanadopt Give us a call or go to our website to find out more

01724 297024

www.northlincs.gov.uk/adoption

Ofsted Outstanding Provider

North Lincolnshire Council



In uncertain times... Bring certainty to a child's life. Be their family.

#youcanadopt Give us a call or go to our website to find out more

01724 297024

www.northlincs.gov.uk/adoption

Ofsted Outstanding Provider

North Lincolnshire Council

From: Joe Goodchild <joe.goodchild@premierenergy.co.uk>
Sent: 09 October 2020 12:58
To: Highway Maintenance
Subject: Plant Enquiry - Keady Power Station West

Dear Highway Maintenance,
Please search the following location for any council owned plant including street lighting, highways drainage or fibre:
Bonnyhale Road, Keadby, North Lincolnshire, DN17 3ER
[482033,411946]



Groundsure

Apogee Full Utility Search

1, Chesswick Crescent

LOCATION INTELLIGENCE

To access Groundsure's market leading environmental solutions,
please call **08444 159 000** or email **info@groundsure.com**

WWW.GROUNDSURE.COM



1, Chesswick Crescent,

Site Address:

**1, Chesswick Crescent
Keadby
DN17 3DH**

22/03/2021

PROJECT NO.
422015

ISSUE NO.
1

STATUS
Full Utility Search

LOCATION INTELLIGENCE

To access Groundsure's market leading environmental solutions,
please call **08444 159 000** or email **info@groundsure.com**
WWW.GROUNDSURE.COM

C2 Stats Plans Responses Summary

Apogee Job Number: 422015
 Client Site Name: 1, Chesswick Crescent
 Percentage Complete: 100%

Client Job Number: GS-7652017

Utility Name	Utility Type	Affected	Not Affected	No Response Received	Comments
Northern Power	Electric	22/03/2021			
Utility Assets	Electric		05/04/2021		
Cadent	Gas	22/03/2021			
GTC	Multi		22/03/2021		
Last Mile (Energetics)	Multi		22/03/2021		
Engie	Multi		22/03/2021		
Yorkshire Water	Water	22/03/2021			
Severn Trent Water	Sewerage		22/03/2021		
BT	Telecoms	09/04/2021			
Vodafone (C&W, Energis, Thus)	Telecoms		23/03/2021		
Virgin Media	Telecoms		22/03/2021		
Cityfibre	Telecoms		09/04/2021		
Colt (CA Telecom)	Telecoms		25/03/2021		
EUNetworks	Telecoms		29/03/2021		
Lumen Technologies	Telecoms		22/03/2021		
Instalcom KPN	Telecoms		22/03/2021		
Kcom	Telecoms		23/03/2021		
Sky	Telecoms		22/03/2021		
Sota	Telecoms		24/03/2021		
Telent	Telecoms		23/03/2021		
Verizon	Telecoms		22/03/2021		
Linesearch	Linesearch	22/03/2021			
Mast Data	Telecoms		09/04/2021		
Coal Authority	Mining		09/04/2021		

See end of report for acronyms key, basic risk assumptions and further information on how to interpret and use the information in this report



Job No:	422015
Approved by:	Jeremy Haigh
Date of First Issue:	09/04/2021
Signature:	

Date	Version	Created by	Description of change
09/04/2021	0.1	Keith Smith	First & Final Issue



Date: 22/03/2021

Mr SMITH
Blount House Hall Park Court
Hall Park Way
Telford
TF3 4NQ

Tel: 0191 229 4294
Northern Powergrid Records Information Centre
New York Road
Shiremoor
Newcastle Upon Tyne
NE27 0LP

Dear Mr SMITH

Enquiry No: SD470635
Scheme Reference: 1 Chesswick Crescent

Thank you for using Northern Powergrid's online Safedig service for your planned works.

Your plan has been generated using our most up to date information. Due to the nature of the information we hold and how often works on the network are carried out, we can only guarantee this plan at the time of generation. We will do our best to notify you if we update the information in your indicated area, but you should endeavour to obtain an up to date plan whenever you commence your works.

The map that has been provided to you will show all the relevant Northern Powergrid electricity cables that are in your indicated dig site, we have included some of the surrounding area as well in case your dig extends further than you previously thought. At any point you may re-apply for your plan to increase the indicated area using the previously submitted details. This plan will be valid for 30 days from the point at which it became available to you.

The enclosed mains records only give the approximate location of known Northern Powergrid apparatus in the area. Great care is therefore needed and all cables and overhead lines must be assumed to be live.

Please note that while all efforts are made to ensure the accuracy of the data, no guarantee can be given. We would refer you to the Health & Safety Executive's publication HS(G)47 "Avoiding Danger From Underground Services" which emphasises that:

- Plans must only be used as a guide in the location of underground cables. The use of a suitable cable-tracing device is essential and careful hand digging of trial holes must be carried out to positively identify and mark the exact route of the cable. You should also bear in mind that a cable is unmistakably located only when it has been safely exposed.
- Cable depths are not generally indicated on our records and can vary considerably even when shown.
- Great caution must be exercised at all times when using mechanical plant. Careful trial digging should always be carried out on the whole route of the planned excavation to ascertain if cables exist.

The Health & Safety executive have another publication, GS6 "Avoidance of Danger from Overhead Electric Lines" that you should be aware of if your work is near overhead powerlines. Both of these documents provide comprehensive guidance for observance of statutory duties under the Electricity at Work Regulations 1989 and the Health & Safety at Work Act 1974. Our provision of these records is based upon the assumption that people using them will have sufficient competence to interpret the information given. Any damage or injury caused will be the responsibility of the organization concerned who will be charged for any repairs.

Please note ground cover must not be altered either above our cables or below overhead lines, in addition no trees should be planted within 3 metres of existing underground cables or 10 metres of overheadlines. All our apparatus is legally covered by a wayleaves agreement, lease or deed or alternatively protected under

the Electricity Act 1989. Should any alteration/diversion of our Company's apparatus be necessary to allow your work to be carried out, budget costs can be provided by writing to Network Connections, Alix House, Falcon Court, Stockton On Tees, TS18 3TU.

Tel:0800 0113433

Yours faithfully,

Safedig Team
Northern Powergrid

NORTHERNPOWERGRID

is the trading name of Northern Powergrid(Northeast) limited(RegisteredNo:2906593) and Northern Powergrid(Yorkshire) pic(Registered No:4112320) Registered Office: lloydsCourt, 78 Grey Street, Newcastle upon Tyne NE1 6AF.Registered in England and Wales.



Assume all Northern Powergrid assets are live, unless proved otherwise

Please establish the on-site position of Northern Powergrid assets prior to the commencement of site works

For specialist assistance or enquiries, please use one of the following options:

General enquiries- 0800 011 3332

- Option 1 -Electricity emergency or power cut
- Option 2- Electricity bill enquiries
- Option 3- New connection, disconnection, meter enquiry, increased load, service alteration
- Option 4- Request for Safedig Plans
- Option 5- Other general enquiries; including request for site visit, safe working heights

Public safety emergency line -(0800 151 3255)

- Reports of exposed underground cables, grounded overhead conductors etc.

Network connections or diversions - 0800 011 3433

- Maximum load enquiries, connection quotation

Wayleave enquiries- Northeast (0191 229 4604) or Yorkshire (01977 605 104)

- Queries relating to ownership of assets, wayleave agreements

If site works are to be performed more than 3 months after you have received safe dig plans from Northern Powergrid, it is advisable that you request a more up to date copy.

Call Centre Phone Numbers: If the area is located in: North East call 0800 668877, Yorkshire or North Lincs call 0800 375675.

Northern Powergrid Holdings Company

The position of our equipment is shown on the plan as accurately as possible, it may have changed since the plan was produced. Therefore the position of our equipment and those services which may not be shown should be established on site. Electricity cables not owned by Northern Powergrid Holdings Company may be laid in this area and may not be shown on this plan. Where private cables are shown, the information should not be regarded as accurate and should be used for guidance purposes only. In all cases, accurate information should be obtained from the owner of such cables prior to the commencement of work on site.

Reference should be made to HSE Guidance, HS(G)47 'Avoiding Danger from Underground Services' and GS6 'Avoidance of Danger from Overhead Power Lines'.

Reproduced from or based upon the Ordnance Survey map by Northern Powergrid Holdings Company by permission of Ordnance Survey on behalf of the Controller of Her Majesty's Stationary Office. Crown (c) Copyright (Northern Powergrid Holdings Company. EL100017931 and EL100036857).

Legend:

Underground Cables:

132kV	20kV	LV Mains
66kV	11kV	LV Service
33kV	6kV	LV Service Assumed Route
25kV	3kV	LV Service Logical Connection
Left In Situ	Aux	

Overhead Conductors:

132kV	20kV	LV Mains
66kV	11kV	LV Service
33kV	6kV	Aux
25kV	3kV	

Date Printed:

Scale: 1:



Job Reference : SD470635

1 Chesswick Crescent

Scale : 1:2600

Grid Coordinates : 480416 410014

Date : 22/03/2021

Produced For :
Mr Keith Smith

Overview Page

Terms and Conditions

Electric cables and/or overhead line information shown on the record plans are to be used in accordance with the Health & Safety Executive's Booklet HS(G)47, "Avoiding Danger from Underground Services" and Guidance Note GS 6, "Avoidance of Danger from Overhead Electric Lines". Record plans do not always show out of commission cables or service cables from Northern Powergrid's mains to adjoining or cross road properties. Plans do not show local authority owned public lighting or sign cables. The information is provided as a service by NorthernPowergrid and does not impart any legal obligation on their part. Persons using it are reminded of their responsibility to execute works safely to avoid damaging Northern Powergrid's apparatus.

Further advice or assistance is available from the Records Information Centre on 0191 2294296
In an emergency or outside normal working hours contact our customer information centre on 0800 668877
Cable depths shown were correct at the time cables were laid however alterations to ground levels or cable disposition may have taken place.

Legend:

Underground Cables:	
Overhead Conductors:	

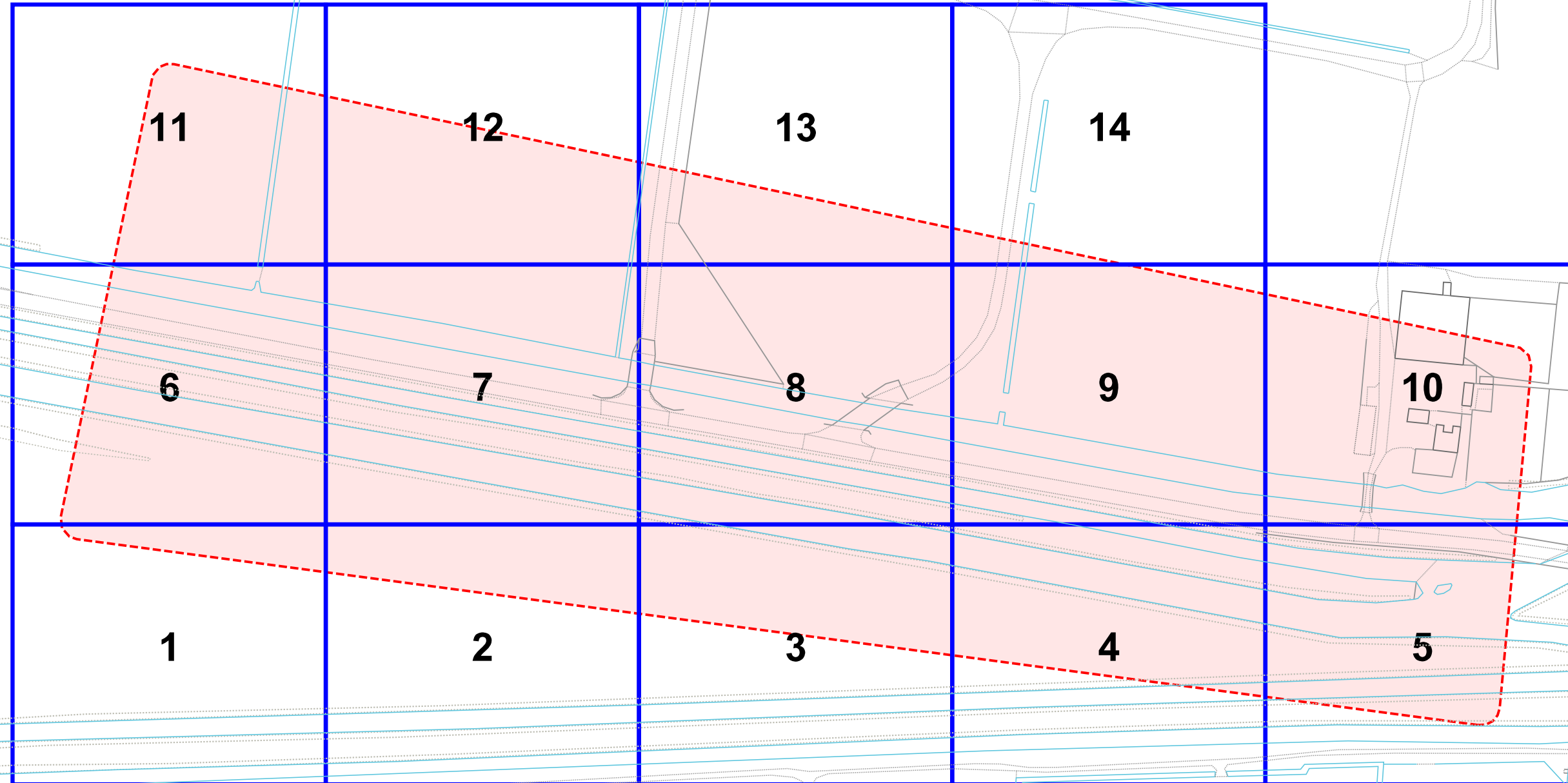
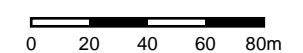



7



Job Reference : SD470635

1 Chesswick Crescent

Scale : 1:500

Grid Coordinates : 480249 409875

Date : 22/03/2021

Produced For :
Mr Keith Smith

Page 2 of 14 (2,14)

Terms and Conditions

Electric cables and/or overhead line information shown on the record plans are to be used in accordance with the Health & Safety Executive's Booklet HS(G)47, "Avoiding Danger from Underground Services" and Guidance Note GS 6, "Avoidance of Danger from Overhead Electric Lines". Record plans do not always show out of commission cables or service cables from Northern Powergrid's mains to adjoining or cross road properties. Plans do not show local authority owned public lighting or sign cables. The information is provided as a service by NorthernPowergrid and does not impart any legal obligation on their part. Persons using it are reminded of their responsibility to execute works safely to avoid damaging Northern Powergrid's apparatus.

Further advice or assistance is available from the Records Information Centre on 0191 2294296
In an emergency or outside normal working hours contact our customer information centre on 0800 668877
Cable depths shown were correct at the time cables were laid however alterations to ground levels or cable disposition may have taken place.

Legend:

- Underground Cables:**
- 132kV
 - 66kV
 - 33kV
 - 25kV
 - Left In Situ
 - LV Mains
 - LV Service Assumed Route
 - LV Service Logical Connection
 - Duct Route
 - 20kV
 - 11kV
 - 6kV
 - 3kV
 - Aux
 - LV Service
- Overhead Conductors:**
- 132kV
 - 66kV
 - 33kV
 - 25kV
 - LV Mains
 - LV Service
 - 20kV
 - 11kV
 - 6kV
 - 3kV
 - Aux

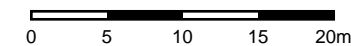

Mr Keith Smith - SD470635
Safedig plans are provided FOC by registering at www.northernpowergrid.com

Mr Keith Smith - SD470635
Safedig plans are provided FOC by registering at www.northernpowergrid.com

Mr Keith Smith - SD470635
Safedig plans are provided FOC by registering at www.northernpowergrid.com

Mr Keith Smith - SD470635
Safedig plans are provided FOC by registering at www.northernpowergrid.com

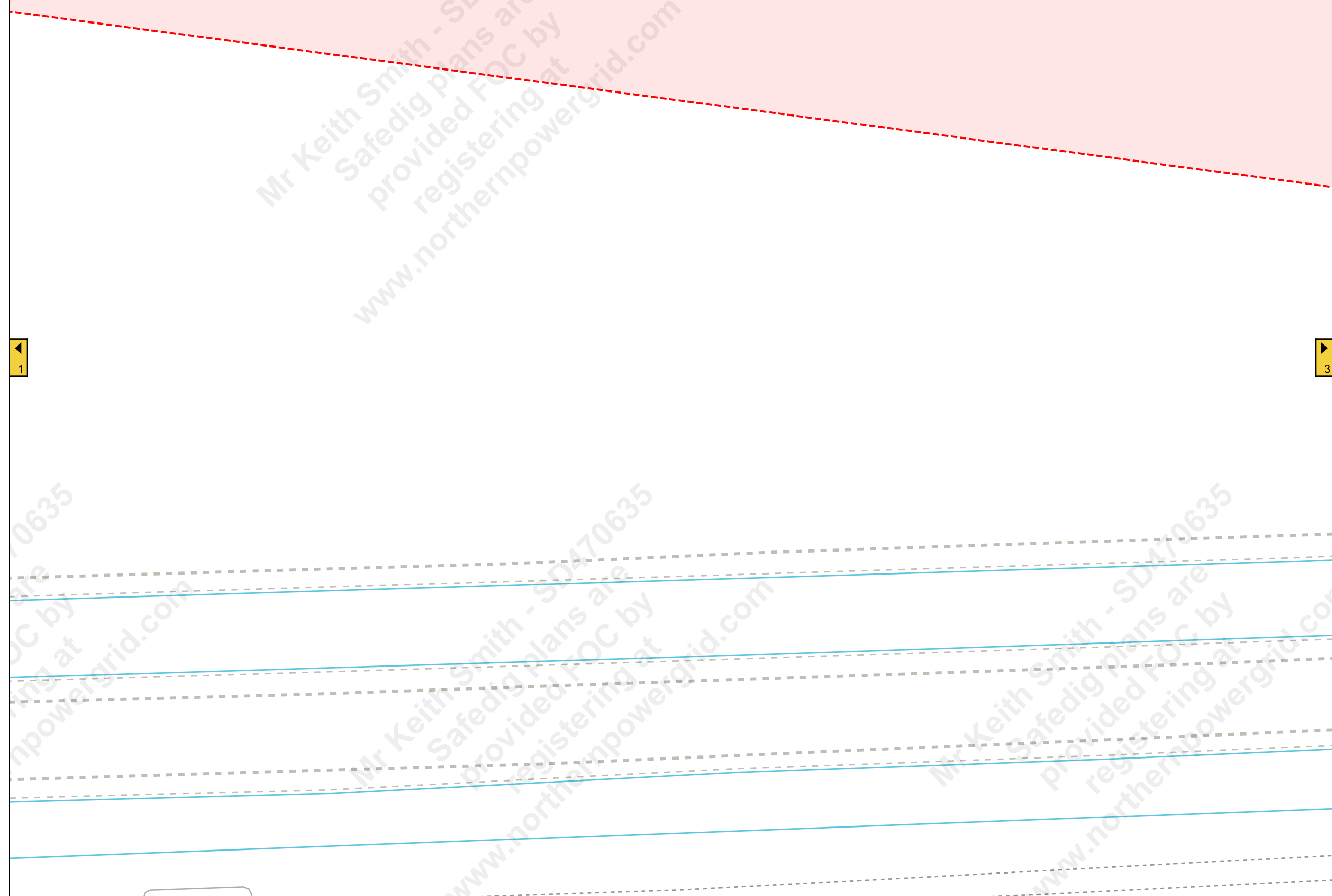



▲ 8



Job Reference : SD470635

1 Chesswick Crescent

Scale : 1:500

Grid Coordinates : 480416 409875

Date : 22/03/2021

Produced For :
Mr Keith Smith

Page 3 of 14 (3,14)

Terms and Conditions

Electric cables and/or overhead line information shown on the record plans are to be used in accordance with the Health & Safety Executive's Booklet HS(G)47, "Avoiding Danger from Underground Services" and Guidance Note GS 6, "Avoidance of Danger from Overhead Electric Lines". Record plans do not always show out of commission cables or service cables from Northern Powergrid's mains to adjoining or cross road properties. Plans do not show local authority owned public lighting or sign cables. The information is provided as a service by NorthernPowergrid and does not impart any legal obligation on their part. Persons using it are reminded of their responsibility to execute works safely to avoid damaging Northern Powergrid's apparatus.

Further advice or assistance is available from the Records Information Centre on 0191 2294296
In an emergency or outside normal working hours contact our customer information centre on 0800 668877
Cable depths shown were correct at the time cables were laid however alterations to ground levels or cable disposition may have taken place.

Legend:

- Underground Cables:**
- 132kV
 - 66kV
 - 33kV
 - 25kV
 - Left In Situ
 - LV Mains
 - LV Service Assumed Route
 - LV Service Logical Connection
 - Duct Route
 - 20kV
 - 11kV
 - 6kV
 - 3kV
 - Aux
 - LV Service
- Overhead Conductors:**
- 132kV
 - 66kV
 - 33kV
 - 25kV
 - LV Mains
 - LV Service
 - 20kV
 - 11kV
 - 6kV
 - 3kV
 - Aux

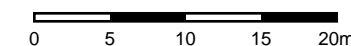

South Engine Drain

Folly Drain

◀ 2

▶ 4

Plans are provided FOC by Northern Powergrid.com
Mr Keith Smith - SD470635
Safedig plans are provided FOC by Northern Powergrid.com
Mr Keith Smith - SD470635
Safedig plans are provided FOC by Northern Powergrid.com

Job Reference : SD470635

1 Chesswick Crescent

Scale : 1:500

Grid Coordinates : 480583 409875

Date : 22/03/2021

Produced For :
Mr Keith Smith

Page 4 of 14 (4,14)

Terms and Conditions

Electric cables and/or overhead line information shown on the record plans are to be used in accordance with the Health & Safety Executive's Booklet HS(G)47, "Avoiding Danger from Underground Services" and Guidance Note GS 6, "Avoidance of Danger from Overhead Electric Lines". Record plans do not always show out of commission cables or service cables from Northern Powergrid's mains to adjoining or cross road properties. Plans do not show local authority owned public lighting or sign cables. The information is provided as a service by NorthernPowergrid and does not impart any legal obligation on their part. Persons using it are reminded of their responsibility to execute works safely to avoid damaging Northern Powergrid's apparatus.

Further advice or assistance is available from the Records Information Centre on 0191 2294296

In an emergency or outside normal working hours contact our customer information centre on 0800 668877

Cable depths shown were correct at the time cables were laid however alterations to ground levels or cable disposition may have taken place.

Legend:

Underground Cables:	
132kV	20kV
66kV	11kV
33kV	6kV
25kV	3kV
Left In Situ	Aux
LV Mains	LV Service
LV Service Assumed Route	
LV Service Logical Connection	
Duct Route	
Overhead Conductors:	
132kV	20kV
66kV	11kV
33kV	6kV
25kV	3kV
LV Mains	Aux
LV Service	

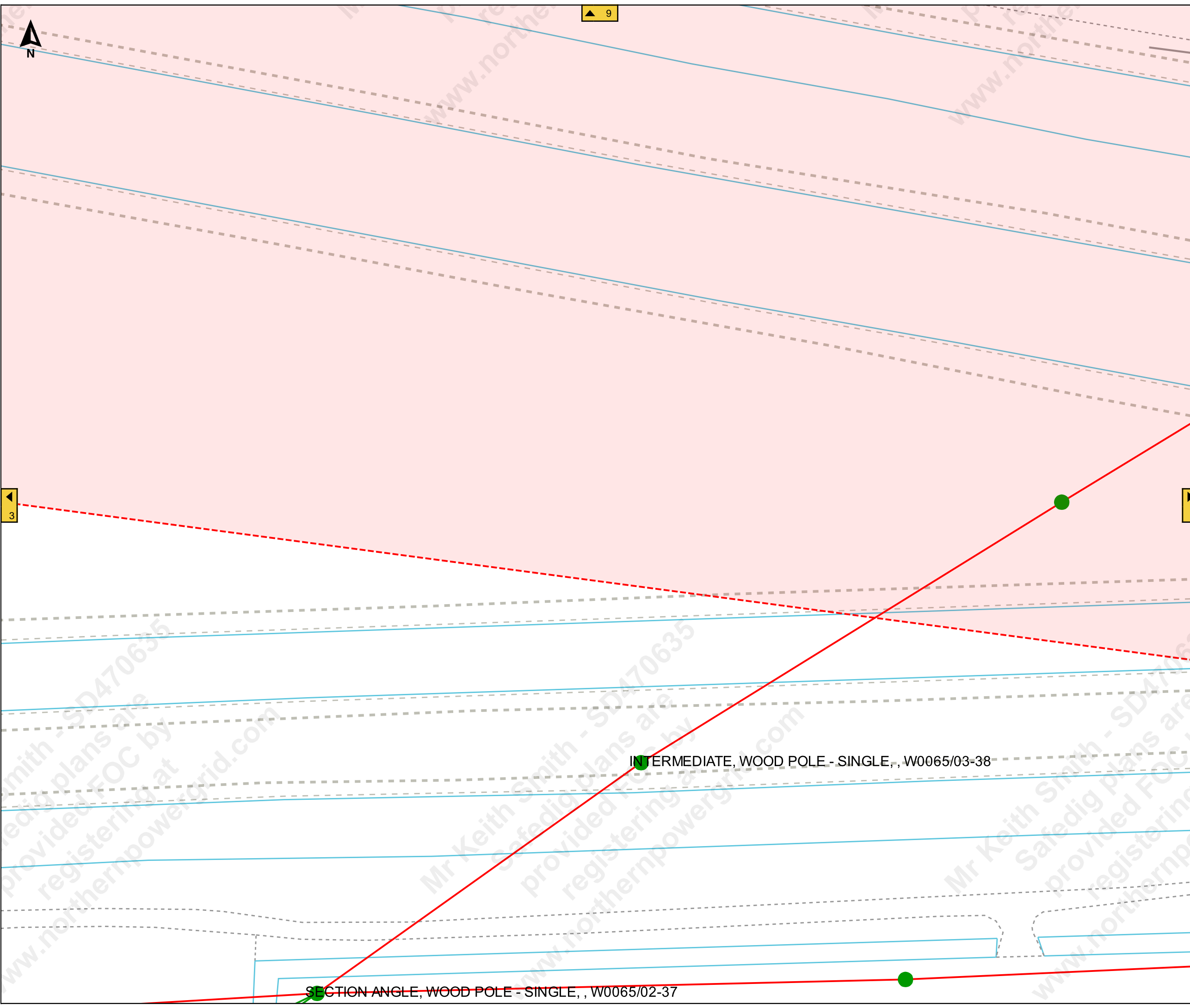
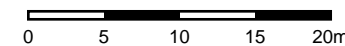

Mr Keith Smith - SD470635
Safedig plans are provided FOC by registering at www.northernpowergrid.com

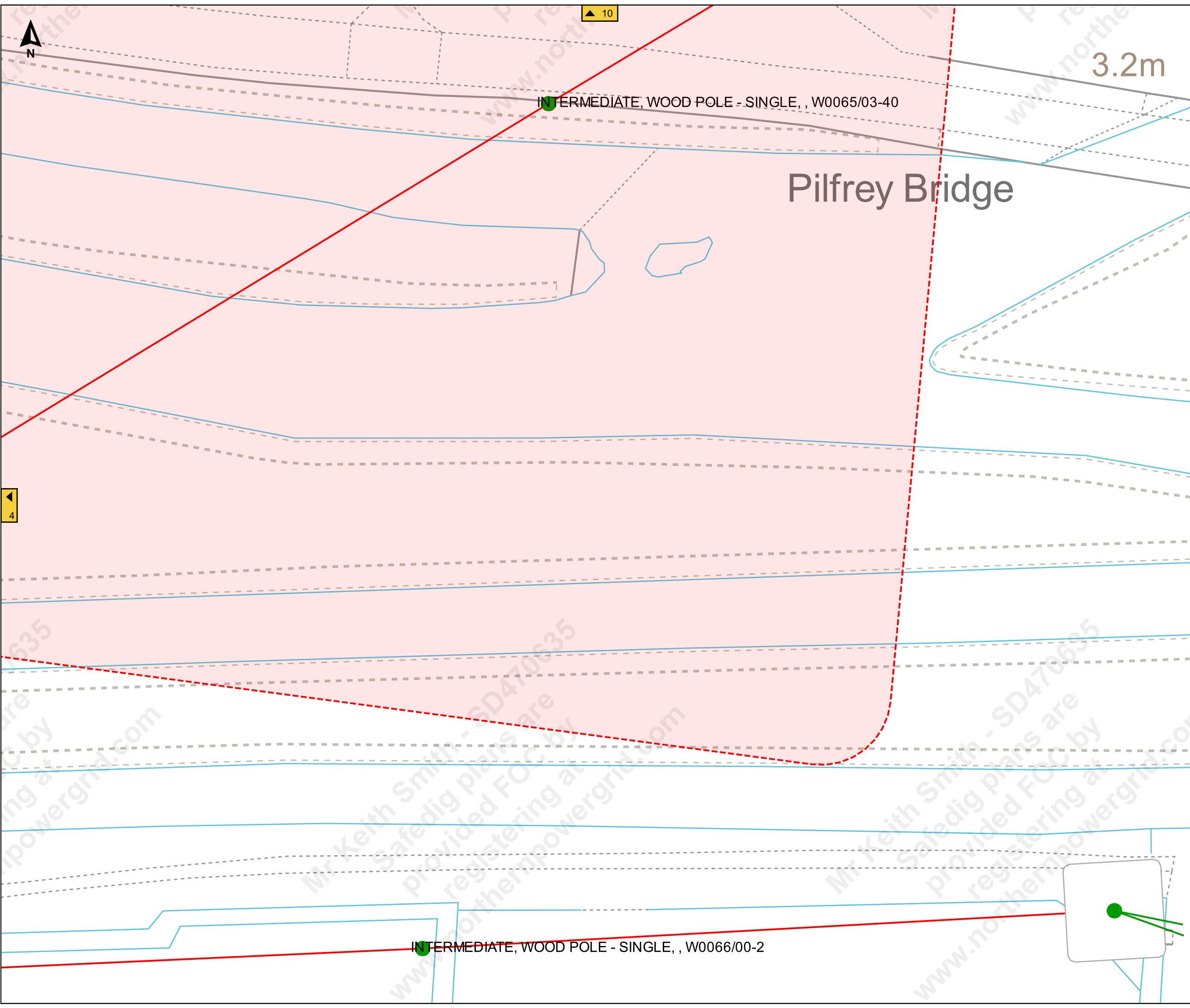

Job Reference : SD470635
1 Chesswick Crescent

Scale : 1:500

Grid Coordinates : 480750 409875

Date : 22/03/2021

Produced For :
Mr Keith Smith

Page 5 of 14 (5,14)

Terms and Conditions

Electric cables and/or overhead line information shown on the record plans are to be used in accordance with the Health & Safety Executive's Booklet HS(G)47, "Avoiding Danger from Underground Services" and Guidance Note GS 6, "Avoidance of Danger from Overhead Electric Lines". Record plans do not always show out of commission cables or service cables from Northern Powergrid's mains to adjoining or cross road properties. Plans do not show local authority owned public lighting or sign cables. The information is provided as a service by NorthernPowergrid and does not impart any legal obligation on their part. Persons using it are reminded of their responsibility to execute works safely to avoid damaging Northern Powergrid's apparatus.

Further advice or assistance is available from the Records Information Centre on 0191 2294296
In an emergency or outside normal working hours contact our customer information centre on 0800 668877
Cable depths shown were correct at the time cables were laid however alterations to ground levels or cable disposition may have taken place.

Legend:

Underground Cables:	
132kV	20kV
66kV	11kV
33kV	6kV
25kV	3kV
Left In Situ	Aux
LV Mains	LV Service
LV Service Assumed Route	
LV Service Logical Connection	
Duct Route	
Overhead Conductors:	
132kV	20kV
66kV	11kV
33kV	6kV
25kV	3kV
LV Mains	Aux
LV Service	

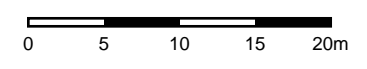

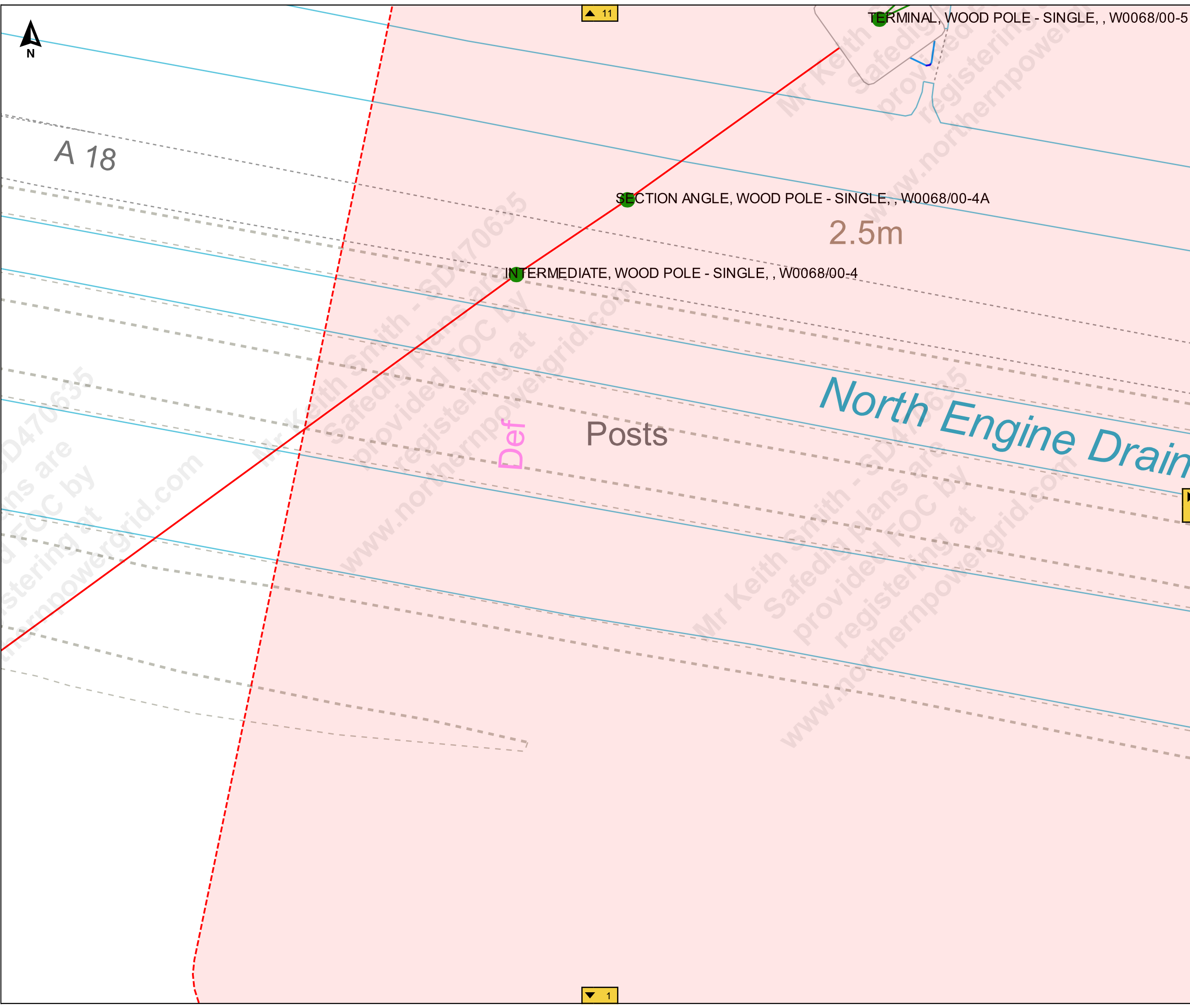

Job Reference : SD470635
 1 Chesswick Crescent

Scale : 1:500

Grid Coordinates : 480082 410014

Date : 22/03/2021

Produced For :
 Mr Keith Smith

Page 6 of 14 (6,14)

Terms and Conditions

Electric cables and/or overhead line information shown on the record plans are to be used in accordance with the Health & Safety Executive's Booklet HS(G)47, "Avoiding Danger from Underground Services" and Guidance Note GS 6, "Avoidance of Danger from Overhead Electric Lines". Record plans do not always show out of commission cables or service cables from Northern Powergrid's mains to adjoining or cross road properties. Plans do not show local authority owned public lighting or sign cables. The information is provided as a service by Northern Powergrid and does not impart any legal obligation on their part. Persons using it are reminded of their responsibility to execute works safely to avoid damaging Northern Powergrid's apparatus.

Further advice or assistance is available from the Records Information Centre on 0191 2294296
 In an emergency or outside normal working hours contact our customer information centre on 0800 668877
 Cable depths shown were correct at the time cables were laid however alterations to ground levels or cable disposition may have taken place.

Legend:

Underground Cables:	
132kV	20kV
66kV	11kV
33kV	6kV
25kV	3kV
Left In Situ	Aux
LV Mains	LV Service
LV Service Assumed Route	
LV Service Logical Connection	
Duct Route	
Overhead Conductors:	
132kV	20kV
66kV	11kV
33kV	6kV
25kV	3kV
LV Mains	Aux
LV Service	

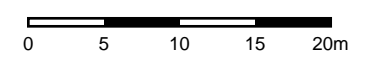



▲ 12



Job Reference : SD470635
1 Chesswick Crescent

Scale : 1:500

Grid Coordinates : 480249 410014

Date : 22/03/2021

Produced For :
Mr Keith Smith

Page 7 of 14 (7,14)

Terms and Conditions

Electric cables and/or overhead line information shown on the record plans are to be used in accordance with the Health & Safety Executive's Booklet HS(G)47, "Avoiding Danger from Underground Services" and Guidance Note GS 6, "Avoidance of Danger from Overhead Electric Lines". Record plans do not always show out of commission cables or service cables from Northern Powergrid's mains to adjoining or cross road properties. Plans do not show local authority owned public lighting or sign cables. The information is provided as a service by Northern Powergrid and does not impart any legal obligation on their part. Persons using it are reminded of their responsibility to execute works safely to avoid damaging Northern Powergrid's apparatus.

Further advice or assistance is available from the Records Information Centre on 0191 2294296
In an emergency or outside normal working hours contact our customer information centre on 0800 668877
Cable depths shown were correct at the time cables were laid however alterations to ground levels or cable disposition may have taken place.

Ward Bdy

SD

2.6m

◀ 6

▶ 8

▼ 2

Legend:

- Underground Cables:**
- 132kV
 - 66kV
 - 33kV
 - 25kV
 - Left In Situ
 - LV Mains
 - LV Service Assumed Route
 - LV Service Logical Connection
 - Duct Route
 - 20kV
 - 11kV
 - 6kV
 - 3kV
 - Aux
 - LV Service
- Overhead Conductors:**
- 132kV
 - 66kV
 - 33kV
 - 25kV
 - LV Mains
 - LV Service
 - 20kV
 - 11kV
 - 6kV
 - 3kV
 - Aux

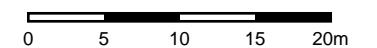

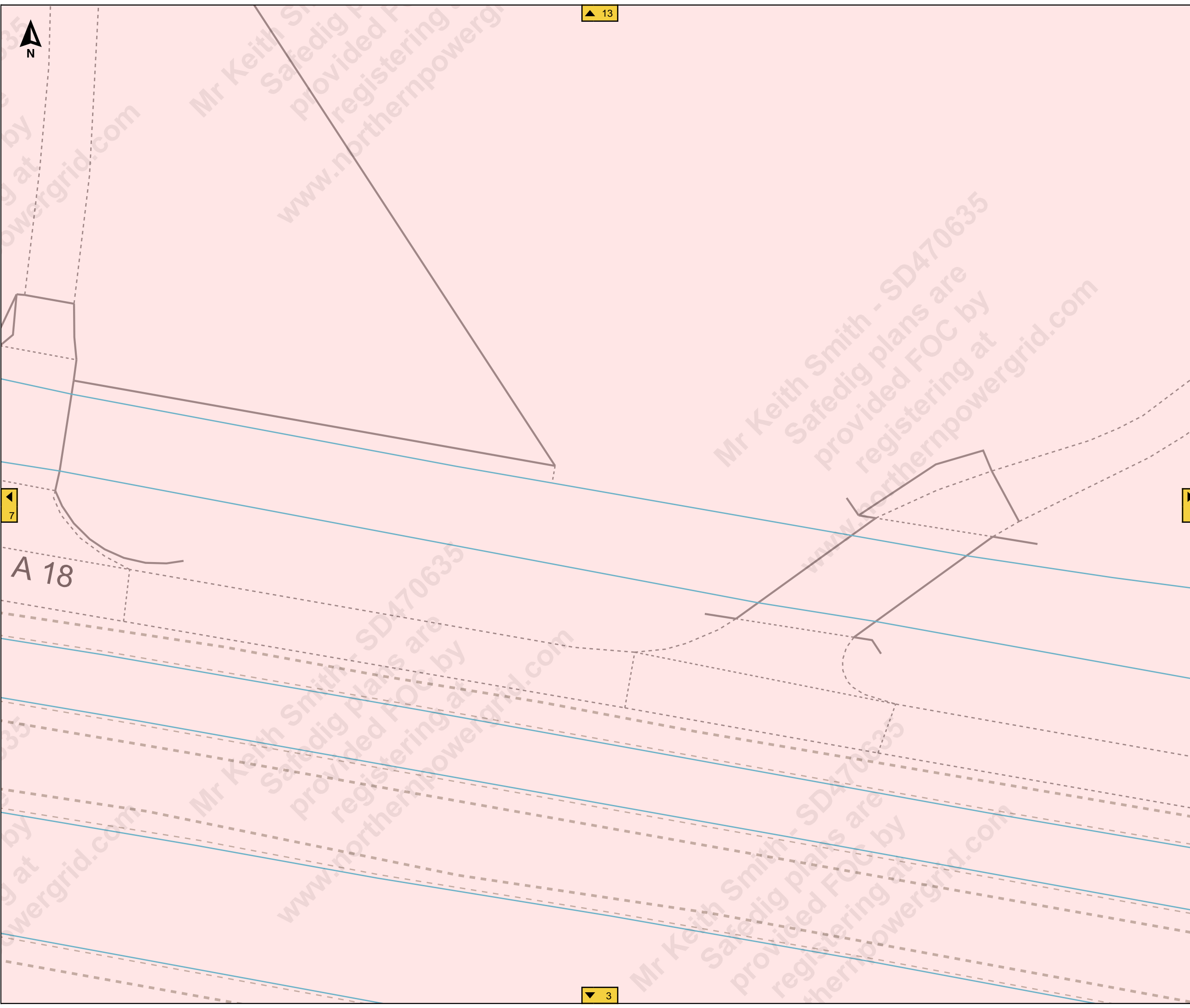

Job Reference : SD470635
1 Chesswick Crescent

Scale : 1:500

Grid Coordinates : 480416 410014

Date : 22/03/2021

Produced For :
Mr Keith Smith

Page 8 of 14 (8,14)

Terms and Conditions

Electric cables and/or overhead line information shown on the record plans are to be used in accordance with the Health & Safety Executive's Booklet HS(G)47, "Avoiding Danger from Underground Services" and Guidance Note GS 6, "Avoidance of Danger from Overhead Electric Lines". Record plans do not always show out of commission cables or service cables from Northern Powergrid's mains to adjoining or cross road properties. Plans do not show local authority owned public lighting or sign cables. The information is provided as a service by NorthernPowergrid and does not impart any legal obligation on their part. Persons using it are reminded of their responsibility to execute works safely to avoid damaging Northern Powergrid's apparatus.

Further advice or assistance is available from the Records Information Centre on 0191 2294296
In an emergency or outside normal working hours contact our customer information centre on 0800 668877
Cable depths shown were correct at the time cables were laid however alterations to ground levels or cable disposition may have taken place.

Legend:

Underground Cables:	
132kV	20kV
66kV	11kV
33kV	6kV
25kV	3kV
Left In Situ	Aux
LV Mains	LV Service
LV Service Assumed Route	
LV Service Logical Connection	
Duct Route	
Overhead Conductors:	
132kV	20kV
66kV	11kV
33kV	6kV
25kV	3kV
LV Mains	Aux
LV Service	

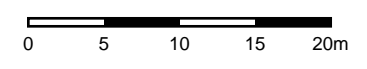



Job Reference : SD470635

1 Chesswick Crescent

Scale : 1:500

Grid Coordinates : 480583 410014

Date : 22/03/2021

Produced For :
Mr Keith Smith

Page 9 of 14 (9,14)

Terms and Conditions

Electric cables and/or overhead line information shown on the record plans are to be used in accordance with the Health & Safety Executive's Booklet HS(G)47, "Avoiding Danger from Underground Services" and Guidance Note GS 6, "Avoidance of Danger from Overhead Electric Lines". Record plans do not always show out of commission cables or service cables from Northern Powergrid's mains to adjoining or cross road properties. Plans do not show local authority owned public lighting or sign cables. The information is provided as a service by NorthernPowergrid and does not impart any legal obligation on their part. Persons using it are reminded of their responsibility to execute works safely to avoid damaging Northern Powergrid's apparatus.

Further advice or assistance is available from the Records Information Centre on 0191 2294296
In an emergency or outside normal working hours contact our customer information centre on 0800 668877
Cable depths shown were correct at the time cables were laid however alterations to ground levels or cable disposition may have taken place.

Legend:

- Underground Cables:**
- 132kV
 - 66kV
 - 33kV
 - 25kV
 - Left In Situ
 - LV Mains
 - LV Service Assumed Route
 - LV Service Logical Connection
 - Duct Route
 - 20kV
 - 11kV
 - 6kV
 - 3kV
 - Aux
 - LV Service
- Overhead Conductors:**
- 132kV
 - 66kV
 - 33kV
 - 25kV
 - LV Mains
 - LV Service
 - 20kV
 - 11kV
 - 6kV
 - 3kV
 - Aux

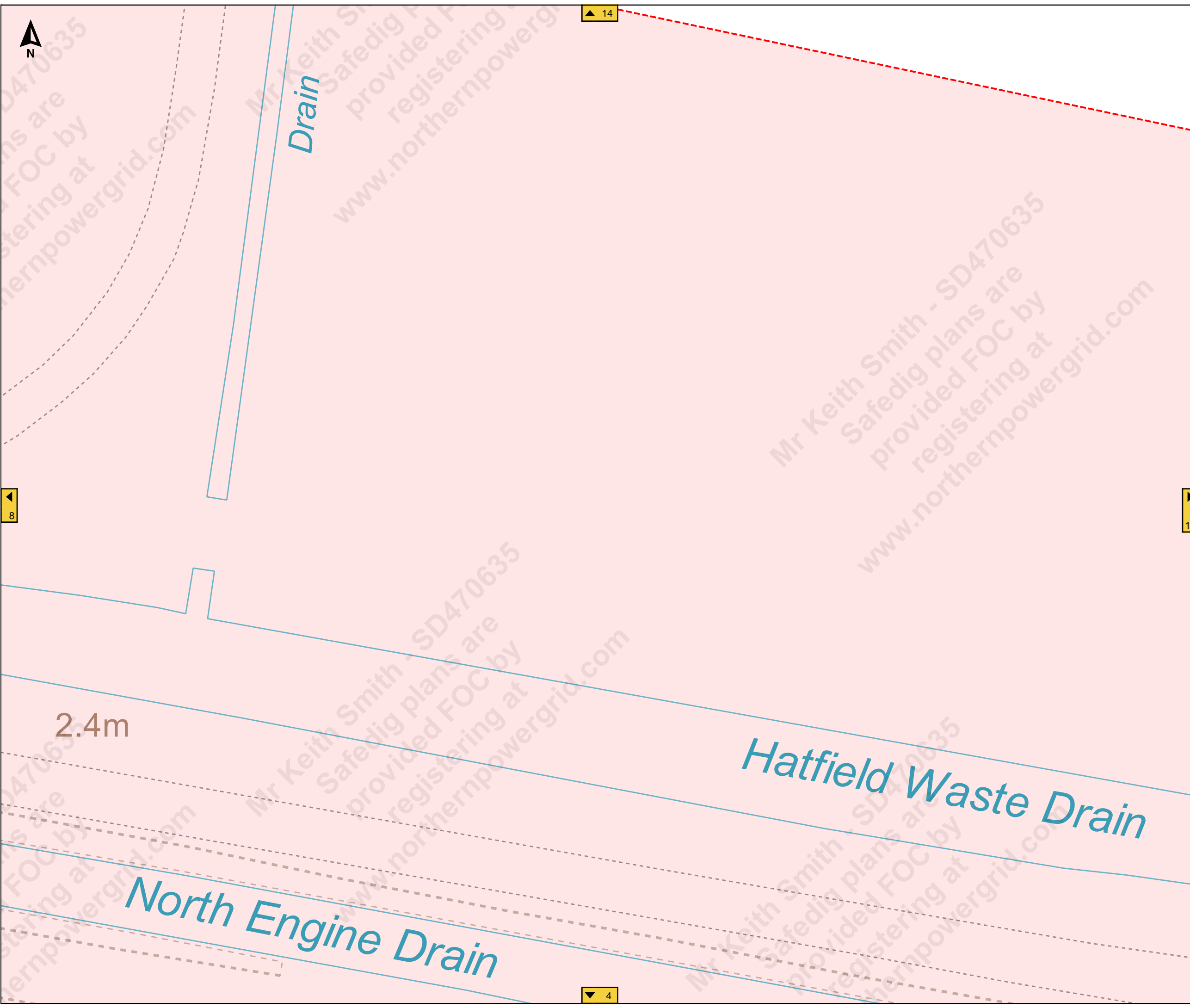
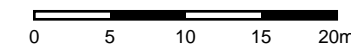

8

14

10

4

Job Reference : SD470635

1 Chesswick Crescent

Scale : 1:500

Grid Coordinates : 480750 410014

Date : 22/03/2021

Produced For :
Mr Keith Smith

Page 10 of 14 (10,14)

Terms and Conditions

Electric cables and/or overhead line information shown on the record plans are to be used in accordance with the Health & Safety Executive's Booklet HS(G)47, "Avoiding Danger from Underground Services" and Guidance Note GS 6, "Avoidance of Danger from Overhead Electric Lines". Record plans do not always show out of commission cables or service cables from Northern Powergrid's mains to adjoining or cross road properties. Plans do not show local authority owned public lighting or sign cables. The information is provided as a service by NorthernPowergrid and does not impart any legal obligation on their part. Persons using it are reminded of their responsibility to execute works safely to avoid damaging Northern Powergrid's apparatus.

Further advice or assistance is available from the Records Information Centre on 0191 2294296

In an emergency or outside normal working hours contact our customer information centre on 0800 668877

Cable depths shown were correct at the time cables were laid however alterations to ground levels or cable disposition may have taken place.

Legend:

Underground Cables:	
132kV	20kV
66kV	11kV
33kV	6kV
25kV	3kV
Left In Situ	Aux
LV Mains	LV Service
LV Service Assumed Route	
LV Service Logical Connection	
Duct Route	
Overhead Conductors:	
132kV	20kV
66kV	11kV
33kV	6kV
25kV	3kV
LV Mains	Aux
LV Service	

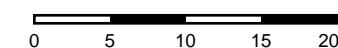

Pilfrey Farm

Ward Bdy

2.3m

SD



9

5

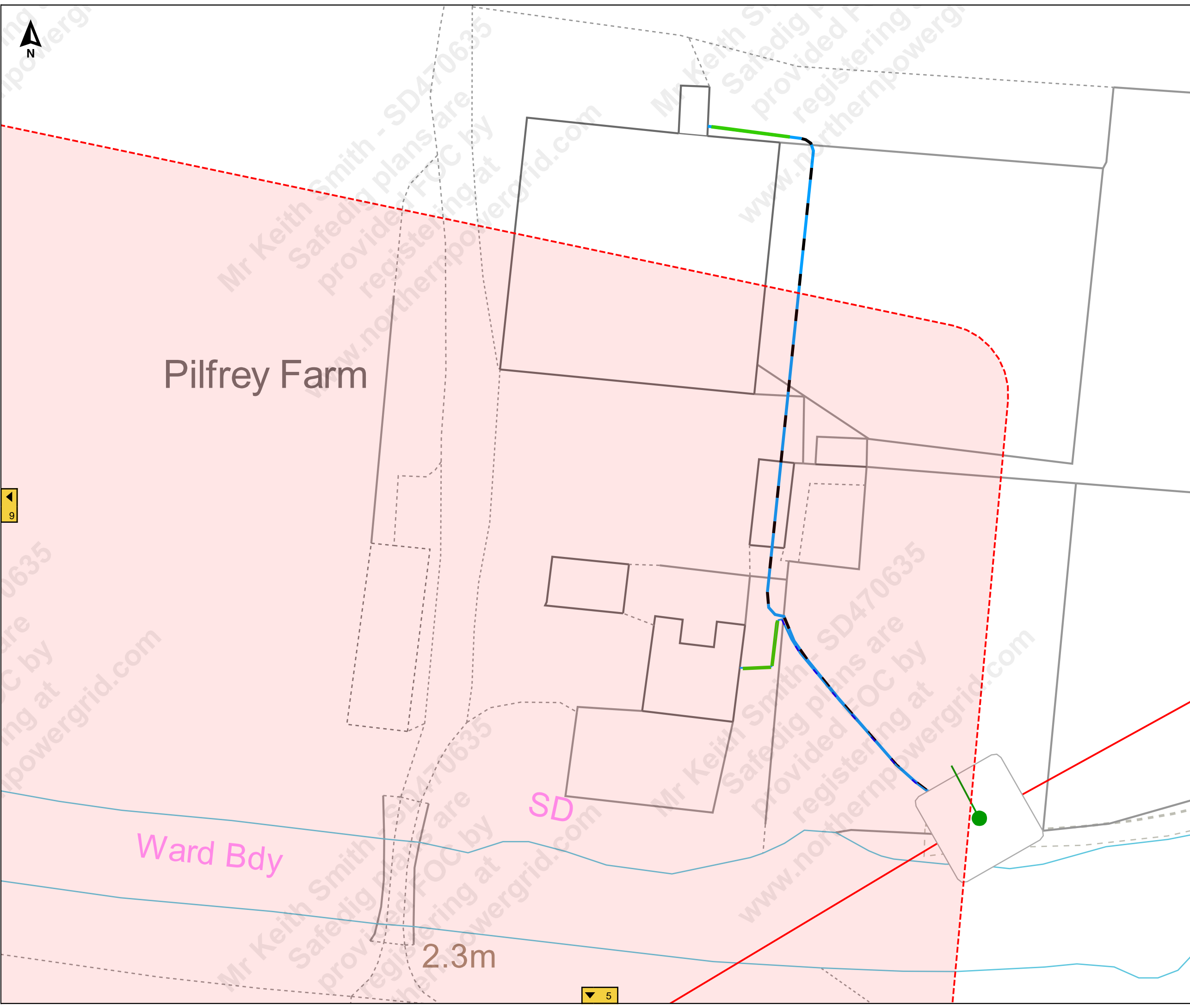



Job Reference : SD470635

1 Chesswick Crescent

Scale : 1:500

Grid Coordinates : 480082 410153

Date : 22/03/2021

Produced For :
Mr Keith Smith

Page 11 of 14 (11,14)

Terms and Conditions

Electric cables and/or overhead line information shown on the record plans are to be used in accordance with the Health & Safety Executive's Booklet HS(G)47, "Avoiding Danger from Underground Services" and Guidance Note GS 6, "Avoidance of Danger from Overhead Electric Lines". Record plans do not always show out of commission cables or service cables from Northern Powergrid's mains to adjoining or cross road properties. Plans do not show local authority owned public lighting or sign cables. The information is provided as a service by NorthernPowergrid and does not impart any legal obligation on their part. Persons using it are reminded of their responsibility to execute works safely to avoid damaging Northern Powergrid's apparatus.

Further advice or assistance is available from the Records Information Centre on 0191 2294296
In an emergency or outside normal working hours contact our customer information centre on 0800 668877
Cable depths shown were correct at the time cables were laid however alterations to ground levels or cable disposition may have taken place.

Legend:

Underground Cables:	
132kV	20kV
66kV	11kV
33kV	6kV
25kV	3kV
Left In Situ	Aux
LV Mains	LV Service
LV Service Assumed Route	
LV Service Logical Connection	
Duct Route	
Overhead Conductors:	
132kV	20kV
66kV	11kV
33kV	6kV
25kV	3kV
LV Mains	Aux
LV Service	

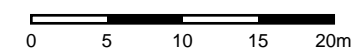

12

6

TERMINAL, WOOD POLE - SINGLE, , W0068/00-5

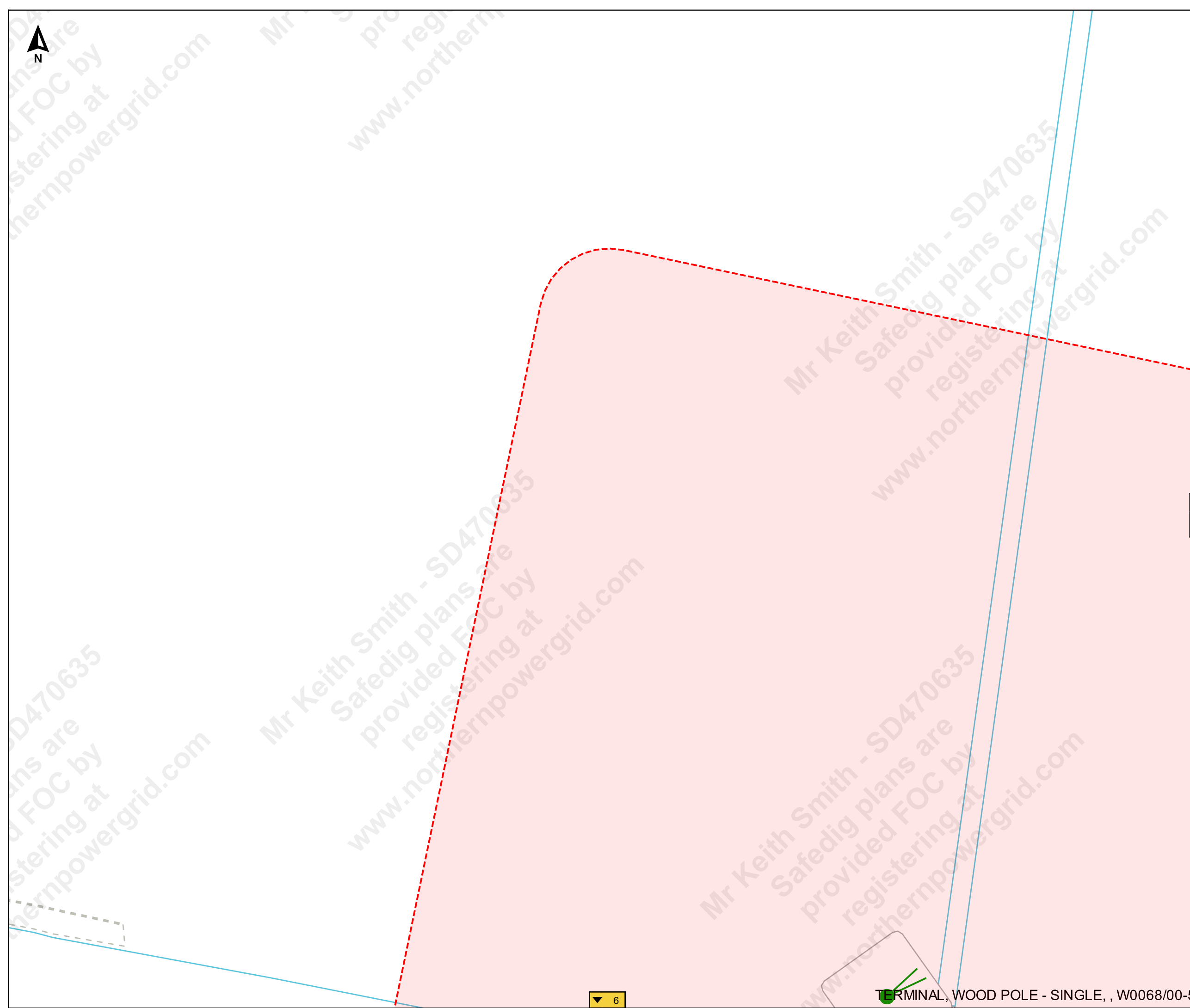



Job Reference : SD470635
1 Chesswick Crescent

Scale : 1:500

Grid Coordinates : 480249 410153

Date : 22/03/2021

Produced For :
Mr Keith Smith

Page 12 of 14 (12,14)

Terms and Conditions

Electric cables and/or overhead line information shown on the record plans are to be used in accordance with the Health & Safety Executive's Booklet HS(G)47, "Avoiding Danger from Underground Services" and Guidance Note GS 6, "Avoidance of Danger from Overhead Electric Lines". Record plans do not always show out of commission cables or service cables from Northern Powergrid's mains to adjoining or cross road properties. Plans do not show local authority owned public lighting or sign cables. The information is provided as a service by NorthernPowergrid and does not impart any legal obligation on their part. Persons using it are reminded of their responsibility to execute works safely to avoid damaging Northern Powergrid's apparatus.

Further advice or assistance is available from the Records Information Centre on 0191 2294296
In an emergency or outside normal working hours contact our customer information centre on 0800 668877
Cable depths shown were correct at the time cables were laid however alterations to ground levels or cable disposition may have taken place.

Legend:

- Underground Cables:**
- 132kV
 - 66kV
 - 33kV
 - 25kV
 - Left In Situ
 - LV Mains
 - LV Service Assumed Route
 - LV Service Logical Connection
 - Duct Route
 - 20kV
 - 11kV
 - 6kV
 - 3kV
 - Aux
 - LV Service
- Overhead Conductors:**
- 132kV
 - 66kV
 - 33kV
 - 25kV
 - LV Mains
 - LV Service
 - 20kV
 - 11kV
 - 6kV
 - 3kV
 - Aux

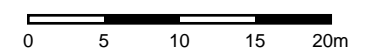

Mr Keith Smith - SD470635
Safedig plans are provided FOC by registering at www.northernpowergrid.com

11

13

7

Job Reference : SD470635
1 Chesswick Crescent

Scale : 1:500

Grid Coordinates : 480416 410153

Date : 22/03/2021

Produced For :
Mr Keith Smith

Page 13 of 14 (13,14)

Terms and Conditions

Electric cables and/or overhead line information shown on the record plans are to be used in accordance with the Health & Safety Executive's Booklet HS(G)47, "Avoiding Danger from Underground Services" and Guidance Note GS 6, "Avoidance of Danger from Overhead Electric Lines". Record plans do not always show out of commission cables or service cables from Northern Powergrid's mains to adjoining or cross road properties. Plans do not show local authority owned public lighting or sign cables. The information is provided as a service by NorthernPowergrid and does not impart any legal obligation on their part. Persons using it are reminded of their responsibility to execute works safely to avoid damaging Northern Powergrid's apparatus.

Further advice or assistance is available from the Records Information Centre on 0191 2294296
In an emergency or outside normal working hours contact our customer information centre on 0800 668877
Cable depths shown were correct at the time cables were laid however alterations to ground levels or cable disposition may have taken place.

Legend:

Underground Cables:	
132kV	20kV
66kV	11kV
33kV	6kV
25kV	3kV
Left In Situ	Aux
LV Mains	LV Service
LV Service Assumed Route	
LV Service Logical Connection	
Duct Route	
Overhead Conductors:	
132kV	20kV
66kV	11kV
33kV	6kV
25kV	3kV
LV Mains	Aux
LV Service	

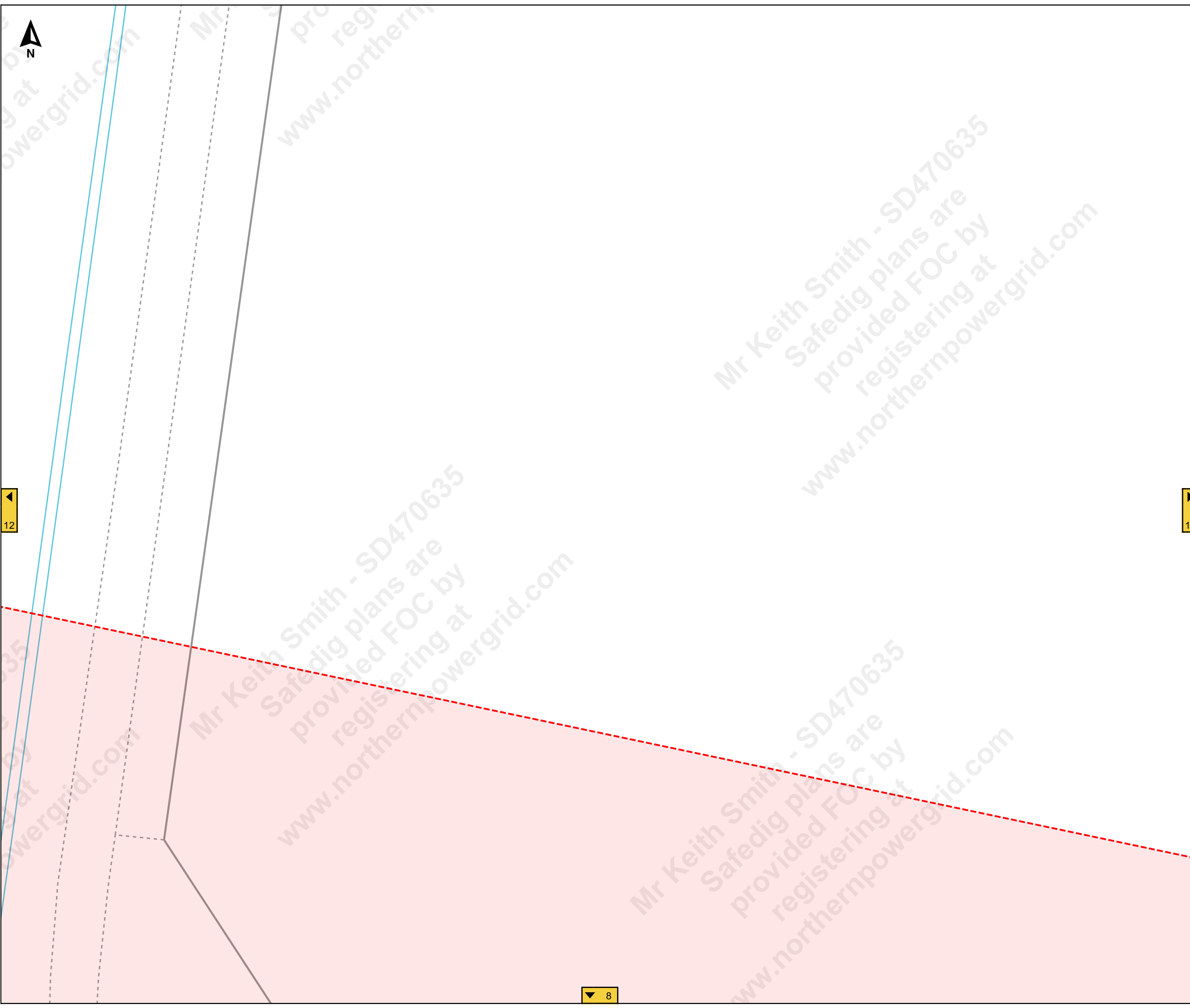
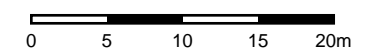



Drain



Job Reference : SD470635
1 Chesswick Crescent

Scale : 1:500

Grid Coordinates : 480583 410153

Date : 22/03/2021

Produced For :
Mr Keith Smith

Page 14 of 14 (14,14)

Terms and Conditions

Electric cables and/or overhead line information shown on the record plans are to be used in accordance with the Health & Safety Executive's Booklet HS(G)47, "Avoiding Danger from Underground Services" and Guidance Note GS 6, "Avoidance of Danger from Overhead Electric Lines". Record plans do not always show out of commission cables or service cables from Northern Powergrid's mains to adjoining or cross road properties. Plans do not show local authority owned public lighting or sign cables. The information is provided as a service by NorthernPowergrid and does not impart any legal obligation on their part. Persons using it are reminded of their responsibility to execute works safely to avoid damaging Northern Powergrid's apparatus.

Further advice or assistance is available from the Records Information Centre on 0191 2294296
In an emergency or outside normal working hours contact our customer information centre on 0800 668877
Cable depths shown were correct at the time cables were laid however alterations to ground levels or cable disposition may have taken place.

Legend:

- Underground Cables:**
- 132kV
 - 66kV
 - 33kV
 - 25kV
 - Left In Situ
 - LV Mains
 - LV Service Assumed Route
 - LV Service Logical Connection
 - Duct Route
 - 20kV
 - 11kV
 - 6kV
 - 3kV
 - Aux
 - LV Service
- Overhead Conductors:**
- 132kV
 - 66kV
 - 33kV
 - 25kV
 - LV Mains
 - LV Service
 - 20kV
 - 11kV
 - 6kV
 - 3kV
 - Aux

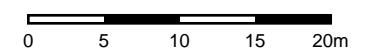

Mr Keith Smith - SD470635
Safedig plans are provided FOC by registering at www.northernpowergrid.com

Mr Keith Smith - SD470635
Safedig plans are provided FOC by registering at www.northernpowergrid.com

Mr Keith Smith - SD470635
Safedig plans are provided FOC by registering at www.northernpowergrid.com

Mr Keith Smith - SD470635
Safedig plans are provided FOC by registering at www.northernpowergrid.com

Mr Keith Smith - SD470635
Safedig plans are provided FOC by registering at www.northernpowergrid.com

13

9

keith smith
Apogee Utility Consultants
Blount House
Hall Court
Hall Park Way
Telford
Telford
Shropshire

Date: 22/03/2021
Our Ref: EM_GE1A_3SWX_801870
Your Ref: 422015
RE: Proposed Works, A18

Thank you for your enquiry which was received on 22/03/2021.
Please note this response and any attached map(s) are valid for 28 days.

An assessment has been carried out with respect to Cadent Gas Limited, National Grid Electricity Transmission plc's and National Grid Gas Transmission plc's apparatus. Please note it does not cover the items listed in the section "Your Responsibilities and Obligations", including gas service pipes and related apparatus. For details of Network areas please see the Cadent website (<http://cadentgas.com/Digging-safely/Dial-before-you-dig>) or the enclosed documentation.

As your works are at a "proposed" stage, any maps and guidance provided are for information purposes only. This is not approval to commence work. You must submit a "Scheduled Works" enquiry at the earliest opportunity and failure to do this may lead to disruption to your plans and works. Plant Protection will endeavour to provide an initial assessment within 14 days of receipt of a Scheduled Works enquiry and dependent on the outcome of this, further consultation may be required.

In any event, for safety and legal reasons, works must not be carried out until a Scheduled Works enquiry has been completed and final response received.

Plant Protection
Cadent
Block 1; Floor 1
Brick Kiln Street
Hinckley
LE10 0NA
E-mail: plantprotection@cadentgas.com
Telephone: +44 (0)800 688588

National Gas Emergency Number:
0800 111 999*

National Grid Electricity Emergency Number:
0800 40 40 90*

* Available 24 hours, 7 days/week.
Calls may be recorded and monitored.

www.cadentgas.com

Your Responsibilities and Obligations

The "Assessment" Section below outlines the detailed requirements that must be followed when planning or undertaking your scheduled activities at this location.

It is your responsibility to ensure that the information you have submitted is accurate and that all relevant documents including links are provided to all persons (either direct labour or contractors) working for you near Cadent and/or National Grid's apparatus, e.g. as contained within the Construction (Design and Management) Regulations.

This assessment solely relates to Cadent Gas Limited, National Grid Electricity Transmission plc (NGET) and National Grid Gas Transmission plc (NGGT) and apparatus. This assessment does **NOT** include:

- | Cadent and/or National Grid's legal interest (easements or wayleaves) in the land which restricts activity in proximity to Cadent and/or National Grid's assets in private land. You must obtain details of any such restrictions from the landowner in the first instance and if in doubt contact Plant Protection.
- | Gas service pipes and related apparatus
- | Recently installed apparatus
- | Apparatus owned by other organisations, e.g. other gas distribution operators, local electricity companies, other utilities, etc.

It is **YOUR** responsibility to take into account whether the items listed above may be present and if they could be affected by your proposed activities. Further "Essential Guidance" in respect of these items can be found on either the [National Grid](#) or [Cadent](#) website.

This communication does not constitute any formal agreement or consent for any proposed development work; either generally or with regard to Cadent and/or National Grid's easements or wayleaves nor any planning or building regulations applications.

Cadent Gas Limited, NGGT and NGET or their agents, servants or contractors do not accept any liability for any losses arising under or in connection with this information. This limit on liability applies to all and any claims in contract, tort (including negligence), misrepresentation (excluding fraudulent misrepresentation), breach of statutory duty or otherwise. This limit on liability does not exclude or restrict liability where prohibited by the law nor does it supersede the express terms of any related agreements.

If you require further assistance please contact the Plant Protection team via e-mail ([click here](#)) or via the contact details at the top of this response.

Yours faithfully

Plant Protection Team

ASSESSMENT

Affected Apparatus

The apparatus that has been identified as being in the vicinity of your proposed works is:

- | National Gas Transmission Pipelines and associated equipment

Requirements

BEFORE carrying out any work you must:

- | Carefully read these requirements including the attached guidance documents and maps showing the location of apparatus.
- | Contact the landowner and ensure any proposed works in private land do not infringe Cadent and/or National Grid's legal rights (i.e. easements or wayleaves). If the works are in the road or footpath the relevant local authority should be contacted.
- | Ensure that all persons, including direct labour and contractors, working for you on or near Cadent and/or National Grid's apparatus follow the requirements of the HSE Guidance Notes HSG47 - 'Avoiding Danger from Underground Services' and GS6 – 'Avoidance of danger from overhead electric power lines'. This guidance can be downloaded free of charge at <http://www.hse.gov.uk>
- | In line with the above guidance, verify and establish the actual position of mains, pipes, cables, services and other apparatus on site before any activities are undertaken.

GUIDANCE

High Pressure Gas Pipelines Guidance:

If working in the vicinity of a high pressure gas pipeline the following document must be followed: 'Specification for Safe Working in the Vicinity of Cadent and/or National Grid High Pressure Gas Pipelines and Associated Installations - Requirements for Third Parties' (SSW22). This can be obtained from: <http://www2.nationalgrid.com/WorkArea/DownloadAsset.aspx?id=33968>

National High Pressure Gas Pipelines Guidance:

<http://www.nationalgrid.com/NR/rdonlyres/9934F173-04D0-48C4-BE4D-82294822D29C/51893/Above7barGasGuidance.pdf>

Dial Before You Dig Pipelines Guidance:

<http://www2.nationalgrid.com/WorkArea/DownloadAsset.aspx?id=33969>

Standard Guidance

Essential Guidance document:

<http://www2.nationalgrid.com/WorkArea/DownloadAsset.aspx?id=8589934982>

General Guidance document:

<http://www2.nationalgrid.com/WorkArea/DownloadAsset.aspx?id=35103>

Excavating Safely in the vicinity of gas pipes guidance (Credit card):

<http://www.nationalgrid.com/NR/rdonlyres/A3D37677-6641-476C-9DDA-E89949052829/44257/ExcavatingSafelyCreditCard.pdf>

Excavating Safely in the vicinity of electricity cables guidance (Credit card):

<http://www.nationalgrid.com/NR/rdonlyres/35DDEC6D-D754-4BA5-AF3C-D607D05A25C2/44858/ExcavatingSafelyCreditCardelectricitycables.pdf>

Copies of all the Guidance Documents can also be downloaded from the [National Grid](#) and [Cadent](#) websites.



ID: EM_GE1A_3SWX_801870
 USER: keith smith
 DATE: 22/03/2021
 DATA DATE: 21/03/2021
 REF: 422015
 MAP REF: SE8010
 CENTRE: 480426, 410008

View extent: 2890m, 1570m

LP MAINS	
MP MAINS	
IP MAINS	
LHP MAINS	
NHP MAINS	

0m 200m
 Approximate scale 1:10000
 on A4 Colour Landscape

Map not to be used for construction

This plan shows those pipes owned by Cadent Gas Limited in its role as a Licensed Gas Transporter (GT). Gas pipes owned by other GTs, or otherwise privately owned, may be present in this area. Information with regard to such pipes should be obtained from the relevant owners. The information shown on this plan is given without warranty, the accuracy thereof cannot be guaranteed. Service pipes, valves, syphons, stub connections, etc., are not shown but their presence should be anticipated. No liability of any kind whatsoever is accepted by Cadent Gas Limited or their agents, servants or contractors for any error or omission. Safe digging practices, in accordance with HS(G)47, must be used to verify and establish the actual position of mains, pipes, services and other apparatus on site before any mechanical plant is used. It is your responsibility to ensure that this information is provided to all persons (either direct labour or contractors) working for you on or near gas apparatus. The information included on this plan should not be referred to beyond a period of 28 days from the date of issue.

Map 1 of 1 (GAS)

MAPS Plot Server Version 1.11.0

Your Gas Network

Requested by: Apogee Utility Consultants

This plan is reproduced from or based on the OS map by Cadent Gas Limited, with the sanction of the controller of HM Stationery Office. Crown Copyright Reserved. Ordnance Survey Licence number 100024886

Some examples of Plant Items:

Valve	Depth of Cover	Syphon	Diameter Change	Material Change	Out of Standard Service

ENQUIRY SUMMARY

Received Date

22/03/2021

Your Reference

422015

Location

Centre Point: 480426, 410008

X Extent: 700

Y Extent: 375

Postcode: DN17 4DA

Location Description: A18

Map Options

Paper Size: A4

Orientation: LANDSCAPE

Requested Scale: 2500

Actual Scale: 1:10000 (GAS)

Real World Extents: 2890m x 1570m (GAS)

Recipients

keith.smith@apogeeutilityconsultants.co.uk

Enquirer Details

Organisation Name: Apogee Utility Consultants

Contact Name: keith smith

Email Address: keith.smith@apogeeutilityconsultants.co.uk

Telephone: 01952686572 (07811923927)

Address: Blount House, Hall Court, Hall Park Way, Telford, Telford, Shropshire, TF3 4NQ

Description of Works

Utility Work

Enquiry Type

Proposed Works

Activity Type

Utility Works

Work Types

Work Type: Plans Only

SEE SKETCH
FD07/1000/A

PARROT-CROSSBERRY TREES (NEST)

FEDER 7 13020000

1125 & 450EG SIB BEHNS
SEE SKETCH FD07/1000/A

225 & 450EG OVER BEHNS

CP15

Drain

Palfrey Farm

CROSSING IN/3 AIR ROAD, DRAIN & RIVER TORNE
SIB No. BOP/OP/1/7. SHEETS 162
60" DIA. SLEEVE 29m LONG SEGMENTED CONCRETE TUNNEL
COVER 13.55-13.75m

CP14

SCALE: Not to scale
USER ID: KeithSmith
DATE: 09/04/2021
EXTRACT DATE: 01/12/2020
MAP REF: SE8010
CENTRE: 480327, 410014

LP MAINS	
MP MAINS	
IP MAINS	
LHP MAINS	

This plan shows those pipes owned by Cadent Gas Ltd in their role as a Licensed Gas Transporter (GT). Gas pipes owned by other GTs, or otherwise privately owned, may be present in this area. Information with regard to such pipes should be obtained from the relevant owners. The information shown on this plan is given without warranty, the accuracy thereof cannot be guaranteed. Service pipes, valves, syphons, stub connections, etc. are not shown but their presence should be anticipated. No liability of any kind whatsoever is accepted by Cadent Gas Ltd or their agents, servants or contractors for any error or omission. Safe digging practices, in accordance with HS(G)47, must be used to verify and establish the actual position of mains, pipes, services and other apparatus on site before any mechanical plant is used. It is your responsibility to ensure that this information is provided to all persons (either direct labour or contractors) working for you on or near gas apparatus. The information included on this plan should not be referred to beyond a period of 28 days from the date of issue. Further information on all DR4s can be determined by calling the DR4 hotline on 01455 892426 (9am-5pm) A DR4 is where a potential error has been identified within the asset record and a process is currently underway to investigate and resolve the error as appropriate.

MAPS Viewer Version 5.8.0.1

Local Machine

This plan is reproduced from or based on the OS map by Cadent Gas Ltd, with the sanction of the controller of HM Stationery Office. Crown Copyright Reserved.

Some examples of Plant Items:

--	--	--	--	--	--

YORKSHIRE WATER PROTECTION OF MAINS AND SERVICES

1. The position of Yorkshire Water Services Ltd (YWS) apparatus shown on the existing mains record drawing(s) indicates the **general** position and nature of our apparatus and the accuracy of this information cannot be guaranteed. Any damage to YWS apparatus as a result of your works may have serious consequences and you will be held responsible for all costs incurred. Prior to commencing major works, the exact location of apparatus must be determined on site, if necessary by excavating trial holes. The actual position of such apparatus and that of service pipes which have not been indicated must be established on site by contacting the Customer Helpline on 0845 124 24 24 for both water and sewerage.
2. The public sewer and water network is lawfully retained in its existing position and the sewerage and water undertaker is entitled to have it remain so without any disturbance. The provisions of section 159 of the Water Industry Act 1991 provides that the undertaker may "inspect, maintain, adjust, repair or alter" the network. Those rights are given to enable the undertaker to perform its statutory duties. Any development of the land or any other action that unacceptably hindered the exercise of those rights would be unlawful. The provisions contained in Section 185 of the Water Industry Act 1991 state that where it is reasonable to do so, a person may require the water supply undertaker to alter or remove a pipe where it is necessary to enable that person to carry out a proposed change of use of the land. The provisions contained in Section 185 also require the person making the request to pay the full cost of carrying out the necessary works.
3. Ground levels over existing YWS apparatus are to be maintained. Sewers in highways will **generally** be laid to give 1200mm of cover from finished ground level working to kerb races, other permanent identification of the limits of the road or to an agreed line and level. Substantial increases or decreases to this 1200mm depth of cover will result in the sewer being re-laid at your expense. Water mains and services will **generally** be laid with a minimum of 750mm depth of cover however some mains and services usually those installed over 50 years ago may have less ground cover.
4. If surface levels are to be decreased / increased significantly the effects on existing water supply apparatus will be carefully considered and if any alterations are necessary, the costs of the alterations will be recharged to you in full. Outlets on fire hydrants must be no more than 300mm below the new levels and all surface boxes must be adjusted as part of the scheme.
5. To enable future repair works to be carried out without hindrance; any pipe, cable, duct, etc. installed parallel to a water main or service pipe should not be installed directly over or within 300mm of a water main or service pipe or 1000mm of a waste water asset. Where a pipe, cable, duct, etc. crosses a main or service it should preferably cross perpendicular or at an angle of no less than 45° and with a minimum clearance of 150mm. These requirements apply to activities within an existing highway and are relevant to the installation of pipes, cables, ducts, etc. up to and including 250mm in diameter (*see illustration below*). Necessary protection measures for installations greater than 250mm in diameter and/or in private land will need to be agreed on an individual basis. Installations within a new development site must comply with the National Joint Utilities Group publication Volume 2: NJUG Guidelines On The Positioning Of Underground Utilities Apparatus For New Development Sites.
6. All excavation works near to YW apparatus should be by hand digging only.
7. Backfilling with a suitable material to a minimum 300mm above YW apparatus is required.
8. Adequate support must be provided where any works pass under YW apparatus.
9. Jointing chambers, lighting columns and other structures must be installed in such a way that future repair or maintenance works to YW apparatus will not be hindered.
10. Apparatus such as; railings, sign posts, etc. must not be placed in such a way that they prevent access to or full operation of controlling valves, hydrants or similar apparatus. YWS surface boxes must not be covered or buried. Any adjustment, alteration or replacement of manhole covers must be agreed on site prior to the commencement of the works with a YWS Inspector who may be contacted via our Call Centre on 0845 124 24 24.
11. Explosives shall not be used within 100 metres of any Yorkshire Water Services apparatus or installations.
12. Vibrating plant should not be used directly over any apparatus. Movement or operation by vehicles or heavy plant is not to be permitted in the immediate vicinity of YWS plant or apparatus unless there has been prior consultation and, if necessary, adequate protection provided without cost to YWS.
13. **Under no circumstances** should thrust boring or similar trenchless techniques commence until the actual position of the Company's mains/services along the proposed route have been confirmed by trial holes.
14. Any alterations to the highway should be notified following the procedures outlined in the New Road and Street Works Act 1991 Code of Practice; Measures Necessary Where Apparatus Is Affected By Major Works (Diversionary Works).
15. You will be held responsible for any damage or loss to YWS apparatus during and after completion of work, caused by yourselves, your servant or agent. Any damage caused or observed to YWS plant or apparatus should be immediately reported to YWS. Should YW incur any costs as a result of non-compliance with the above, all costs will be rechargeable in full.
16. You should ensure that nothing is done on the site to prejudice the safety or operation of YWS employees, plant or apparatus.
17. In accordance with the New Roads and Street Works Act 1991, Chapter 22, Part 3, Section 80. The location of any identified YW asset "which is not marked, or is wrongly marked, on the records made available" should be communicated back to Yorkshire Water. The location of the apparatus should be identified on copies of the supplied plans which should be returned to Yorkshire Water (Asset Records Team) with photographic supporting evidence where possible.
18. The Government has decided that responsibility for private sewers serving two or more properties and lateral drains (the section of pipe beyond the boundary of a single property, connecting it to the public sewer) will be transferred to the water companies on Oct 1 2011.











Private pumping stations will also transfer during the period 1 October 2011 – 1 Oct 2016. Records of these assets may not yet be shown on the existing mains record drawing(s). If you encounter any of these assets you must inform Yorkshire Water Services Ltd (YWS).

19. Please note that the information supplied on the enclosed plans is reproduced from Ordnance Survey material with the permission of the Ordnance Survey on behalf of the Controller of Her Majesty's Stationery Office, © Crown Copyright. Unauthorised reproduction infringes Crown Copyright and may lead to prosecution or civil proceedings. Licence Number 1000019559.
20. This information is for guidance only and the position and depth of any YW apparatus is approximate only. Likewise, the nature and condition of any YW apparatus cannot be guaranteed. YW has no responsibility for recording the locations of privately owned apparatus. As of 1 October 2011, there may be some lateral drains and/or public sewers which are not documented on YW records but may still be present. For the avoidance of doubt, this information is not a substitute for appropriate professional and/or legal advice. YW accepts no responsibility for any inaccuracy or omissions in this information. The actual position of YW apparatus must be determined on site by excavating trial holes by hand. YW requires a minimum of two working days' written notice of the intention to excavate any trial holes before any excavation can be undertaken. If there are any queries in this respect please contact Yorkshire Water on 0845 124 24 24.

Property Identifier







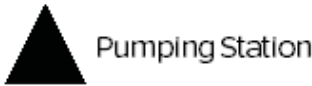

Sewer Legend

-  Combined Sewer
  S24 Combined Sewer
-  Surface Water Sewer
  S24 Surface Water Sewer
-  Foul Sewer
  S24 Foul Sewer
-  Section 104 Sewer
  Rising Main
-  Overflow Sewer
  Abandoned Sewer
-  Syphone Sewer & Vacuum Sewer



Water Legend

-  Water Main 4" and below
-  Water Main 4" and above
-  Raw Water Main
-  Private Water Main
-  Fire Hydrant
-  Pumping Station

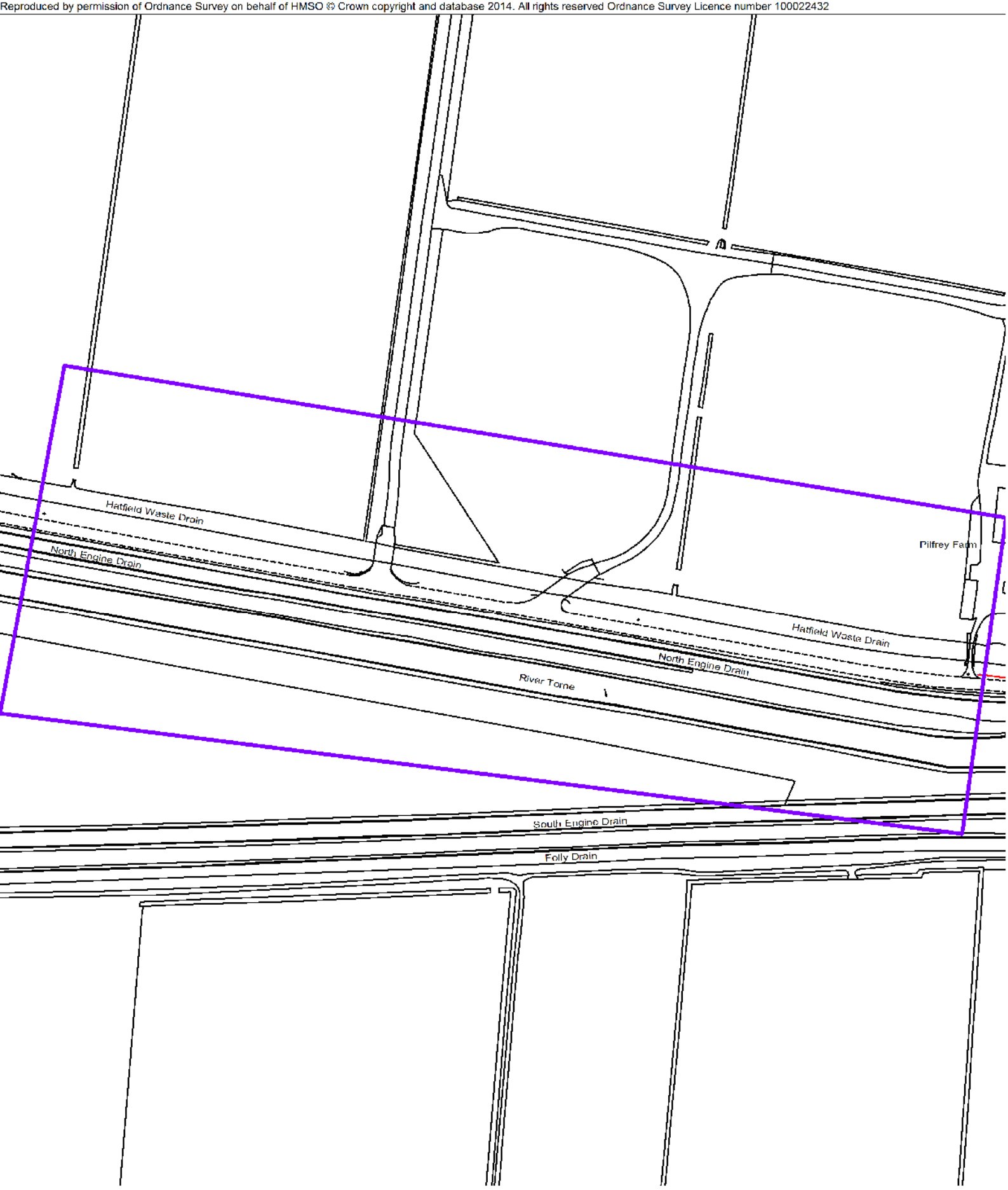

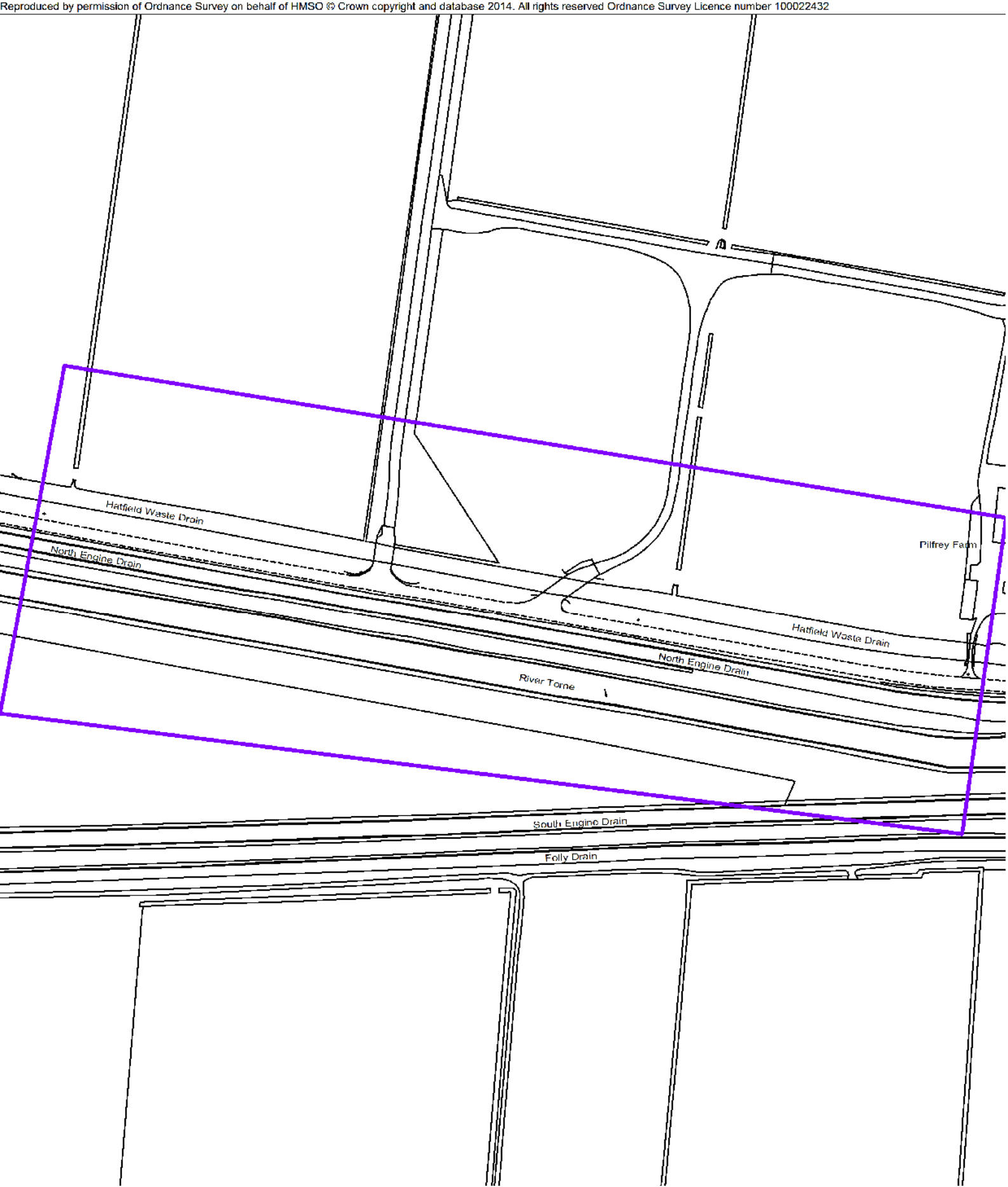

Maps by email Plant Information Reply



IMPORTANT WARNING

Information regarding the location of BT apparatus is given for your assistance and is intended for general guidance only. No guarantee is given of its accuracy. It should not be relied upon in the event of excavations or other works being made near to BT apparatus which may exist at various depths and may deviate from the marked route.



openreach

CLICK BEFORE YOU DIG

FOR PROFESSIONAL FREE ON SITE ASSISTANCE PRIOR TO COMMENCEMENT OF EXCAVATION WORKS INCLUDING LOCATE AND MARKING SERVICE

email cbyd@openreach.co.uk

ADVANCE NOTICE REQUIRED
(Office hours: Monday - Friday 08.00 to 17.00)
www.openreach.co.uk/cbyd

Accidents happen

If you do damage any Openreach equipment please let us know by calling 0800 023 2023 (opt 1 + opt 1) and we can get it fixed ASAP

KEY TO BT SYMBOLS

	Planned	Live	Change Of State	+	Hatchings	
PCP			Split Coupling	×	Built	
Pole			Duct Tee	▲	Planned	
Box			Building		Inferred	
Manhole			Kiosk		Duct	
Cabinet			Other proposed plant is shown using dashed lines. BT Symbols not listed above may be disregarded. Existing BT Plant may not be recorded. Information valid at time of preparation. Maps are only valid for 90 days after the date of publication.			
	Pending Add	In Place	Pending Remove	Not In Use		
Power Cable						
Power Duct				N/A		

Reproduced from the Ordnance Survey map by BT by permission of Ordnance Survey on behalf of the Controller of Her Majesty's Stationary Office
(C) Crown Copyright British Telecommunications plc 100028040

BT Ref : XFW07526B
Map Reference : (centre) SE8018110027
Easting/Northing : (centre) 480181,410027
Issued : 09/04/2021 07:52:59

WARNING: IF PLANNED WORKS FALL INSIDE HATCHED AREA IT IS ESSENTIAL BEFORE PROCEEDING THAT YOU CONTACT THE NATIONAL NOTICE HANDLING CENTRE. PLEASE SEND E-MAIL TO: nnhc@openreach.co.uk

Maps by email Plant Information Reply



IMPORTANT WARNING

Information regarding the location of BT apparatus is given for your assistance and is intended for general guidance only. No guarantee is given of its accuracy. It should not be relied upon in the event of excavations or other works being made near to BT apparatus which may exist at various depths and may deviate from the marked route.



openreach

CLICK BEFORE YOU DIG

FOR PROFESSIONAL FREE ON SITE ASSISTANCE PRIOR TO COMMENCEMENT OF EXCAVATION WORKS INCLUDING LOCATE AND MARKING SERVICE

email cbyd@openreach.co.uk

ADVANCE NOTICE REQUIRED
(Office hours: Monday - Friday 08.00 to 17.00)
www.openreach.co.uk/cbyd

Accidents happen

If you do damage any Openreach equipment please let us know by calling 0800 023 2023 (opt 1 + opt 1) and we can get it fixed ASAP

KEY TO BT SYMBOLS		Change Of State	+	Hatchings	
	<i>Planned</i>	<i>Live</i>	×	Built	
PCP			▲	Planned	
Pole			■	Inferred	
Box			Ⓚ	Duct	
Manhole			Other proposed plant is shown using dashed lines. BT Symbols not listed above may be disregarded. Existing BT Plant may not be recorded. Information valid at time of preparation. Maps are only valid for 90 days after the date of publication.		
Cabinet					
	<i>Pending Add</i>	<i>In Place</i>	<i>Pending Remove</i>	<i>Not In Use</i>	
Power Cable					
Power Duct				N/A	

BT Ref : OXA07531G
Map Reference : (centre) SE8047209990
Easting/Northing : (centre) 480472,409990
Issued : 09/04/2021 07:53:36

Reproduced from the Ordnance Survey map by BT by permission of Ordnance Survey on behalf of the Controller of Her Majesty's Stationary Office
(C) Crown Copyright British Telecommunications plc 100028040

WARNING: IF PLANNED WORKS FALL INSIDE HATCHED AREA IT IS ESSENTIAL BEFORE PROCEEDING THAT YOU CONTACT THE NATIONAL NOTICE HANDLING CENTRE. PLEASE SEND E-MAIL TO: nnhc@openreach.co.uk

Maps by email Plant Information Reply



IMPORTANT WARNING

Information regarding the location of BT apparatus is given for your assistance and is intended for general guidance only. No guarantee is given of its accuracy. It should not be relied upon in the event of excavations or other works being made near to BT apparatus which may exist at various depths and may deviate from the marked route.



openreach

CLICK BEFORE YOU DIG

FOR PROFESSIONAL FREE ON SITE ASSISTANCE PRIOR TO COMMENCEMENT OF EXCAVATION WORKS INCLUDING LOCATE AND MARKING SERVICE

email cbyd@openreach.co.uk

ADVANCE NOTICE REQUIRED
(Office hours: Monday - Friday 08.00 to 17.00)
www.openreach.co.uk/cbyd

Accidents happen

If you do damage any Openreach equipment please let us know by calling 0800 023 2023 (opt 1 + opt 1) and we can get it fixed ASAP

KEY TO BT SYMBOLS

	Planned	Live	Change Of State	+	Hatchings	
PCP			Split Coupling	×	Built	
Pole			Duct Tee	▲	Planned	
Box			Building		Inferred	
Manhole			Kiosk		Duct	
Cabinet			Other proposed plant is shown using dashed lines. BT Symbols not listed above may be disregarded. Existing BT Plant may not be recorded. Information valid at time of preparation. Maps are only valid for 90 days after the date of publication.			
	Pending Add	In Place	Pending Remove	Not In Use		
Power Cable						
Power Duct				N/A		

Reproduced from the Ordnance Survey map by BT by permission of Ordnance Survey on behalf of the Controller of Her Majesty's Stationary Office
(C) Crown Copyright British Telecommunications plc 100028040

BT Ref : SDB07538P
Map Reference : (centre) SE8072309961
Easting/Northing : (centre) 480723,409961
Issued : 09/04/2021 07:53:49

WARNING: IF PLANNED WORKS FALL INSIDE HATCHED AREA IT IS ESSENTIAL BEFORE PROCEEDING THAT YOU CONTACT THE NATIONAL NOTICE HANDLING CENTRE. PLEASE SEND E-MAIL TO: nnhc@openreach.co.uk

Enquirer			
Name	Mr Keith Smith	Phone	01952686572
Company	Apogee	Mobile	07811923927
Address	Blount House Hall Court Hall Park Way Telford Shropshire TF3 4NQ		
Email	keith.smith@apogeeutilityconsultants.co.uk		

Enquiry Details			
Scheme/Reference	422015		
Enquiry type	Initial Enquiry	Work category	Utility Works
Start date	09/04/2021	Work type	Single excavation site
End date	10/05/2021	Site size	132393 metres square
Searched location	DN17 4DA	Work type buffer*	25 metres
Confirmed location	480411 409999		
Site Contact Name	Not Supplied	Site Phone No	Not Supplied
Description of Works			

* The WORK TYPE BUFFER is a distance added to your search area based on the Work type you have chosen.

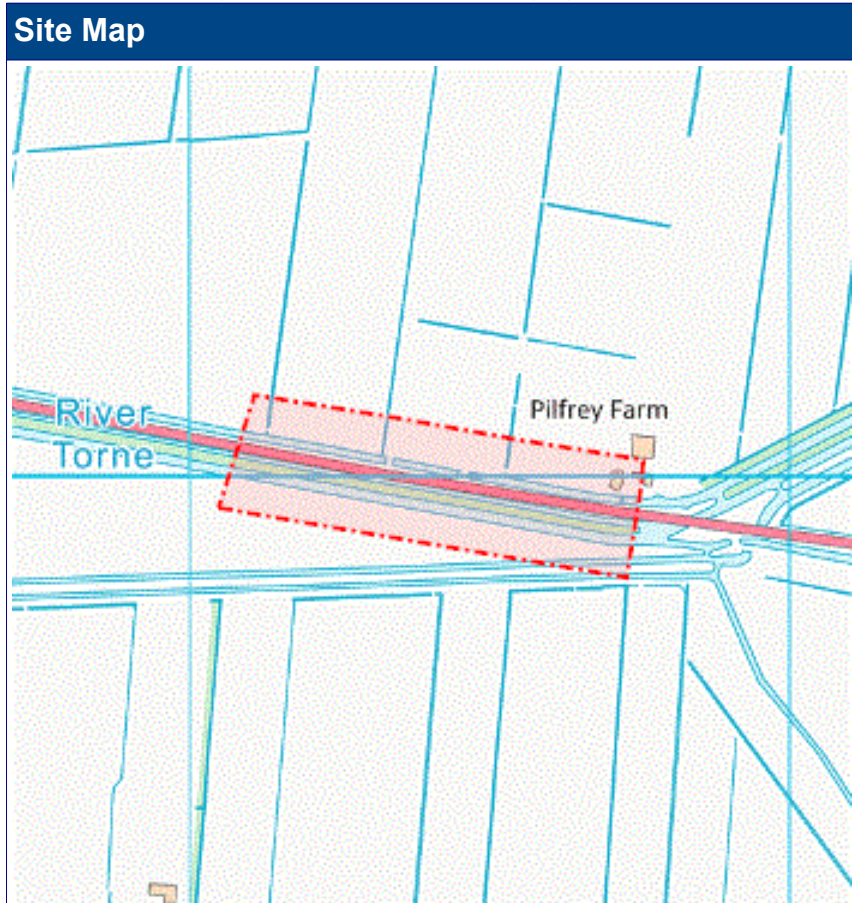

Asset Owners

Terms and Conditions. Please note that this enquiry is subject always to our standard terms and conditions available at www.linesearchbeforeudig.co.uk ("Terms of Use") and the disclaimer at the end of this document. Please note that in the event of any conflict or ambiguity between the terms of this Enquiry Confirmation and the Terms of Use, the Terms of Use shall take precedence.

Notes. Please ensure your contact details are correct and up to date on the system in case the LSBUD Members need to contact you.

Validity and search criteria. The results of this enquiry are based on the confirmed information you entered and are valid only as at the date of the enquiry. It is your responsibility to ensure that the Enquiry Details are correct, and LineSearchbeforeUdig accepts no responsibility for any errors or omissions in the Enquiry Details or any consequences thereof. LSBUD Members update their asset information on a regular basis so you are advised to consider this when undertaking any works. It is your responsibility to choose the period of time after which you need to resubmit any enquiry but the maximum time (after which your enquiry will no longer be dealt with by the LSBUD Helpdesk and LSBUD Members) is 28 days. If any details of the enquiry change, particularly including, but not limited to, the location of the work, then a further enquiry must be made.

Asset Owners & Responses. Please note the enquiry results include the following:

1. "LSBUD Members" who are asset owners who have registered their assets on the LSBUD service.
2. "Non LSBUD Members" are asset owners who have not registered their assets on the LSBUD service but LSBUD is aware of their existence. Please note that there could be other asset owners within your search area.

Below are three lists of asset owners:

1. **LSBUD Members who have assets registered within your search area. ("Affected")**
 - a. These LSBUD Members will either:
 - i. Ask for further information ("Email Additional Info" noted in status). The additional information includes: Site contact name and number, Location plan, Detailed plan (minimum scale 1:2500), Cross sectional drawings (if available), Work Specification.
 - ii. Respond directly to you ("Await Response"). In this response they may either send plans directly to you or ask for further information before being able to do so, particularly if any payments or authorisations are required.
2. **LSBUD Members who do not have assets registered within your search area. ("Not Affected")**
3. **Non LSBUD Members who may have assets within your search area.** Please note that this list is not exhaustive and all details are provided as a guide only. It is your responsibility to identify and consult with all asset owners before proceeding.

National Grid. Please note that the LSBUD service only contains information on National Grid's Gas above 7 bar asset, all National Grid Electricity Transmission assets and National Grid's Gas Distribution Limited above 2 bar asset.

For National Grid Gas Distribution Ltd below 2 bar asset information please go to www.beforeyoudig.nationalgrid.com

LSBUD Members who have assets registered on the LSBUD service within the vicinity of your search area.

List of affected LSBUD members

Asset Owner	Phone/Email	Emergency Only	Status
National Grid Gas (Above 7 bar), National Grid Gas Distribution Limited (Above 2 bar) and National Grid Electricity Transmission	0800688588 plantprotection@cadentgas.com	Gas 0800111999 Electricity 0800404090	Email Additional Info

LSBUD Members who do not have assets registered on the LSBUD service within the vicinity of your search area. Please be aware that LSBUD Members make regular changes to their assets and this list may vary for new enquiries in the same area.

List of not affected LSBUD members

AWE Pipeline	Balfour Beatty Investments Limited	BOC Limited (A Member of the Linde Group)
Box Broadband	BP Exploration Operating Company Limited	BPA
Carrington Gas Pipeline	CATS Pipeline c/o Wood Group PSN	Cemex
Centrica Storage Ltd	Chrysaor Production (UK) Limited	CLH Pipeline System Ltd
CNG Services Ltd	Concept Solutions People Ltd	ConocoPhillips (UK) Teesside Operator Ltd
Diamond Transmission Corporation	DIO (MOD Abandoned Pipelines)	DIO (MOD Live Pipelines)
E.ON UK CHP Limited	EirGrid	Electricity North West Limited
ENI & Himor c/o Penspen Ltd	EnQuest NNS Limited	EP Langage Limited
ESP Utilities Group	ESSAR	Esso Petroleum Company Limited
Fulcrum Pipelines Limited	Gamma	Gas Networks Ireland (UK)
Gateshead Energy Company	Gigaclear Ltd	Gtt
Heathrow Airport LTD	Humbly Grove Energy	IGas Energy
INEOS FPS Pipelines	INEOS Manufacturing (Scotland and TSEP)	INOVYN ChlorVinyls Limited
INOVYN Enterprises Limited	Intergen (Coryton Energy or Spalding Energy)	Jurassic Fibre Ltd
Mainline Pipelines Limited	Manchester Jetline Limited	Manx Cable Company
Marchwood Power Ltd (Gas Pipeline)	Melbourn Solar Limited	Murphy Utility Assets
Northumbrian Water Group	NPower CHP Pipelines	NYnet Ltd
Oikos Storage Limited	Ørsted	Perenco UK Limited (Purbeck Southampton Pipeline)
Petroineos	Phillips 66	Portsmouth Water
Premier Transmission Ltd (SNIP)	Redundant Pipelines - LPDA	RWE - Great Yarmouth Pipeline (Bacton to Great Yarmouth Power Station)
RWEnpower (Little Barford and South Haven)	SABIC UK Petrochemicals	Scottish and Southern Electricity Networks
Scottish Power Generation	Seabank Power Ltd	SES Water
SGN	Shell	Shell NOP
SSE Enterprise Telecoms	SSE Generation Ltd	SSE Utility Solutions Limited
Tata Communications (c/o JSM Construction Ltd)	Total (Colnbrook & Colwick Pipelines)	Total Finaline Pipelines
Transmission Capital	UK Power Networks	Uniper UK Ltd
University of Cambridge Granta Backbone	Vattenfall	Veolia ES SELCHP Limited

Network

Veolia ES Sheffield Ltd

VPI Power Limited

Wales and West Utilities

West of Duddon Sands Transmission Ltd

Western Power Distribution

Westminster City Council

Zayo Group UK Ltd c/o JSM Group Ltd

From: assetrecords@utilityassets.co.uk
To: [Keith Smith](#)
Subject: Re: URGENT C2 ENQUIRY REQUEST 422015 Chesswick Crescent
Date: 22 March 2021 09:56:31

Thank you for recently contacting Utility Assets plant record department. We will check whether we have any plant present at your site and contact you within 5 - 7 working days ONLY if we own any plant in the vicinity.

If we do not reply, we do not have any apparatus in the area of your works. However, PLEASE TAKE CARE when excavating around electricity cables in the event that not all cables present may be accurately shown. We recommend you use detecting equipment to map the site before excavating and fully comply with HSG47. DO NOT assume that a cable is dead if you don't have a record of its presence. The cable must be treated as live unless PROVEN DEAD by the cable owner. In case of emergency please contact your local electricity distribution company.

This is an automated reply from our dedicated asset records email address. If you receive further correspondence from us it will be from asset.manager@utilityassets.co.uk quoting a site reference number.

Asset Manager - Utility Assets Ltd

From: plantenquiryservice@gtc-uk.co.uk
To: [Keith Smith](#)
Subject: GTC Plant Enquiry - Ref- 1763503
Date: 22 March 2021 10:15:50
Attachments: [1763503.png](#)

GTC Apparatus Not Found In Search Area

Our Plant Enquiry Service Ref: 1763503
Your Enquiry Ref: 422015

Dear keith,

Thank you for your enquiry concerning apparatus in the vicinity of your proposed work. GTC can confirm that we have no apparatus in the vicinity but please note that other asset owners may have and ensure all utility owners have been consulted. For your records, the search area is shown in the attached map.

Please note our assets now include those owned and operated by:

- GTC Pipelines Limited
- Independent Pipelines Limited
- Quadrant Pipelines Limited
- Electricity Network Company Limited
- Independent Power Networks Limited
- Independent Water Networks Limited
- Open Fibre Networks Limited
- Independent Community Heating Limited

If you have any queries or require any further information please do not hesitate to contact us.

Your sincerely,

GTC Plant Enquiry Service.

GTC
Synergy House
Woolpit Business Park
Woolpit
Bury St Edmunds
Suffolk, IP30 9UP
Tel: 01359 240363
plant.enquiries@gtc-uk.co.uk

NOTE:

This E-Mail originates from GTC, Synergy House, Woolpit Business Park, Woolpit, Bury St Edmunds, Suffolk, IP30 9UP
VAT Number: GB688 8971 40. Registered No: 029431.

DISCLAIMER

The information in this E-Mail and in any attachments is confidential and may be privileged. If you are

From: [Plant Enquiries](#)
To: [Keith Smith](#)
Subject: RE: URGENT C2 ENQUIRY REQUEST 422015 Chesswick Crescent
Date: 22 March 2021 10:38:35
Attachments: [image001.png](#)
[image298169.png](#)
[image463465.png](#)
[image569077.png](#)
[image999388.png](#)

Dear Sir/Madam,

Thank you for submitting your recent plant enquiry.

Based on the information provided, I can confirm that Last Mile **does not** have any plant within the area(s) specified in your request.

If you require further assistance with outstanding enquiries, please call 03300 587 443.

Please ensure all plant enquiries are sent to plantenquiries@lastmile-uk.com

Regards



Plant Enquiries

e: plantenquiries@lastmile-uk.com | w: www.energetics-uk.com

a: Fenick House, Lister Way, Hamilton International Technology Park, Glasgow, G72 0FT



From: Keith Smith <keith.smith@apogeeutilityconsultants.co.uk>
Sent: 22 March 2021 09:56
To: Plant Enquiries <plantenquiries@lastmile-uk.com>
Subject: URGENT C2 ENQUIRY REQUEST 422015 Chesswick Crescent

Dear Sir or Madam,

ROADS AND STREET WORKS ACT 1991 PRELIMINARY ENQUIRY Appendix C2 of the Code of Practice (CoP) 'Measures Necessary Where Apparatus Is Affected By Major Works (Diversionary Works)'
My client is considering a scheme involving major highway works as detailed below:

Scheme Number: 422015
Location of Works: Chesswick Crescent
Postcode: DN17 4DA
O.S. Grid Ref.: 480411 , 409999
Road Name: A18
From: A18
To: A18
Description of Works: Utility Work
Expected Start Date: 30th March 2021

Plans showing the area for the works are attached

In order that all reasonable precautions may be taken to avoid risk to health and safety through contact with any of your existing apparatus during execution of the proposed works, please indicate the position and depth of your apparatus in the locality of the proposed works and return the plan to this office.

Notice under The Street Works (Registers, Notices, Directions and Designations) Regulations will be sent to all Undertakers as appropriate.

Unless you notify us within 10 days setting out when you will be able to reply, it will be assumed that you are able to comply with the provision of Table 1 of Appendix C (i.e. that the information requested will be provided within 10 working days).

Should you require any further information, please contact us immediately

Yours sincerely,

Keith Smith

Keith Smith
Site & Services Manager



Blount House
Hall Court
Hall Park Way

From: ricky.rowe@engie.com
To: [Jeremy Haigh](#)
Subject: RE: Postcode Confirmations
Date: 28 January 2020 11:51:28
Attachments: [image006.png](#)

1) Location of ENGIE's Apparatus

ENGIE has buried pipework either inside or very close to the area codes listed below:

- Birmingham – B1-B9, B15-B19
- Coventry – CV1, CV2, CV3
- Eastleigh – SO50
- Hatfield – Comet Square - AL10
- Leicester – LE1-LE5
- London
 - Bloomsbury - W1 (all sub codes), WC1 (all sub codes), WC2 (all sub codes), NW1, N1C
 - Olympic Site - E3, E7, E9, E10, E11, E13, E15, E20
 - Whitehall - SW1A, SW1E, SW1H, SW1P, SW1V, SW1Y
 - ExCel Exhibition Centre - E16
 - Embassy Quarter – SW8, SW11
- Southampton – SO14, SO15, SO17
- Leeds – LS2
- Newcastle – TBC
- Edinburgh – TBC

If the location of the request for information falls within the vicinity of any of these area codes then the location they specify should be looked into in greater detail and compared with the as-built drawings of ENGIE's network. If the location is not in the vicinity of any of these cities a negative response can immediately be returned.

Also note that ENGIE oversee the operation of the CHP engines at the below sites. Whilst there is buried network at these sites, ENGIE are not responsible for their operation and maintenance. These are mentioned purely for completion of records.

- Pimlico
- Royal Borough of Kensington & Chelsea

Kind regards

Ricky Rowe
Document Controller
Urban Energy
UK & Ireland

Kings Yard
5 Clarnico Lane
Queen Elizabeth Park
London E15 2HG

ricky.rowe@engie.com
Tel. +44 (0) 208 221 6530
Mob. +44 (0) 7814 773944

-
ENGIE



engie.co.uk



Ordnance Survey © Crown Copyright, 100018507

There are no assets within this map area



Ordnance Survey © Crown Copyright, 100018507

There are no assets within this map area



Ordnance Survey © Crown Copyright, 100018507

There are no assets within this map area



Ordnance Survey © Crown Copyright, 100018507

There are no assets within this map area



Ordnance Survey © Crown Copyright, 100018507

There are no assets within this map area



Ordnance Survey © Crown Copyright, 100018507

There are no assets within this map area



Ordnance Survey © Crown Copyright, 100018507

There are no assets within this map area



Ordnance Survey © Crown Copyright, 100018507

There are no assets within this map area



Ordnance Survey © Crown Copyright, 100018507

There are no assets within this map area



Ordnance Survey © Crown Copyright, 100018507

There are no assets within this map area



Ordnance Survey © Crown Copyright, 100018507

There are no assets within this map area



Ordnance Survey © Crown Copyright, 100018507

There are no assets within this map area



Ordnance Survey © Crown Copyright, 100018507

There are no assets within this map area



Ordnance Survey © Crown Copyright, 100018507

There are no assets within this map area



Ordnance Survey © Crown Copyright, 100018507

There are no assets within this map area



Ordnance Survey © Crown Copyright, 100018507

There are no assets within this map area



Ordnance Survey © Crown Copyright, 100018507

There are no assets within this map area



Ordnance Survey © Crown Copyright, 100018507

There are no assets within this map area



Ordnance Survey © Crown Copyright, 100018507

There are no assets within this map area



Ordnance Survey © Crown Copyright, 100018507

There are no assets within this map area



Ordnance Survey © Crown Copyright, 100018507

There are no assets within this map area



Ordnance Survey © Crown Copyright, 100018507

There are no assets within this map area



Ordnance Survey © Crown Copyright, 100018507

There are no assets within this map area



Ordnance Survey © Crown Copyright, 100018507

There are no assets within this map area



Ordnance Survey © Crown Copyright, 100018507

There are no assets within this map area



Ordnance Survey © Crown Copyright, 100018507

There are no assets within this map area



Ordnance Survey © Crown Copyright, 100018507

There are no assets within this map area



Ordnance Survey © Crown Copyright, 100018507

There are no assets within this map area



Ordnance Survey © Crown Copyright, 100018507

There are no assets within this map area



Ordnance Survey © Crown Copyright, 100018507

There are no assets within this map area



Ordnance Survey © Crown Copyright, 100018507

There are no assets within this map area



Ordnance Survey © Crown Copyright, 100018507

There are no assets within this map area



Ordnance Survey © Crown Copyright, 100018507

There are no assets within this map area



Ordnance Survey © Crown Copyright, 100018507

There are no assets within this map area



Ordnance Survey © Crown Copyright, 100018507

There are no assets within this map area



Ordnance Survey © Crown Copyright, 100018507

There are no assets within this map area



Ordnance Survey © Crown Copyright, 100018507

There are no assets within this map area



Ordnance Survey © Crown Copyright, 100018507

There are no assets within this map area



Ordnance Survey © Crown Copyright, 100018507

There are no assets within this map area



Ordnance Survey © Crown Copyright, 100018507

There are no assets within this map area



Ordnance Survey © Crown Copyright, 100018507

There are no assets within this map area



Ordnance Survey © Crown Copyright, 100018507

There are no assets within this map area



Piffrey Farm

Do not scale off this Map. This plan and any information supplied with it is furnished as a general guide, is only valid at the date of issue and no warranty as to its correctness is given or implied. In particular this plan and any information shown on it must not be relied upon in the event of any development or works (including but not limited to excavations) in the vicinity of SEVERN TRENT WATER assets or for the purposes of determining the suitability of a point of connection to the sewerage or distribution systems. On 1 October 2011 most private sewers and private lateral drains in Severn Trent Water's sewerage area, which were connected to a public sewer as at 1 July 2011, transferred to the ownership of Severn Trent Water and became public sewers and public lateral drains. A further transfer takes place on 1 October 2012. Private pumping stations, which form part of these sewers or lateral drains, will transfer to ownership of Severn Trent Water on or before 1 October 2016. Severn Trent Water does not possess complete records of these assets. These assets may not be displayed on the map. Reproduction by permission of Ordnance Survey on behalf of HMSO. © Crown Copyright and database right 2021. All rights reserved. Ordnance Survey licence number: 100031673. Document users other than SEVERN TRENT WATER business users are advised that this document is provided for reference purpose only and is subject to copyright, therefore, no further copies should be made from it.

Public Sewer	Public Sewer	Public Sewer	Public Sewer	Public Sewer	Public Sewer
Private Sewer	Private Sewer	Private Sewer	Private Sewer	Private Sewer	Private Sewer
Manhole	Manhole	Manhole	Manhole	Manhole	Manhole
Access Point	Access Point	Access Point	Access Point	Access Point	Access Point
Other	Other	Other	Other	Other	Other

keith.smith@apogeeutilityconsultants.co.uk

422015



GENERAL CONDITIONS AND PRECAUTIONS TO BE TAKEN WHEN CARRYING OUT WORK ADJACENT TO SEVERN TRENT WATER'S APPARATUS

Please ensure that a copy of these conditions is passed to your representative and/or your contractor on site. If any damage is caused to Severn Trent Water Limited (STW) apparatus (defined below), the person, contractor or subcontractor responsible must inform STW immediately on: **0800 783 4444 (24 hours)**

- a) These general conditions and precautions apply to the public sewerage, water distribution and cables in ducts including (but not limited to) sewers which are the subject of an Agreement under Section 104 of the Water Industry Act 1991(a legal agreement between a developer and STW, where a developer agrees to build sewers to an agreed standard, which STW will then adopt); mains installed in accordance with an agreement for the self-construction of water mains entered into with STW and the assets described at condition b) of these general conditions and precautions. Such apparatus is referred to as "STW Apparatus" in these general conditions and precautions.
- b) Please be aware that due to The Private Sewers Transfer Regulations June 2011, the number of public sewers has increased, but many of these are not shown on the public sewer record. However, some idea of their positions may be obtained from the position of inspection covers and their existence must be anticipated.
- c) On request, STW will issue a copy of the plan showing the approximate locations of STW Apparatus although in certain instances a charge will be made. The position of private drains, private sewers and water service pipes to properties are not normally shown but their presence must be anticipated. This plan and the information supplied with it is furnished as a general guide only and STW does not guarantee its accuracy.
- d) STW does not update these plans on a regular basis. Therefore the position and depth of STW Apparatus may change and this plan is issued subject to any such change. Before any works are carried out, you should confirm whether any changes to the plan have been made since it was issued.
- e) The plan must not be relied upon in the event of excavations or other works in the vicinity of STW Apparatus. It is your responsibility to ascertain the precise location of any STW Apparatus prior to undertaking any development or other works (including but not limited to excavations).
- f) No person or company shall be relieved from liability for loss and/or damage caused to STW Apparatus by reason of the actual position and/or depths of STW Apparatus being different from those shown on the plan.

In order to achieve safe working conditions adjacent to any STW Apparatus the following should be observed:

1. All STW Apparatus should be located by hand digging prior to the use of mechanical excavators.
2. All information set out in any plans received from us, or given by our staff at the site of the works, about the position and depth of the mains, is approximate. Every possible precaution should be taken to avoid damage to STW Apparatus. You or your contractor must ensure the safety of STW Apparatus and will be responsible for the cost of repairing any loss and/or damage caused (including without limitation replacement parts).
3. Water mains are normally laid at a depth of 900mm. No records are kept of customer service pipes which are normally laid at a depth of 750mm; but some idea of their positions may be obtained from the position of stop tap covers and their existence must be anticipated.
4. During construction work, where heavy plant will cross the line of STW Apparatus, specific crossing points must be agreed with STW and suitably reinforced where required. These crossing points should be clearly marked and crossing of the line of STW Apparatus at other locations must be prevented.
5. Where it is proposed to carry out piling or boring within 20 metres of any STW Apparatus, STW should be consulted to enable any affected STW Apparatus to be surveyed prior to the works commencing.
6. Where excavation of trenches adjacent to any STW Apparatus affects its support, the STW Apparatus must be supported to the satisfaction of STW. Water mains and some sewers are pressurised and can fail if excavation removes support to thrust blocks to bends and other fittings.
7. Where a trench is excavated crossing or parallel to the line of any STW Apparatus, the backfill should be adequately compacted to prevent any settlement which could subsequently cause damage to the STW Apparatus. In special cases, it may be necessary to provide permanent support to STW Apparatus which has been exposed over a length of the excavation before backfilling and reinstatement is carried out. There should be no concrete backfill in contact with the STW Apparatus.
8. No other apparatus should be laid along the line of STW Apparatus irrespective of clearance. Above ground apparatus must not be located within a minimum of 3 metres either side of the centre line of STW Apparatus for smaller sized pipes and 6 metres either side for larger sized pipes without prior approval. No manhole or chamber shall be built over or around any STW Apparatus.
9. A minimum radial clearance of 300 millimetres should be allowed between any plant or equipment being installed and existing STW Apparatus. We reserve the right to increase this distance where strategic assets are affected.
10. Where any STW Apparatus coated with a special wrapping is damaged, even to a minor extent, STW must be notified and the trench left open until the damage has been inspected and the necessary repairs have been carried out. In the case of any material damage to any STW Apparatus causing leakage, weakening of the mechanical strength of the pipe or corrosion-protection damage, the necessary remedial work will be recharged to you.
11. It may be necessary to adjust the finished level of any surface boxes which may fall within your proposed construction. Please ensure that these are not damaged, buried or otherwise rendered inaccessible as a result of the works and that all stop taps, valves, hydrants, etc. remain accessible and operable. Minor reduction in existing levels may result in conflict with STW Apparatus such as valve spindles or tops of hydrants housed under the surface boxes. Checks should be made during site investigations to ascertain the level of such STW Apparatus in order to determine any necessary alterations in advance of the works.
12. With regard to any proposed resurfacing works, you are required to contact STW on the number given above to arrange a site inspection to establish the condition of any STW Apparatus in the nature of surface boxes or manhole covers and frames affected by the works. STW will then advise on any measures to be taken, in the event of this a proportionate charge will be made.
13. You are advised that STW will not agree to either the erection of posts, directly over or within 1.0 metre of valves and hydrants,
14. No explosives are to be used in the vicinity of any STW Apparatus without prior consultation with STW.

TREE PLANTING RESTRICTIONS

There are many problems with the location of trees adjacent to sewers, water mains and other STW Apparatus and these can lead to the loss of trees and hence amenity to the area which many people may have become used to. It is best if the problem is not created in the first place. Set out below are the recommendations for tree planting in close proximity to public sewers, water mains and other STW Apparatus.

15. Please ensure that, in relation to STW Apparatus, the mature root systems and canopies of any tree planted do not and will not encroach within the recommended distances specified in the notes below.
16. Both Poplar and Willow trees have extensive root systems and should not be planted within 12 metres of a sewer, water main or other STW Apparatus.
17. The following trees and those of similar size, be they deciduous or evergreen, should not be planted within 6 metres of a sewer, water main or other STW Apparatus. E.g. Ash, Beech, Birch, most Conifers, Elm, Horse Chestnut, Lime, Oak, Sycamore, Apple and Pear. Asset Protection Statements Updated May 2014
18. STW personnel require a clear path to conduct surveys etc. No shrubs or bushes should be planted within 2 metre of the centre line of a sewer, water main or other STW Apparatus.
19. In certain circumstances, both STW and landowners may wish to plant shrubs/bushes in close proximity to a sewer, water main of other STW Apparatus for screening purposes. The following are shallow rooting and are suitable for this purpose: Blackthorn, Broom, Cotoneaster, Elder, Hazel, Laurel, Privet, Quickthorn, Snowberry, and most ornamental flowering shrubs.

From: [Joi, Ravina](#)
To: [Keith Smith](#)
Subject: RE: URGENT C2 ENQUIRY REQUEST 422015 Chesswick Crescent
Date: 23 March 2021 08:28:13
Attachments: [image001.png](#)
[image002.png](#)

Please accept this email as confirmation that Vodafone: Fixed **does not** have apparatus within the vicinity of your proposed works detailed below.

Many thanks.

Plant Enquiries Team
T: +44 (0)1454 662881
E: osm.enquiries@atkinsglobal.com

This response is made only in respect to electronic communications apparatus forming part of the Vodafone Limited electronic communications network formerly being part of the electronic communications networks of Cable & Wireless UK (now re-named Vodafone Enterprise UK), Energis Communications Limited, Thus Group Holdings Limited and Your Communications Limited.

ATKINS working on behalf of Vodafone: Fixed



PLEASE NOTE:

The information given is indicative only. No warranty is made as to its accuracy. This information must not be solely relied upon in the event of excavation or other works carried out in the vicinity of Vodafone plant. No liability of any kind whatsoever is accepted by Vodafone, its servants, or agents, for any error or omission in respect of information contained on this information. The actual position of underground services must be verified and established on site before any mechanical plant is used. Authorities and contractors will be held liable for the full cost of repairs to Vodafone's apparatus and all claims made against them by Third parties as a result of any interference or damage.

IMPORTANT - PLEASE READ:

Diversions may be necessary if the existing line of the highway/railway or its levels are altered, where apparatus is affected. Where apparatus is affected and requires diversion, you must submit draft details of the proposed scheme with a request for a 'C3 Budget Estimate' to c3requests@vodafone.com. These estimates should be provided by Vodafone normally within 20 working days from receipt of your request. Please include proof of this C2 response when requesting a C3 (using the 'forward' option).



Please consider the environment before printing this e-mail

From: Keith Smith <keith.smith@apogeeutilityconsultants.co.uk>
Sent: 22 March 2021 15:27
To: National Plant Enquiries <OSM.enquiries@atkinsglobal.com>
Subject: URGENT C2 ENQUIRY REQUEST 422015 Chesswick Crescent

Dear Sir or Madam,

ROADS AND STREET WORKS ACT 1991 PRELIMINARY ENQUIRY Appendix C2 of the Code of Practice (CoP) 'Measures Necessary Where Apparatus Is Affected By Major Works (Diversions Works)'

My client is considering a scheme involving major highway works as detailed below:

Scheme Number: 422015
Location of Works: Chesswick Crescent
Postcode: DN17 4DA



(c) Crown copyright and database rights 2021 Ordnance Survey 100019209 Date: 22/03/21 Scale: 1:1250 Map Centre: 480516.409998 Data updated: 05/02/21 Our Ref: 525745 - 1 Telecoms Plan A1

Important information - please read the purpose of this plan is to identify Virgin Media apparatus. We have tried to make it as accurate as possible but we cannot warrant its accuracy. In addition, we caution that within Virgin Media apparatus there may be instances where mains voltage power cables have been placed inside green, rather than black ducting. Further details can be found using the 'Affected Postcodes.pdf' which can be downloaded from this website. Therefore, you must not rely solely on this plan if you are carrying out any excavation or other works in the vicinity of Virgin Media apparatus. The actual position of any underground service must be verified by cable detection equipment, etc. and established on site before any mechanical plant is used. Accordingly, unless it is due to the negligence of Virgin Media, its employees or agents, Virgin Media will not have any liability for any omissions or inaccuracies in the plan or for any loss or damage caused or arising from the use of and/or any reliance on this plan. This plan is produced by Virgin Media Limited (c) Crown copyright and database rights 2021 Ordnance Survey 100019209.

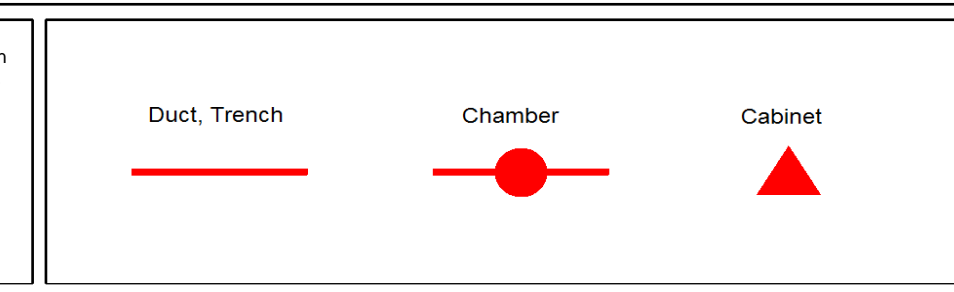

jeremy.haigh@apogeepropertyandutilityconsultants.com
422015

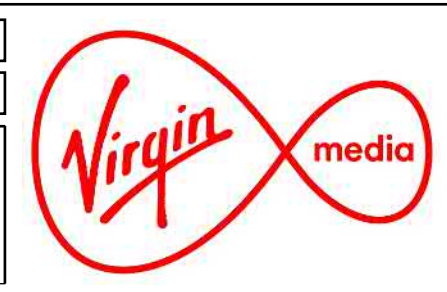

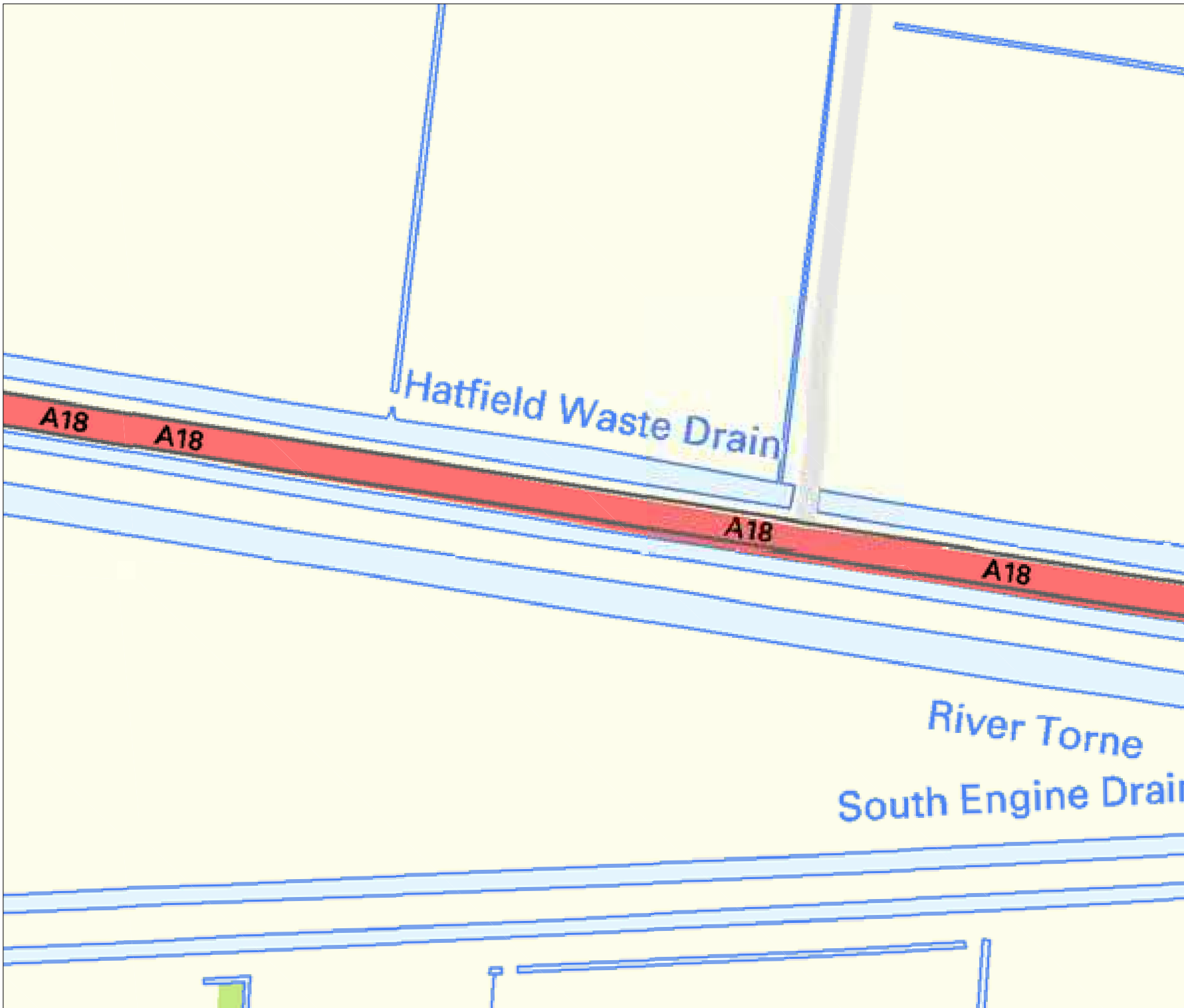

bitmap_layout select_raster

LEGEND

- EXISTING PLANT
- EXISTING PLANT

bitmap_layout select_raster

Head Office
CityFibre Holdings Ltd
15 Bedford Street,
London,
WC2E 9HE

Tel: 0845 293 0774
Web: www.cityfibre.com

Asset Office
CityFibre Holdings Ltd,
Rutherford House,
Birchwood,
Warrington,
WA3 6ZH

Email: asset.team@cityfibre.com

Disclaimer:

Information shown on this plan is for general guidance only. No warranty is made as to its accuracy. This plan must not be solely relied upon in the event of excavation or other works being carried out in the vicinity of Cityfibre plant. No liability of any kind is accepted by Cityfibre, its agents or servants for any error, omission, discrepancy or deviation. This information is valid for the date printed.

Project

Plant Enquiry

Drawing

Existing Plant

Drawn by:

smallworld

Date: 09/04/2021

Drawing No.

CFH_EP_000001

Revision

001

Scale: 1:2500

A4

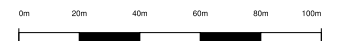

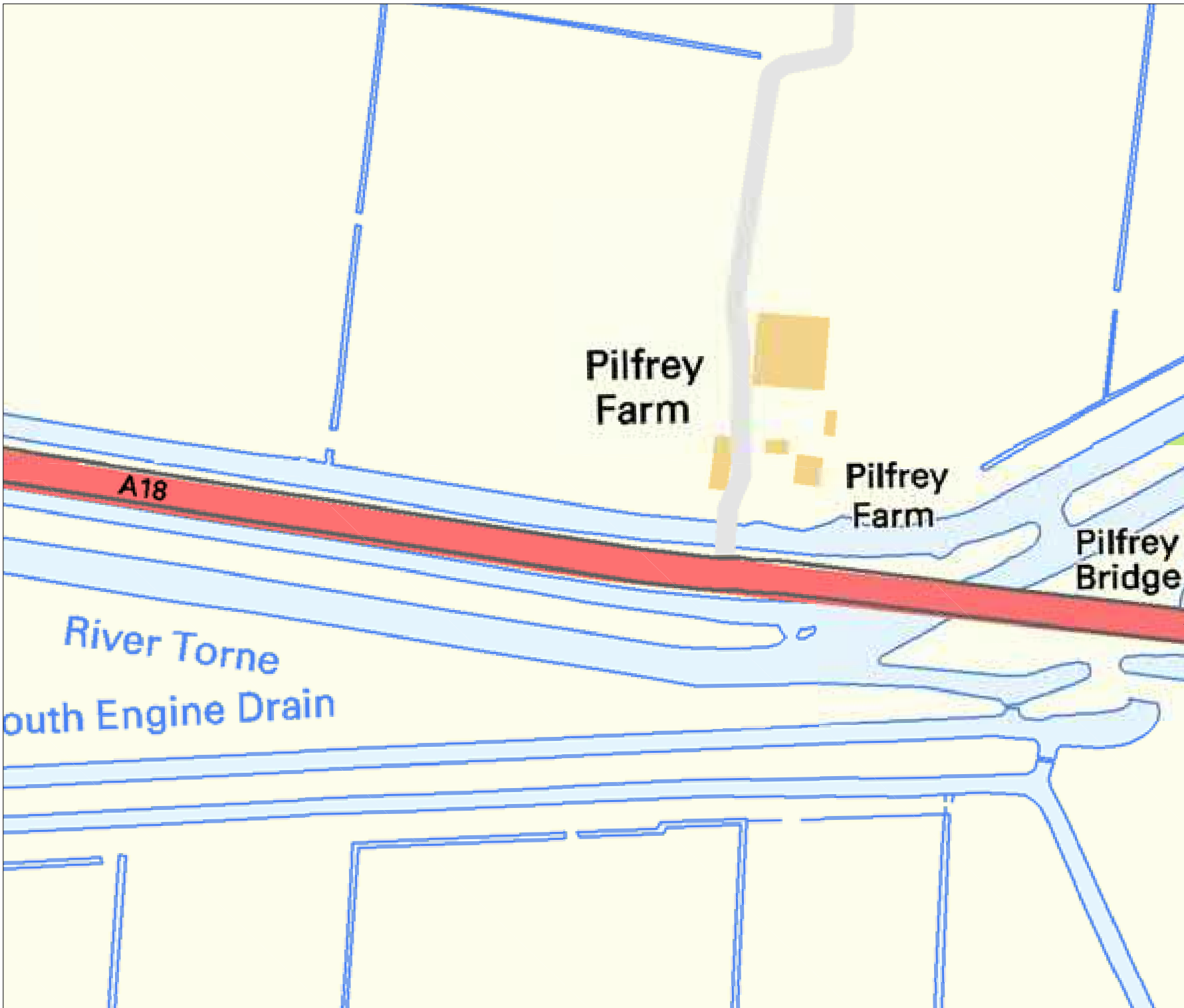

bitmap_layout select_raster

LEGEND

- EXISTING PLANT
- EXISTING PLANT

bitmap_layout select_raster

Head Office
CityFibre Holdings Ltd
15 Bedford Street,
London,
WC2E 9HE
Tel: 0845 293 0774
Web: www.cityfibre.com

Asset Office
CityFibre Holdings Ltd,
Rutherford House,
Birchwood,
Warrington,
WA3 6ZH
Email: asset.team@cityfibre.com

Disclaimer:

Information shown on this plan is for general guidance only. No warranty is made as to its accuracy. This plan must not be solely relied upon in the event of excavation or other works being carried out in the vicinity of Cityfibre plant. No liability of any kind is accepted by Cityfibre, its agents or servants for any error, omission, discrepancy or deviation. This information is valid for the date printed.

Project

Plant Enquiry

Drawing

Existing Plant

Drawn by:

smallworld

Date: 09/04/2021

Drawing No.

CFH_EP_000001

Revision

001

Scale: 1:2500

A4

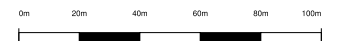

From: [Plantenquiries](#)
To: [Keith Smith](#)
Subject: RE: URGENT C2 ENQUIRY REQUEST 422015 Chesswick Crescent
Date: 25 March 2021 19:23:08
Attachments: [image001.png](#)
[image003.png](#)
[image004.png](#)

Please Note: Our search criteria has changed. We previously searched for Colt Network which was within 200 metres, this has now changed to 50 metres. The negative response will be for all enquiries that the network is 50 metres or more away from the place of enquiry.

Dear Sir/Madam,

Thank you for your enquiry for the above reference.

We can confirm that Colt Technology Services do not have apparatus near the above location as presented on your submitted plan, if any development or scheme amendments fall outside the 50 metre perimeter new plans must be submitted for review.

Search is based on Overseeing Organisation Agent data supplied; we do not accept responsibility for O.O. Agent inaccurate data.

If we can be of any further assistance please do not hesitate to contact us.

Kind regards,

Plant Enquiry Team



Please consider the environment before printing this email.

This e-mail and any files transmitted with it are confidential and are intended solely for the use of the intended recipient(s). If you are not the intended recipient, you must not copy, distribute or take any action based on this communication. If you have received this communication in error please contact plantenquiries@catelecomuk.com and delete this communication and any copies of it. Any views or opinions presented are solely those of the author and do not necessarily represent those of C A Telecom LTD. C A Telecom LTD monitors e-mails to ensure that its systems operate effectively and to minimise the risk of viruses.

From: Keith Smith <keith.smith@apogeeutilityconsultants.co.uk>
Sent: 22 March 2021 09:57
To: Plantenquiries <plantenquiries@catelecomuk.com>
Subject: URGENT C2 ENQUIRY REQUEST 422015 Chesswick Crescent

From: plantenquiries@psgservices.co.uk
To: [Keith Smith](#)
Subject: 422015 Chesswick Crescent
Date: 29 March 2021 12:10:16

To Whom It May Concern:

Thank you for your recent enquiry regarding your proposed work at the above location.

euNetworks Fiber UK Limited do not have plant in the vicinity of your proposed works and no strategic additions to our existing network are envisaged in the immediate future.

This information is only valid for a period of 3 months so, if your start date is 3 months or more from the date of this email, please re-apply for updated information at our generic email address

ss: plantenquiries@psgservices.co.uk.

Kind regards

ALL PLANT ENQUIRIES AND DIVERSIONARY REQUESTS SHOULD BE ADDRESSED BY EMAIL TO THE OPERATIONS TEAM AT plantenquiries@psgservices.co.uk, WITH A PLAN AND FULL POSTAL ADDRESS OF YOUR ENQUIRY, THANK YOU



For and on behalf of euNetwork Fiber UK Limited

Thanks

Vivien Hart

T 01772 514453 | **E** plantenquiries@psgservices.co.uk



Telecommunications Survey, Planning, Engineering & GIS Services

Information contained in this e-mail and any files or documents transmitted with it are confidential. They are solely for the use of the individual or entity to whom they are addressed and contain legally privileged information. You must not copy, reproduce, print, forward or disclose their contents to any other person. If you are not the intended recipient, please notify the sender immediately and delete from your computer. Any views or opinions presented are solely those of the author and do not necessarily represent those of PSG Services Ltd.

Although this e-mail and any attachments are believed to be free of any virus or other defects which might affect any computer or IT systems into which they are received, no responsibility is accepted by PSG Services Limited for any loss or damage arising in any way from the receipt or use thereof.

=====



Virus-free. www.avg.com

From: [Plantenquiries](#)
To: [Keith Smith](#)
Subject: RE: E03-21-6432 URGENT C2 ENQUIRY REQUEST 422015 Chesswick Crescent
Date: 22 March 2021 14:20:38
Attachments: [image001.png](#)
[image003.png](#)
[image004.png](#)
[image006.png](#)

Dear Sir or Madam,

Thank you for your plant enquiry below.

We can confirm that Lumen Technologies (formerly CenturyLink Communications UK Limited, Level 3, Global Crossing (Uk) Ltd, Global Crossing PEC, Fibernet UK Ltd and Fibrespan Ltd) do not have any apparatus within the indicated works area.

Instalcom responds to plant enquiries for all of the above and therefore you only need send one plant enquiry to cover all of these companies.

Please note that this response is only valid for 3 months. If your works do not commence within this time period, please resubmit your plant enquiry for assessment before any works commence.

Regards

Plant Enquiries Dept
Instalcom Limited
Borehamwood Ind. Park
Rowley Lane
Borehamwood
WD6 5PZ

Office: +44 (0)208 731 4613

Fax: +44 (0)208 731 4601

Email: plantenquiries@instalcom.co.uk

Web: <http://www.instalcom.co.uk>



From: Keith Smith <keith.smith@apogeeutilityconsultants.co.uk>

Sent: 22 March 2021 09:58

To: Plantenquiries <Plantenquiries@instalcom.co.uk>

Subject: URGENT C2 ENQUIRY REQUEST 422015 Chesswick Crescent

From: [Nraswa](#)
To: [Keith Smith](#)
Subject: RE: URGENT C2 ENQUIRY REQUEST 422015 Chesswick Crescent
Date: 23 March 2021 06:01:12
Attachments: [image001.png](#)
[image002.png](#)

KCOM Commercial in Confidence

Hello,

Location / Ref no :

Scheme Number: 422015
Location of Works: Chesswick Crescent
Postcode: DN17 4DA
O.S. Grid Ref.: 480411 , 409999
Road Name: A18

At this time the KCOM Group PLC has no apparatus or proposals for new apparatus in the vicinity of these works and will not be affected by them. Please note this reply is valid for 3 months from the date of this letter.

[KCOM now offer this service free on-line, to register for this please contact Tony Parker at \[Tony.Parker@Kcom.com\]\(mailto:Tony.Parker@Kcom.com\)](#)

Kind Regards

Pete McSherry

NRSWA Planner – Field Engineering
Mobile/Cell: +44 (0) 748 453 9186
Email: pete.mcsherry@kcom.com
Web: www.kcom.com

KCOM

From: Keith Smith <keith.smith@apogeeutilityconsultants.co.uk>
Sent: 22 March 2021 09:58
To: Nraswa <nraswa@kcom.com>
Subject: URGENT C2 ENQUIRY REQUEST 422015 Chesswick Crescent

Dear Sir or Madam,

ROADS AND STREET WORKS ACT 1991 PRELIMINARY ENQUIRY Appendix C2 of the Code of Practice (CoP) 'Measures Necessary Where Apparatus Is Affected By Major Works (Diversionary

From: [NRSWA](#)
To: [Keith Smith](#)
Subject: URGENT C2 ENQUIRY REQUEST 422015 Chesswick Crescent
Date: 22 March 2021 12:46:41
Attachments: [image001.png](#)
[image002.png](#)



Thank you for your enquiry.

Please be advised that Sky Telecommunications Services Ltd will not be affected by your proposal.

Best endeavours have been made to ensure accuracy, however if you require further information, please contact us by email at nrswa@sky.uk.

Regards



NRSWA Department
Sky UK - Technology - Operations

 nrswa@sky.uk  +44 2070323234

From: Keith Smith <keith.smith@apogeeutilityconsultants.co.uk>
Sent: 22 March 2021 09:58
To: NRSWA <nrswa.nrswa@sky.uk>
Subject: [EXTERNAL] URGENT C2 ENQUIRY REQUEST 422015 Chesswick Crescent

Dear Sir or Madam,

ROADS AND STREET WORKS ACT 1991 PRELIMINARY ENQUIRY Appendix C2 of the Code of Practice (CoP) 'Measures Necessary Where Apparatus Is Affected By Major Works (Diversionary Works)'

My client is considering a scheme involving major highway works as detailed below:

From: [SOTA Plant Enquiries](#)
To: [Keith Smith](#)
Subject: RE:S03-21- 2583 URGENT C2 ENQUIRY REQUEST 422015 Chesswick Crescent
Date: 24 March 2021 12:16:45
Attachments: [image003.png](#)
[image004.png](#)
[image005.png](#)
[image007.png](#)



Dear Sir or Madam,

With reference to your plant enquiry below, we can confirm that SOTA do not have any apparatus within the immediate proximity of your proposed works.

If you require any further information, please do not hesitate to contact us.

Please note that this response is only valid for 3 months. If your works do not commence within this time period, please resubmit your plant enquiry for assessment before any works commence.

Regards

Plant Enquiries Dept.
Instalcom Limited
Borehamwood Ind. Park
Rowley Lane
Borehamwood
WD6 5PZ

Office: +44 (0)208 731 4613
Fax: +44 (0)208 731 4601
Email: sota.plantenquiries@instalcom.co.uk
Web: <http://www.instalcom.co.uk>



From: Keith Smith <keith.smith@apogeeutilityconsultants.co.uk>
Sent: 22 March 2021 09:58

Public

Date
22032021

Contact
Telia Carrier
Infrastructure Team

check-network@teliacompany.com

Your reference: 422015

Our reference: UK_ROW_41_ZD_22032021

Dear Sir/Madam,

Responding to your Line Plant Enquiry we would like to inform you that Telia Carrier's network is not in vicinity of the location which was detailed in your enquiry.

We kindly inform you that from the 1st of June Telias inquiries handling process has changed. The new contact email is check-network@teliacompany.com instead of telenttelia.plantenquiries@telent.com. Please note that the contact postal address has changed as well please find below.

Our team is seeking opportunity to cooperate with Enquirers whose enquiries are targeting locations far away from our network. Our intention is to reduce the number of out-of-area requests and save time and manpower on both side. If you can utilize our network KMZ map to see where our network is located and to pre-filter the enquiries which are far from our network, please contact us at check-network@teliacompany.com and we will provide you a KMZ network map.

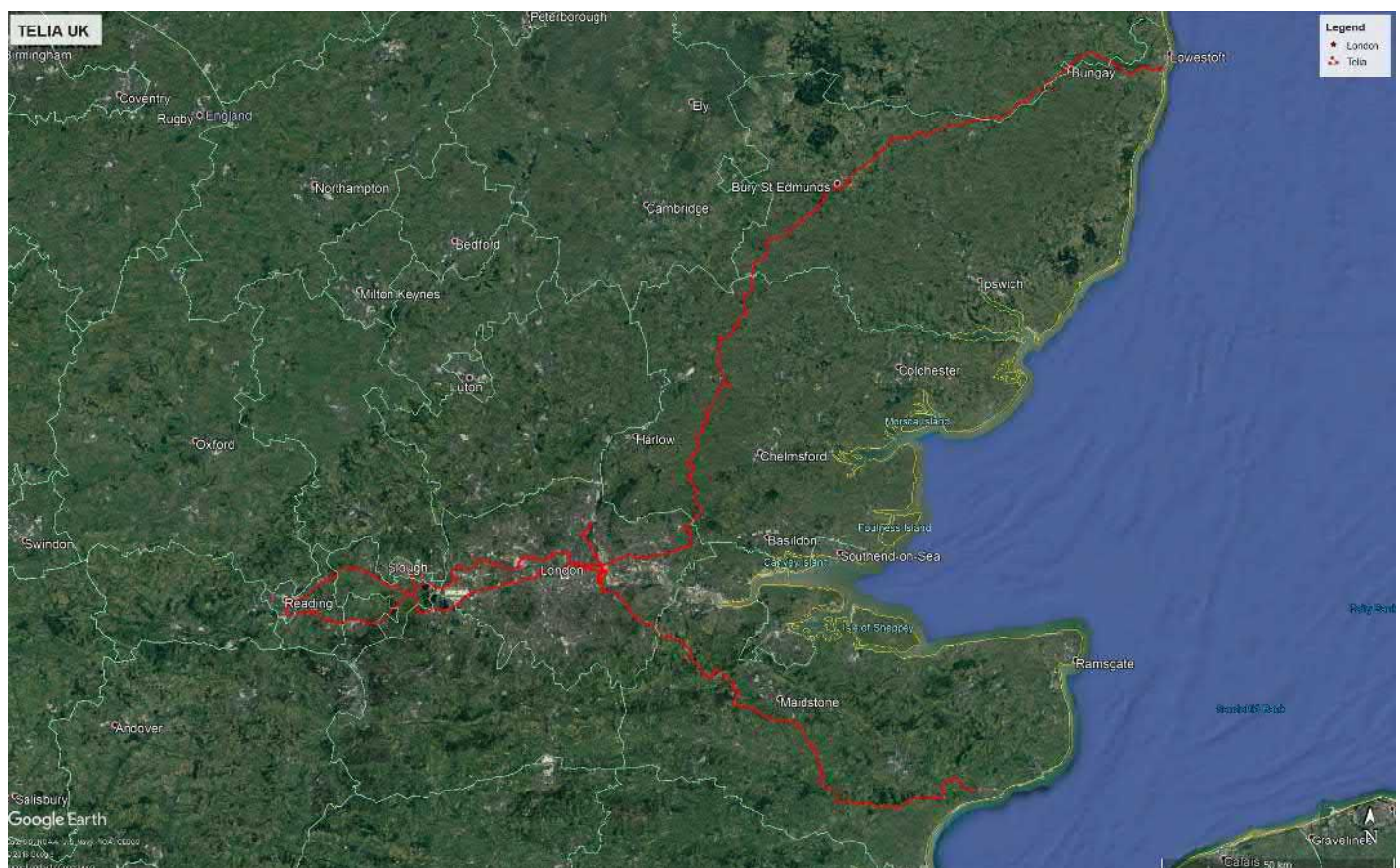

Company Information
Telia Carrier UK Ltd.
69-77 Paul Street, London, England, EC2A 4PN United Kingdom
Reg no. 2796345
VAT no. GB 628419621

Contact information
Telia Carrier UK Ltd.
Postal & Visiting Address: 3rd Floor, 69-77 Paul Street, London, England, EC2A 4PN United Kingdom
Tel 08000287406
teliacarrier.com

Public

Date
22032021

Please note that all enquiries relating to the Telia Carrier line plant should be forwarded to:

By post - to, Telia Carrier UK Ltd
69-77 Paul Street
3rd Floor
London
EC2A 4NW

By email - to, check-network@teliacompany.com

By phone - to, 08000287406
003618089955

Your sincerely

Tardos Csizmazia

GIS Officer

check-network@teliacompany.com

Telia Carrier Infrastructure Team



From: [UK OSP-Team](#)
To: [Keith Smith](#)
Cc: [UK OSP-Team](#)
Subject: RE: URGENT C2 ENQUIRY REQUEST 422015 Chesswick Crescent
Date: 22 March 2021 16:23:30
Attachments: [image001.png](#)

Dear Sir/Madam

Verizon is a licensed Statutory Undertaker.

We have reviewed your plans and have determined that Verizon (Formally known as MCI WorldCom, MFS) has no apparatus in the areas concerned.

If you have any further queries please do not hesitate to get in touch.

Yours faithfully

Plant Protection Officer E.mail osp-team@uk.verizon.com

From: Keith Smith [<mailto:keith.smith@apogeeutilityconsultants.co.uk>]
Sent: 22 March, 2021 9:59 AM
To: UK OSP-Team <osp-team@intl.verizon.com>
Subject: [E] URGENT C2 ENQUIRY REQUEST 422015 Chesswick Crescent

Dear Sir or Madam,

ROADS AND STREET WORKS ACT 1991 PRELIMINARY ENQUIRY Appendix C2 of the Code of Practice (CoP) 'Measures Necessary Where Apparatus Is Affected By Major Works (Diversiory Works)'

My client is considering a scheme involving major highway works as detailed below:

Scheme Number: 422015
Location of Works: Chesswick Crescent
Postcode: DN17 4DA
O.S. Grid Ref.: 480411 , 409999
Road Name: A18
From: A18
To: A18
Description of Works: Utility Work
Expected Start Date: 30th March 2021

Plans showing the area for the works are attached

In order that all reasonable precautions may be taken to avoid risk to health and safety through contact with any of your existing apparatus during execution of the proposed works, please indicate the position and depth of your apparatus in the locality of the proposed works and return the plan to this office.

Map

Satellite

Home

Back

dn17 4da

Search

15 / 1 / 1 / 1 / dn17 4da

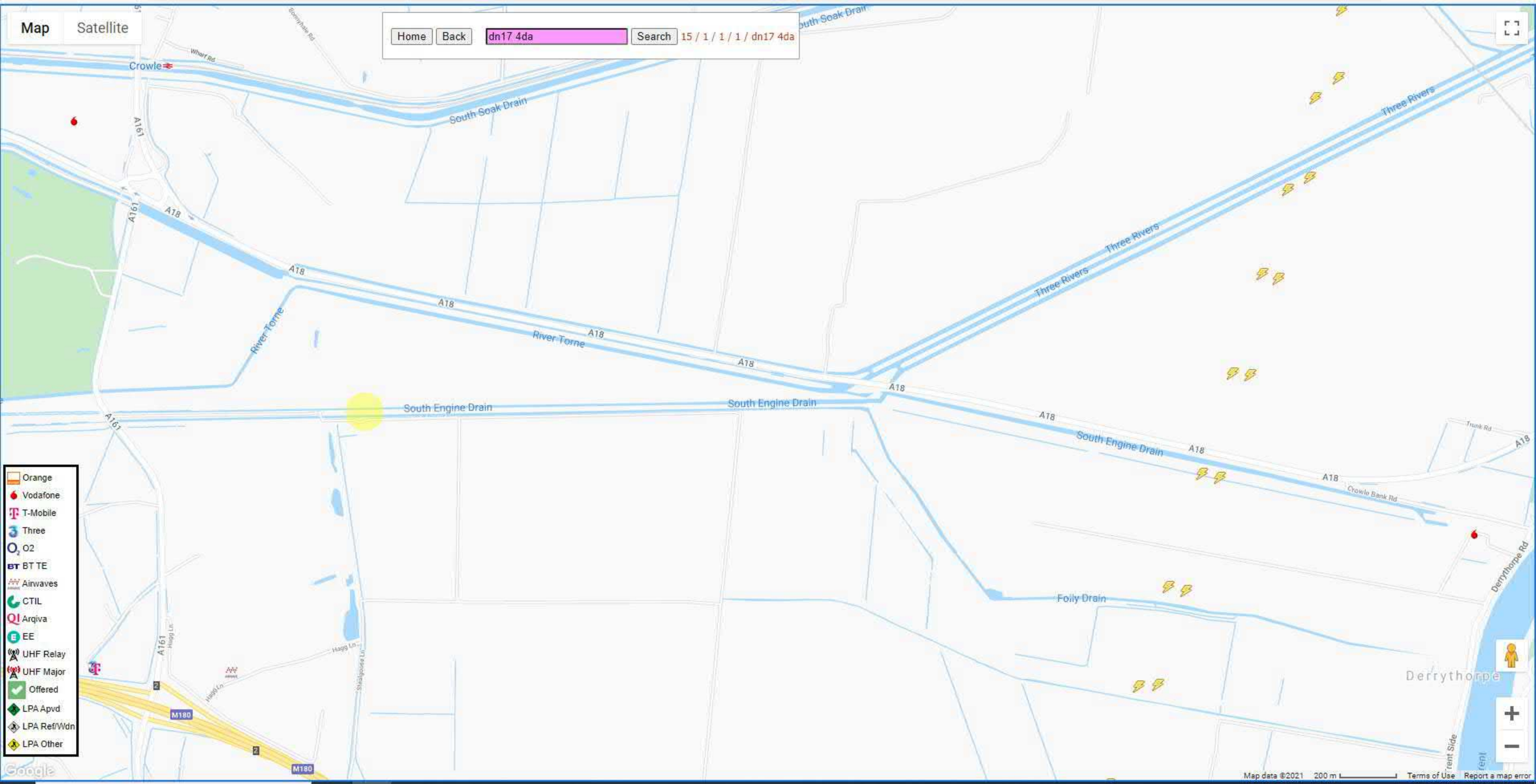

- Orange
- Vodafone
- T-Mobile
- Three
- O2
- BT
- Airwaves
- CTIL
- Arqiva
- EE
- UHF Relay
- UHF Major
- Offered
- LPA Apvd
- LPA Ref/Wdn
- LPA Other

Google

Property address

A18 FROM A161 TO ALTHORPE, CROWLE, NORTH LINCOLNSHIRE, DN17 4DA



Cancel Previous

Next

Recommended actions

We can confirm your boundary is:

- located off the coalfield
- not within the Cheshire Brine Compensation District

Cancel Previous

Next

Screen reference: MRP410

Acronyms Key

Electric			
DNO	Distribution Network Operator	KVA	Kilo Volt Amperes
IDNO	Independent Distribution Network Operator	MVA	Mega Volt Amperes
ICP	Independent Connections Provider	AC	Alternating Current
LV	Low Voltage	S/S	Substation
HV	High Voltage	PMT	Pole Mounted Transformer
EHV	Extra High Voltage		
Water			
SLO	Self Lay Organisation	WRAS	Water Regulation Advisory Scheme
Incumbent	Local Water or Water & Sewerage Company		
Gas			
GT	Gas Transporter	LP	Low Pressure
IGT	Independent Gas Transporter	MP	Medium Pressure
UIP	Utility Infrastructure Provider	IP	Intermediate Pressure
PRS	Pressure Reducing Station (Governor)	HP	High Pressure
Others			
AP	Apogee Property & Utility Consultants	CATV	Cable Television
PE	Polyethylene	FOTP	Fibre to the premise
DI	Ductile Iron	FTTC	Fibre to the cabinet
ST	Steel	l/min	Litres per minute
CI	Cast Iron	H&S	Health & Safety
SI	Spun Iron	HBF	House Builders Federation
HPPE	High Performance Polyethylene	TPO	Tree Preservation Order
MDPE	Medium Density Polyethylene	TBC	To be confirmed
GRP	Glass Reinforced Plastic	N/A	Not Applicable

Important Information

Relevant Documents

The following documents must be referred to before work commences in the vicinity of existing services:

- Health and Safety Booklet HS (GS) 6 Avoidance of Danger from Overhead Electric Lines.
- General Safety Measures to Avoid Injury and Damage to Gas Apparatus.
- HSE Guidance Note HS (G) 47 Avoiding Danger from Underground Services.
- National Joint Utilities Group (NJUG) Publications Vol. 1.
- CDM Regulations 2015.
- PAS 128:2014 Specification for Underground Utility Detection, Verification and Location.

Basic Risk Assumption for all Services

When dealing with existing services the following assumptions must always be accepted:

- All existing buildings have gas, water electric and telecoms supplies to them until proven otherwise.
- Any supply to an existing building, no matter how old the building is or how deteriorated the supply may appear, is taken to be 'live' until proven otherwise.
- All open land, vacant lots and derelict sites are deemed to have services beneath them until proven otherwise.
- The only acceptable proof that a service is 'dead' and can be removed is written confirmation from the owner of the service.
- The quality and accuracy of information provided by utilities about their existing plant is indicative and no warranty is made as to its accuracy. Therefore, any utility asset maps and/or marked up drawings provided by each utility must only be used as a guide and the actual location of plant should be verified by CAT Scan GPR survey or trial holes before construction works commence.

Please note not all service connections are shown on the utility asset [maps](#).

Plant Found Within Site Boundaries

Where utility plant is found within the site boundary, it is recommended for the client to check for legal easements or wayleaves a Wayleave search service is available from us please ask for a quotation.

Diversions of plant within site boundaries can be expensive and time consuming to relocate. Further investigation of costs and timescales are recommended. Please ask us for further details.